

The Wireless World

THE
PRACTICAL RADIO
JOURNAL
22nd Year of Publication

No. 701.

FRIDAY, FEBRUARY 3RD, 1933.

VOL. XXXII. No. 5.

Proprietors: ILIFFE & SONS LTD.

Editor:
HUGH S. POCKOCK.

Editorial Offices:
116-117, FLEET STREET, LONDON, E.C.4.
Editorial Telephone: City 9472 (5 lines).

Advertising and Publishing Offices:
DORSET HOUSE, TUDOR STREET,
LONDON, E.C.4.

Telephone: City 2846 (17 lines).
Telegrams: "Ethaworld, Fleet, London."

COVENTRY: Hertford Street.

Telegrams: "Cyclist, Coventry."
Telephone: 5210 Coventry.

BIRMINGHAM:

Guildhall Buildings, Navigation Street, 2.
Telegrams: "Autopress, Birmingham."
Telephone: 2970 Midland (3 lines).

MANCHESTER: 260, Deansgate, 3.
Telegrams: "Iliffe, Manchester."
Telephone: Blackfriars 4472 (4 lines).

GLASGOW: 26B, Renfield Street, C.2.
Telegrams: "Iliffe, Glasgow."
Telephone: Central 4857.

PUBLISHED WEEKLY. ENTERED AS SECOND
CLASS MATTER AT NEW YORK, N.Y.

Subscription Rates:

Home, £1 1s. 8d.; Canada, £1 1s. 8d.; other
countries abroad, £1 3s. 10d. per annum.

As many of the circuits and apparatus described in these
pages are covered by patents, readers are advised, before
making use of them, to satisfy themselves that they would
not be infringing patents.

CONTENTS

| | Page |
|--|------|
| PROGRAMMES FROM ABROAD, pp. I—XXIV | |
| Editorial Comment | 79 |
| The Evolution of the Gramophone | 80 |
| Pick-up Circuits | 84 |
| The Radio-gramophone of To-day | 86 |
| Unbiased | 88 |
| News of the Week | 89 |
| Modern Practice in Pick-up De- sign | 90 |
| Amplifier Designs | 92 |
| Types of Gramophone Motors | 97 |
| Choosing a Record Changer | 98 |
| Practical Hints and Tips | 99 |
| Synthetic Sound | 101 |
| Broadcast Brevities | 102 |
| Readers' Problems | 104 |

EDITORIAL COMMENT

Broadcasting Hours

Should They Be Continuous?

FROM time to time the question of broadcasting hours becomes a topic for discussion, and opinions differ widely as to how many hours a day broadcasting should be "on tap." Some people are in favour of "continuous performance" which will provide for all B.B.C. stations to be on the air from early morning till late at night with no interruptions. On the other hand, there are those who consider that if we had only a few hours' broadcasting every day the programme organisers would have a chance of putting out the very best programmes possible, and that the public would, as a result, learn to treat broadcasting with more respect and value the entertainment provided.

There is much to be said in support of either of these two extreme views. We can well recollect that in the early days of broadcasting it was quite the custom to make special efforts to arrange other commitments so as not to interfere with listening to some special items of the broadcast programme. From time to time we have recommended that the B.B.C. should make a greater effort to announce, in advance, important broadcasts which they are arranging. The very fact that broadcasting can be listened to at almost any time tends to make the listener indifferent, whereas strictly limited hours of broadcasting might do much to encourage more regular listening and would also facilitate a raising of the general standard of the programmes. To fill every hour of the day with a variety of transmissions, all up to a high standard, would be a task probably beyond the reach of fulfilment, even if talent and money were far more plentiful than at present.

The experiment might be tried by the arrangement, say, once a week, of a couple of hours' transmission which the B.B.C. would announce as their best effort.

Interference

Procrastination Must End

IN spite of the urgent need for control over electrical interference and the very widespread public concern at the rapid increase of this nuisance, certain electrical associations seem to be unwilling to show real enthusiasm to co-operate. Probably it is felt by the officials of these organisations that any compulsory modifications to electrical equipment offered for sale will prove an embarrassment to the electrical manufacturer, and that consequently the longer any compulsion in this direction can be delayed the better it will be for their membership.

This is surely a very short-sighted view to adopt. It is inconceivable that electrical interference can be permitted to continue indefinitely, when almost every member of the public is interested in wireless reception and suffers, to a greater or lesser degree, from the effects of electrical disturbances. Facing the fact, therefore, that interference has got to be stopped, or at least curtailed in the future, it is far better that remedies should be found at once. The longer this is delayed the more expensive it is going to be for the electrical industry as a whole.

General co-operation on the part of the organisations representing the electrical industry would pave the way for immediate action to the benefit of everyone concerned, and it would especially remove prejudice against electrical apparatus which is at present growing because of the nuisance of interference.

The

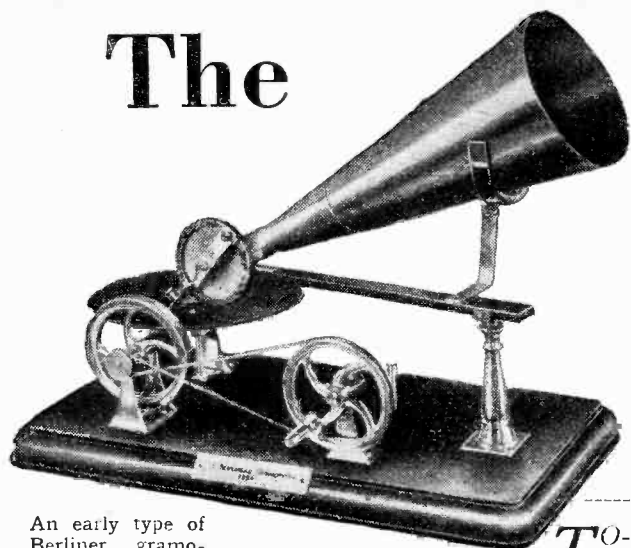

An early type of Berliner gramophone.

IT is a far cry from a wavy line inscribed by a hog's bristle on a lamp-blackened sheet of paper to the modern radio-gramophone. The former was the first recording of the human voice—the latter, as we all know, is the latest form of reproducer. In 1857 a French printer, Leon Scott, conceived the idea that he might be able to fix a sound wave upon paper. He wrapped round a drum a sheet of paper smeared with lamp-black; to a stretched goldbeater's skin he attached by sealing-wax a hog's bristle which rested on the surface of the paper. In front of the crude diaphragm he mounted a horn. Scott found that when he rotated the drum and spoke into the horn a wavy line was traced in the lamp-black and surface of the paper. He noted that if he did not speak the line was straight. He also discovered that repetitions of the same sound gave the same tracings. Scott called the tracings in the blackened paper the "Phonautograph," and deposited with the Academy of Sciences in Paris an article entitled the "Principles of Phonautography."

Although in this treatise he expressed the hope that it would be possible to record and subsequently reproduce sound, he did not specify any methods by which this might be brought about. The crude tracings made by this French printer were, in fact, the first lateral recordings of the human voice, upon which the gramophone is based.

The Phonograph

Another Frenchman, Charles Cros, deposited a treatise with the Academy of Sciences eighteen years later, entitled "The Process of Recording and Reproducing Audible Phenomena." Although he did not demonstrate his invention practically, he described the principles upon which the "Phonograph" was subsequently founded.

The scene of the development of the talking machine then passed to America, where, in July, 1877, Edison first recorded his voice by embossing a paraffin paper wrapped round a drum. In August he drew a sketch of his first "Phonograph,"

Evolution of the Gramophone

From the Early Talking Machine to the Modern Radiogram

By RICHARD ARBIB

(The Gramophone Company)

TO-DAY the gramophone has become such a normal adjunct to civilised existence that the public may be forgiven for accepting it without considering the slow and laborious process which has led to its ultimate development in the modern highly complex radio-gramophone. Eighty years have now elapsed since its fundamental principles were first made the subject of experiment.

which was made to his specification by a mechanic, Krusei, for eighteen dollars. This machine is now in the South Kensington Museum. In this instrument a cylinder is mounted in the centre of a threaded spindle, which passes through two uprights fixed to a wooden base. The male thread of the spindle passes through a female thread in one of the uprights, and to the end of the spindle is attached a small handle. On one side of the cylinder is mounted a ferrotyp plate, in the centre of which is a sharp steel needle.

This diaphragm was intended for recording; on the other side of the cylinder was mounted a paper diaphragm, to the centre of which was fixed a rounded pin. Both these crude forms of needles were adjustable by springs to make contact with the cylinder. A sheet of tinfoil was wrapped round the cylinder, and the sounds of the voice indented thereon. Although Edison's "Phonograph" excited considerable interest in its early days, it did not become a commercial success, for its sponsors did not appreciate its entertainment value, and only exploited it as an adjunct to business, to replace, for instance, stenographers. The indenting of the tinfoil introduced distortion into the voice, and for fifteen years the "Phonograph" was only regarded as a scientific toy.

The Graphophone

Other inventors were now striving to produce a better machine, and in 1885 the "Graphophone" was patented by C. M. Bell and C. C. Tainter, of telephone fame. Their instrument was very similar to Edison's, but the difference between

their records and those of Edison's was that, whereas Edison's were indented by an up-and-down line, the "Graphophones" were cut by an up-and-down line. Both the "Phonograph" and the "Graphophone" cylinder records employed "hill and dale" recording, the track being of uneven depth.

Two years later The American Graphophone Company (later The Columbia Graphophone Company) was formed to market machines and wax cylinder records made under Bell and Tainter patents. These inventors had, in the previous year, filed an application for the use of wax and a sapphire point as the material and instrument for cutting a record. Litigation between Bell and Tainter and Edison followed, culminating in a working agreement between the two parties.

Other talking machines began to make their appearance, and in 1892 Charles Stroh demonstrated in London the first portable "Phonograph."

On this machine, the original of which is in the H.M.V. Museum at Hayes, disc records were used, although

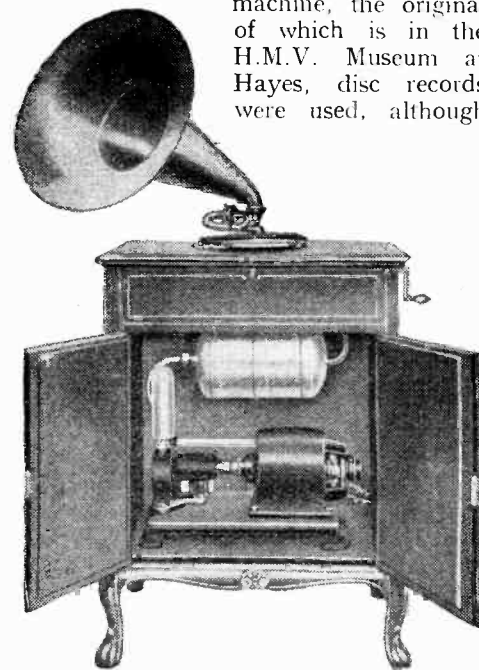

The Auetophone with auxiliary blower to give increased output.

they were indented by a sapphire point. No inventor, up to this time, had realised that it was necessary to discover the method by which many duplicates could be made of an original recording.

The Evolution of the Gramophone

On November 12th, 1887, Emile Berliner, a German subject, who had emigrated to America at an early age, filed his first patent for the "Gramophone." He had, after inspecting a model of the Leon Scott "Phonograph" at a local museum, become convinced that the future of the talking machine rested in a lateral-cut record; that is, one in which the sound waves were traced in a wave-form of even depth on a surface instead of being indented in the surface.

He also decided that it was necessary to discover a method by which thousands of duplicates could be made from one matrix. Berliner's first records were made by covering a small paper-covered cylinder with soot from a lamp. After the voice had been recorded thereon he fixed the tracings by putting on a shellac solution. He cut the paper tube into strips and arranged for a photo-engraver to etch the tracings into a piece of flat zinc. He then considered his first crude gramophone in order that he might test his theory that the human voice could be reproduced through a lateral-cut record. He took a telephone receiver, and, after sawing off the front, he affixed to the diaphragm a stylus, at the end of which was attached a steel pin. By moving the point of the pin over the photo-engraved lines on the zinc by hand he was able to reproduce snatches of his own voice from the flat piece of zinc.

Berliner then proceeded to construct a gramophone with a turntable similar to those with which we are so familiar. This machine was hand-driven, but had a fly-wheel which assisted in obtaining constant speed. By means of a round glass plate, blackened over by smoke, a flat, circular record was made, and by a photo-engraving process the first flat disc record suitable for reproduction came into existence.

Master Records

It was at this time that Berliner discovered that the grooves of the record itself were sufficient to take the sound-box across the disc. He included this observation in his patent, and for many years it was a master patent of the "Gramophone." The inventors of the "Phonograph" and "Graphophone" had used screw mechanisms to take the needle across the record.

Although Berliner realised that it would be simple to make a matrix by recording in wax and then depositing it in an electrolytic bath and growing a copper negative, he was prevented from carrying out his theory by the fact that Bell and Tainter had already patented the methods for recording on a wax surface. Up to 1901 Berliner's master records were made by covering zinc discs with a composition of

beeswax. After the lateral tracings had been made from that, the record was placed in an acid bath and the sound tracings etched. The matrix was then made by a copper deposition, and the first records pressed in celluloid. Subsequently, records were made in vulcanised rubber, and eventually in a shellac composition.



Marketed in 1924—a gramophone embodying the Lumiere diaphragm.

First Motor and New Sound-box

In 1897 Berliner's chief inventive work in connection with the gramophone had been accomplished, and its rapid development as a commercial instrument then passed into the hands of two of his colleagues. A year previously, Alfred Clark, who had originally worked with Edison, but, realising the immense superiority

of the lateral-cut record, had transferred his activities to Berliner, had taken out a patent for the use of a governor in conjunction with the hand-driven gramophone.

Berliner and Clark realised that it was necessary to incorporate a suitable spring motor before the gramophone would become a commercial success for home entertainment, and Clark therefore set forth to find a machinist who could produce a suitable motor. Spring motors had been fitted to the early phonographs,

but none of them had been satisfactory owing to excessive noise and uneven running. His first visit was to the workshop of Eldridge R. Johnson, a machinist, in Camden, New Jersey.

After a few weeks' experimenting, Johnson produced a satisfactory sample motor, and then made supplies for all the early Berliner gramophones. Alfred Clark had by this time realised that the first Berliner sound-box was very unsatisfactory; the stylus bar was clamped across the face of the box, and was held so rigidly that after a few playings a record was completely worn out. Despite the great improvements in record matrix making and record pressing (due principally to the substitution of shellac composition pressing material for vulcanised rubber), the inefficiency of this sound-box did not enable the best results to be obtained from the improved records. Clark realised that a much lighter and freer stylus bar was necessary, and worked out an experimental model. He then handed this to Johnson, who perfected it in order that commercial models could be produced.

Wax for Recording

Clark-Johnson sound-boxes were introduced on the Berliner gramophones in 1897, and remained as standard until 1902 when a modified box was introduced to cope with the further improved records owing to the adoption of wax as a recording material. It is interesting to note that the development of these two sound-boxes was due to improvements in records. In fact, throughout the history of the gramophone, the development in instruments has followed the improvements in recording.

The Clark-Johnson sound-box is probably the most familiar in the world, for it was the one fitted to the small gramophone in the famous "His Master's Voice" picture. The incorporation of the spring motor and the introduction of the Clark-Johnson sound-box were responsible for the rapid hold that the gramophone gained on the public between 1897 and 1903. It is also interesting to note that these two colleagues of Berliner's, Johnson and Clark, were to become the founders of the two largest gramophone companies in the world. In the first year of the twentieth century the Victor Talking Machine Company was formed in Camden in order that Berliner patents and the Johnson improvements of these patents could be combined in one corporation. Eldridge R. Johnson became its president, and remained so up to 1926.

In 1909 Alfred Clark became managing director of The Gramophone Company in London, and is now chairman of the great merger company, Electric and Musical Industries, combining the interests of "His Master's Voice," Columbia, Marconiphone, Parlophone, and Regal-Zonophone.

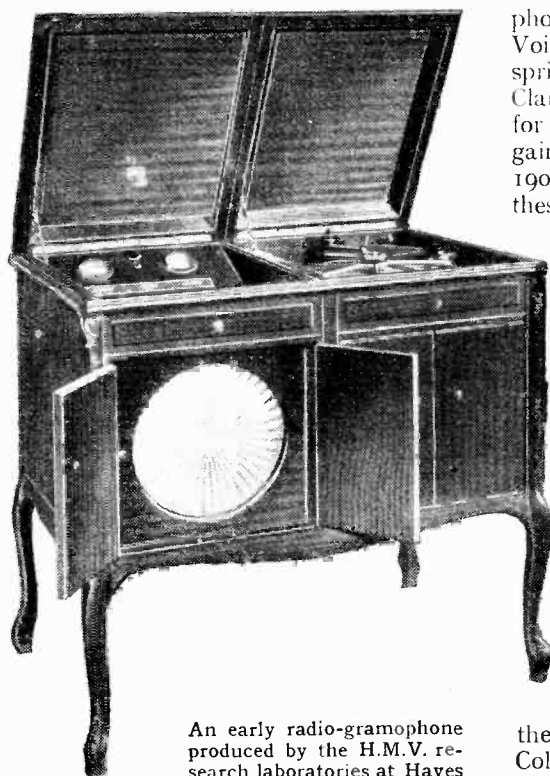

An early radio-gramophone produced by the H.M.V. research laboratories at Hayes in 1923.

The Evolution of the Gramophone—

By 1902 the Bell and Tainter patents for sound recording had expired, and lateral disc recording on wax then became universally used in place of the old etching in zinc method. Great artists, such as Caruso, Melba, and Patti began to record for the gramophone, and thus the talking machine became to be appreciated as an instrument of entertainment. On the record side there was no great step forward between the years of 1902 and 1925, with the exception of the introduction of a practically non-scratch record by the Columbia Graphophone Company in 1922.

Early Public Address Gramophones

The quality of reproduction from the gramophones likewise did not meet with any great improvements. In 1903 the first instrument to incorporate a tone arm was placed on the market, and by 1905 two types of gramophones were evolved for playing music to large crowds of people. The first, the "Triplephone," required a great deal of skill for satisfactory operation. Three turntables were mounted on top of one another and driven by a single motor, a separate horn and sound-box was played from each record, and it was naturally necessary to ensure that the needles were placed on the same copies of the records in exactly the same place.

A very much more expensive machine,



Produced at Hayes in 1920 and believed to be the first experimental automatic record changer. Five records could be handled.

the "Auxetophone," enjoyed considerable popularity for some years. In this instrument a small air valve replaced the mica-diaphragm in the sound-box. An electric motor actuated bellows which pumped air past the valve at a pressure of 2 lb. per square inch. The sound from the record was, in point of fact, blown out of the horn by compressed air.

Up to 1911 the horns of gramophones

had been external, but manufacturers then realised that, however beautiful they might make the cabinets, the horns could not fail to be other than ugly in the home. Internal horn machines then made their appearance, and, although they increased the popularity of the gramophone commercially, it cannot be said that their reproduction was as good as their predecessors. The horns had to be limited in size and bent to fit into the cabinets. There was, in fact, little improvement in quality of reproduction between the years 1906 and 1924. To make the gramophone even more attractive, attention was directed to automatic record changing, and in 1920 the first experimental design was produced at the H.M.V. works at Hayes. Eldridge R. Johnson, whilst on a visit to England from America, had conceived the idea of the automatic gramophone,

and made sketches of the instrument. On arrival at Hayes they were handed over to a mechanic named Tompsett, who, in a fortnight, had produced a working model. Five records were mounted on top of one another on a turntable and rejected after playing. The instrument was driven by a spring motor. The directors of the company did not think the time was ripe for an instrument of this kind, but between the years 1920 and 1927, when the first automatic gramophone was introduced to the public by H.M.V., twelve different experimental models had been produced at Hayes.

At the same time experiments were taking place in the development of a large-diaphragm gramophone. Before the War the Pathé Company in France had introduced a gramophone in which their "hill-and-dale" disc records were played upside down by a needle attached to the centre of a paper cone. The Gramophone Company acquired the patents for a pleated diaphragm reproducer from a French experimenter, Lumiere, and after four years' experiment at Hayes the first Lumiere gramophone was marketed in 1924. A special paper diaphragm was pressed, folded, and then dipped into an acetate solution. The diaphragm was mounted upright at right angles to the record, and was supported by a ring which was car-

ried by an arm across the face of the disc, a needle was fixed in a stylus which was connected by a long wooden bar through a bell-crank lever fastened to the centre of the diaphragm. The reproduction from this machine was a relief from the rather hollow horn quality the public had been accustomed to up to then.

By 1923 the first experimental single-dial combined wireless and gramophone had been produced in the Research Laboratories at Hayes. B. Mittell, who

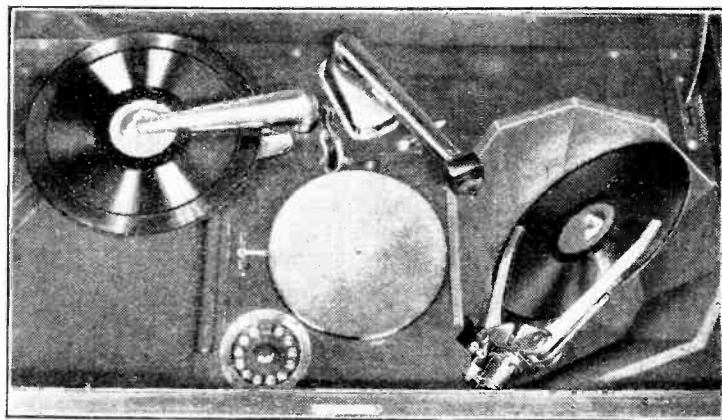

H.M.V. automatic record changer with record turning-over device. This model has not been placed on the market.

had recently joined the company, had taken charge of electrical research. After months of experiment he evolved a method of cam control which adjusted the capacity of a single condenser and simultaneously carried the reaction coupling. Many instruments in the United States and other countries used this patent. This early radio-gramophone was not produced commercially, for within a few months the possibilities of recording by an electrical process was engaging the whole attention of the Research Departments of the large gramophone companies. In July, 1925, the first electrically recorded records were issued in England by "His Master's Voice." Once again an improved method of recording demonstrated how inefficient were the reproducing instruments.

Matched Impedances

By the end of the year the new gramophones embodying long horns and the partial use of matched impedance were placed on the market. Up to this time the construction of horns and sound-boxes had been by trial-and-error methods. In the Bell Laboratories in America two engineers, Maxfield and Harrison, had turned their attention to the scientific production of logarithmic horns used in connection with scientifically produced sound-boxes. The new "His Master's Voice" machines were a development of these experimenters' researches. Two years later these models were replaced by ones in which the principles of "matched impedance" were applied throughout from the stylus bar of the sound-box to the mouth of the horn. An unobstructed pathway for the sound waves from the tip of the needle to the outer opening of the horn was obtained. The sound-box was

The Evolution of the Gramophone—

matched to the tone arm, and the components were matched to each other, and there was no reflection of the sound waves during their passage through the gramophone.

In these machines all-metal sound-boxes were employed in which specially constructed aluminium diaphragms reduced edged stiffness, and enabled a large area of the diaphragm to vibrate evenly. This gave improved reproduction of the bass notes, and the flexibility of the stylus bar reduced record wear by enabling the needle to track the larger sound waves of the electrically recorded records. By a clever method of folding, a truly exponential horn of six and a half feet in length was fixed in an ordinary cabinet gramophone. This type of tone chamber was called the "Re-Entrant." At the same time the Columbia Graphophone Company had commenced to market gramophones in which bifurcated horns were used in conjunction with new sound-boxes.

Meanwhile, experiments had taken place in the electrical reproduction of records, and, although experimental pick-ups had been produced at Hayes as early as 1923, the first electrical reproducer to bear the H.M.V. trade-mark did not make its appearance until 1927. A year previously the Brunswick Company had begun to market the "Panatropé," the first commercial machine to utilise an electrical pick-up, amplifier, and loud speaker for reproducing records.

Freak Machines

The "boom" years of the gramophone, 1927-1928, led to numerous companies being floated for exploiting some extraordinary machines. In many cases only experimental models were produced, and all the companies had short lives. An automatic gramophone which played records vertically, a portable gramophone which went back to the old cone diaphragm method of reproduction, and records which reverted to the original celluloid base, were a few of the products for which company directors prophesied abundant sales. Most of us will be familiar with the progress during the last four years; the combined instrument—the radio-gramophone—is now made by many manufacturers, and has established itself as an instrument of very wide appeal both for the home and for general entertainment purposes.

Automatic record changers have been simplified, and now occupy little more space in the cabinet than the ordinary electric motor. In view of the frequent cry for a changer that will turn records over, it is interesting to note that an experimental model was demonstrated before the Royal Society of Arts in March, 1931. This instrument, produced in the H.M.V. Research Laboratories, can be set to play twelve records, ten- or twelve-inch mixed, in succession. By pressing a button on a remote volume control, either one side only or both sides can be played at will. It should be emphasised that the machine is unlikely to be produced commercially, as

the cost of production is hardly justified. Compact automatic mechanisms can now be produced so cheaply for playing complete works which are specially pressed for use on automatic machines. Progress in the development of the radio-gramophone is unlikely to be so rapid in the future as it has been during the last five years. Excellent reproduction with satisfactory operation can now be obtained for a comparatively small sum.

In a short article of this nature it has only been possible to sketch briefly the development of the gramophone.

Readers who are anxious to learn more of the interesting history and development of the talking machine are referred to the following publications, some of which may be out of print:—"Modern Gramophones and Electrical Reproducers," by P. Wilson and G. M. Webb; "The Romance of the Gramophone," by T. Lindsay Buick; "Emile Berliner," by F. W. Wile; "The Reproduction of Sound," by Henry Seymour; and Cantor Lecture delivered by A. G. D. West before the Royal Society of Arts on the "Recording and Reproducing of Sound."

FERROCART COILS IN GERMANY



(1) The Ferrocart discs are sawn into two parts.
 (2) Sorting the cores into categories according to their magnetic properties.
 (3) Winding the coils on removable formers; adjacent turns are secured by adhesive.
 (4) Inserting the two halves of the Ferrocart core.
 (5) Matching by variation of the air gap (see inset).

THESE photographs, from our Berlin correspondent, show various stages in the manufacture of the new high-efficiency tuning coils wound on iron-powder formers, and disclose the secret of how the Ferrocart core is placed inside the winding—a problem akin to that of the apple and the dumpling. The initial sorting of cores into categories is necessary because individual specimens vary slightly in their magnetic properties. Each category requires a slightly different number of turns of wire for a given inductance value. Instead of winding the coil directly on the core, it is first wound on a mandrel, or removable former, and the two sections of the Ferrocart disc are then inserted.

The critical operation of inductance matching is carried out with the help of oscillators and a means for making fine air-gap adjustments by rocking one section of the coil. Finally, the sections are secured by filling up the gap with a sealing compound.

Pick-up Circuits

Gramophone Reproduction from the Radio Receiver

THE electrical reproduction of gramophone records offers such striking advantages over purely mechanical methods that it is not surprising to find it becoming more and more generally employed where high-quality reproduction is required. Any wireless receiver capable of giving good quality at a reasonably large volume can readily be modified for the electrical reproduction of records. Apart from the motor and turntable, which will often be available from an existing mechanical gramophone, the only essential components are a pick-up and a volume control potentiometer. Since most present-day sets include a detector valve transformer coupled to the output pentode or triode, and these will provide sufficient amplification for any normal type pick-up, it is necessary only to connect the extra components to the input of the detector valve.

In the case of a battery receiver the connections are simplicity itself, and are illustrated both diagrammatically and pictorially in Fig. 1. The potentiometer R is provided for the volume control, and it can with advantage be of the specially graded type, so that the changes of volume are even throughout the range. The straight-line type, however, is quite as satisfactory electrically, but it is not so pleasing in its operation. The really important point is the value selected for its total resistance, since it can have a marked effect upon the quality of reproduction. If the resistance be less than a certain value, which depends upon the type of pick-up, the higher musical frequencies will be greatly attenuated, and it is wise, therefore, to adhere to the pick-up makers' recommendations in this respect.

It is possible, however, to turn this effect to useful account, for it often happens that the high notes are unduly strong—particularly in cases where the output valve is a pentode. By using a volume control of lower resistance than usual, or, alternatively, by shunting the pick-up by a variable resistance as shown in Fig. 2, the high-frequency response can be reduced to the desired degree. In the majority of cases, therefore, some experimenting with different resistance values will be well repaid.

Automatic Bias

In a battery set it will suffice if the bias battery has a potential of 1.5 volts, but in the case of a mains set, to which the same connections are applicable, 3 volts bias should be used. This, of course, is due to the fact that with most mains valves there

By W. T. COCKING

is a flow of grid current until the grid is at least 1 volt negative with respect to its cathode, whereas with battery valves grid current ceases at about zero bias. In general, however, it is desirable to employ automatic bias in a mains set, and the circuit of Fig. 3 should then be used. The bias resistance can be given a value of 1,000 ohms, since this value covers all normal type detector valves, such as the M.H.4, M.H.L.4, AC/HL, 354v., 165v., and 41MHL.

The results obtainable with these simple circuit arrangements represent a considerable improvement upon the usual mechanical reproduction, but a closer acquaintanceship with the apparatus reveals that there is something lacking, and the quality rarely comes up to the standard set by broadcasting. The usual defects are—needle scratch, hard quality, and rattling, and of these the latter is often the most annoying.

frequencies it is due to the needle being unable to follow the groove of the record, showing poor pick-up design. Increasing the weight of the pick-up will help.

The general type of rattle, however, is at a high frequency, and it is due largely to radiation from the needle and its holder. By the very nature of the pick-up these must vibrate in accordance with the dictates of the recording, and they will consequently act upon the air and set up

vibrations in it. At low frequencies they can move an insufficient quantity of air for the sound to be audible, but this is far from being the case at high frequencies. Musical notes in the neighbourhood of the natural resonance frequency of the needle and its

holder are most strongly reproduced by this direct means, and it is a common experience that, with the amplifier switched off, the recording can be followed by the direct radiation from the pick-up.

When the amplifier is working and the volume level is high, this radiation is drowned, and may be of no importance. In cases where only moderate volume is required, however—and these are the most common—both the direct radiation and the output of the loud speaker can be heard, and they interfere with one another

to produce a distressing rattling effect. There is one cure, and one only: the pick-up must be enclosed in a sound-proof cabinet. A simple lid covering the playing-desk affords an appreciable reduction in the noise, but to obtain complete freedom it is usually essential for the lid to be thoroughly packed with felt.

We come now to the second source of trouble—harsh reproduction. This is usually due to the high-frequency resonance of the pick-up, which accentuates unduly those frequencies in the neighbourhood of 3,500 cycles. The harshness may be reduced by the simple expedient of lowering the general high-frequency response, either by shunting the pick-up by a low-value resistance or by fitting one of the standard type scratch filters. At best, however, these remedies are only partial,

NEARLY every receiver is capable of giving good reproduction when a gramophone pick-up is connected. It is, however, important to consider the value of the volume control resistance which, if incorrect, may affect the frequency response. A needle scratch filter and resonance eliminator are also given consideration in this article.

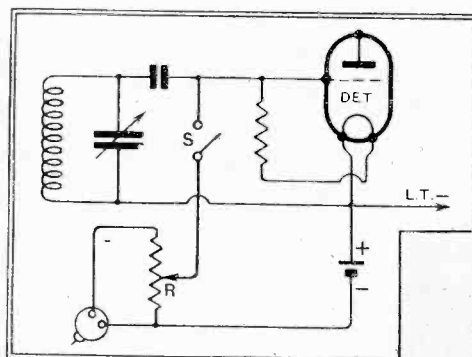
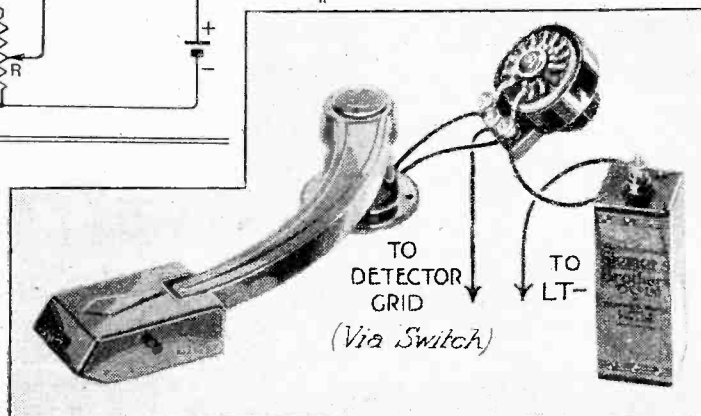

Fig. 1.—The ease with which a gramophone pick-up can be fitted to a battery set is depicted in these illustrations. The switch S is not essential, but it saves disconnecting wires when radio reception is required.



It is, of course, assumed that the amplifier itself is free from blame, for this is a trouble which cannot be taken into account in this present article. If the performance is satisfactory on radio, however, and the gramophone connections are correctly made, it is usually safe to regard the amplifier as above suspicion. The rattle which is so common is due to the purely mechanical chatter of the pick-up, and it may be of two kinds. If it occurs at low

Pick-up Circuits—

for if the resonance be sufficiently reduced the really high frequencies are obliterated altogether. A better method is to fit a tuned acceptor circuit to the pick-up, so that only those frequencies close to the resonance are reduced, and both lower and higher frequencies are left untouched.

Needle scratch is the next point of importance. It is undoubtedly of high frequency in its origin, and the usual method of eliminating it is to fit a low-pass filter to prevent all frequencies above a certain limit from being reproduced. The difficulty comes in deciding where this upper limit shall be. The frequencies recorded extend up to some 5,000 cycles, but if we reproduce these fully, and cut-off only at a higher

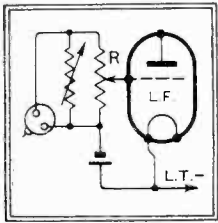

Fig. 2.—A variable resistance may be connected in parallel with the pick-up if the reproduction is too high-pitched.

frequency, most of the scratch will still remain. On the other hand, if we cut out most of the scratch we shall also remove most of the frequencies above about 3,000 cycles. As a result, the usual scratch filter is a compromise, and a reduced response is obtained above about 2,500 cycles and some scratch is allowed to remain.

Pick-up Resonance

It was recently pointed out in this journal, however, that the greater portion of the scratch is caused by the high-frequency resonance of the pick-up, and that if this resonance could be removed the majority of the scratch would also vanish. We thus come back to the tuned acceptor circuit mentioned above, and practical tests show that this is capable not only of removing the harshness due to the high-frequency resonance, but the major portion of the needle scratch.

The arrangement is very simple, and is illustrated in Fig. 4; apart from the usual volume control potentiometer, the only components needed are a choke, a con-

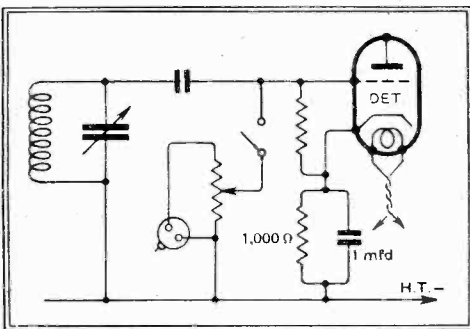

Fig. 3.—The connections for automatic bias in a mains set are shown here. The resistance in the cathode lead can be 1,000 ohms, and a 1 mfd. shunt condenser is sufficient.

denser, a fixed resistance, and a variable resistance. For a high-resistance pick-up,

¹ "Pick-up Resonance and Needle Scratch," by A. W. Stewart, *The Wireless World*, Dec. 16th, 1932.

such as the Marconiphone, the fixed resistance can have a value of 25,000 ohms and the variable resistance a maximum value of some 100,000 ohms. The condenser C should, theoretically, be variable, so that the circuit may be tuned to the exact resonance frequency of the pick-up, but in many practical cases it is sufficient to employ a fixed capacity of 0.001 mfd. The choke L should have an inductance of 2H., and a suitable component would be the Varley 3H. tapped choke.

The variable resistance should be adjusted to the point at which needle scratch practically vanishes, and the tone of the reproduction will then be appreciably lowered, due to the removal of the resonance. There should be no evidence that really high frequencies are missing, how-

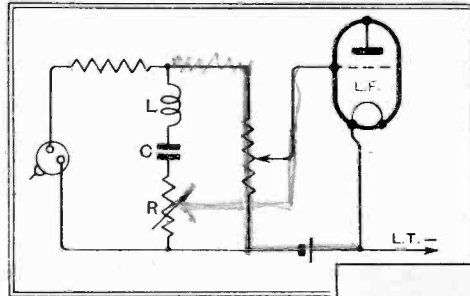
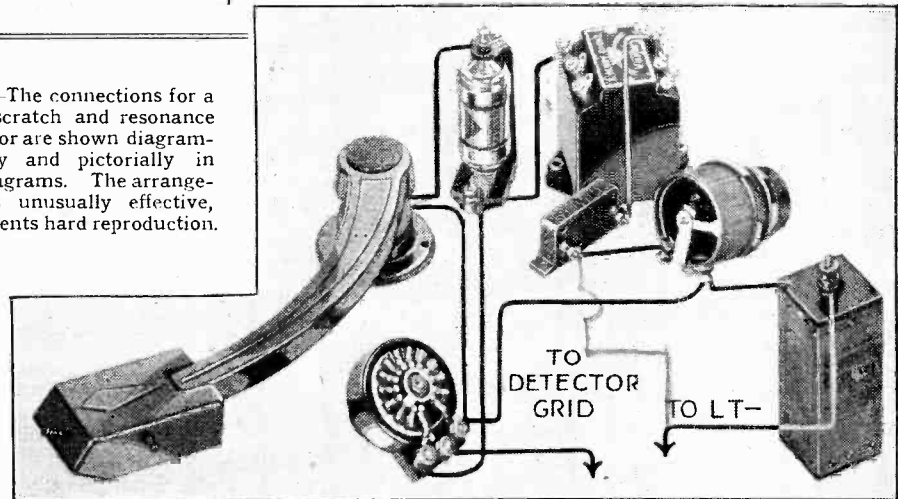

Fig. 4.—The connections for a simple scratch and resonance eliminator are shown diagrammatically and pictorially in these diagrams. The arrangement is unusually effective, and prevents hard reproduction.



ever. The values given above are, of course, suitable only for a high-impedance pick-up, and if a low-impedance type, such as the B.T.H., be employed, it is suggested that the fixed resistance be given a value of 2,500 ohms and that the variable resistance have a maximum value of some 20,000 ohms only. The choke inductance should also be reduced, and about 0.5H., with a capacity of 0.004 mfd., would probably be satisfactory.

By the careful application of this principle a vast improvement to the reproduction can often be made. It will be realised, however, that much depends on the pick-up, and the closer this approximates to perfection the smaller will be the improvement found on fitting the circuit.

The question of a suitable choice of needle is another factor of considerable importance. If an automatic record changer be used there is really no alternative to the Tungstyle type, and, in general, a loud-tone steel or Tungstyle needle will be found the best from the point of view of quality. Where trouble from pick-up chatter is present, however,

a half-tone steel needle may prove the best. Fibre needles should never be employed in ordinary circumstances, since most types are incapable of reproducing the really high frequencies, and they wear so rapidly that the quality at the end of a record is noticeably poorer than at the commencement. Where the high-frequency response is excessive, of course, fibre needles may, by virtue of their high-frequency attenuation, give an improved result; the correct course, however, is to redesign the apparatus so that a steel needle gives the correct reproduction.

CLUB NEWS

Making Moving-coil Loud Speakers

MR. R. E. FABIAN, late "Phyvenno," of the *Newcastle Evening World*, recently gave an interesting lecture-demonstration before the Newcastle Radio Society on the construction of a moving-coil speaker. Mr. Fabian was representing his firm, Whiteley Electrical Radio Co., Ltd. We understand that he would be pleased to give a lecture or demonstration to any Radio Society. His address is 5, Egremont Drive, Sheriff Hill, Gateshead.

The Hon. Secretary of the Newcastle Radio

Society is Mr. W. Pope, 9, Kimberley Gardens, Jesmond, Newcastle-on-Tyne.

Mains Transformers

AT a recent meeting of the Catford and District Radio and Television Society Mr. F. G. Sawyer, of Messrs. Partridge, Wilson and Co., lectured on "Mains Transformers and Power Smoothing Chokes." Demonstrations and a lantern slide display added much interest.

Hon. Secretary: Mr. H. W. Floyd, 38, Como Road, Forest Hill, London, S.E. 23.

Coming Shortly

A HIGHLY attractive programme will fill the spring session of the Southall Radio Society. Coming items include demonstrations of cathode ray, short-wave sets, television and loud speakers. On February 21st members will debate "That pentode valves have more favourable characteristics than a triode for modern set design."

Hon. Secretary: Mr. H. C. Rayner, 114, North Road, Southall.

For Battersea Amateurs

MR. F. G. SAWYER, of Messrs. Partridge, Wilson and Company, recently lectured on "Mains Transformers and Power Chokes" to the Battersea and District Wireless Society.

Full particulars of the Society can be obtained from the Hon. Secretary, Mr. S. F. Harris (G5SH), 93, Salcott Road, Battersea, London, S.W. 11.

The Radio-gramophone of To-day

The Variety of Types of Instrument



GRADUALLY, reproduction from records has come to be regarded as almost essential as a companion to broadcast reception, and practically every receiver of to-day has provision for the connection of an electrical pick-up. Apart from the instrument specially designed as a combination of gramophone and radio, there are a variety of units available for converting the broadcast set into a combination instrument.

THE name "radio-gramophone" is usually applied only to a completely self-contained installation embracing radio receiver, loud speaker, turntable, and pick-up, but it can, with equal justification, signify a wireless receiver used in conjunction with a "playing-desk," of which quite a number have made their appearance on the market in the past few months. Although the playing-desk is regarded by most people as something quite new, it is actually far older than the complete radio-gramophone; in fact, it might almost claim to be older than the broadcast receiver itself, since a well-known firm marketed one in 1921, over a year before the commencement of regular broadcasting.

The Playing Desk

As it preceded electrical recording by four years, it is rather difficult to see what was its *raison d'être*, for, although it was used with a low-frequency amplifier, the quality was certainly no better than that of the acoustic gramophone.

No real interest in the electrical reproduction of records was evinced, however, until some time later, after several different types and makes of pick-up had made their appearance. A playing-desk represented the first design put forward by *The Wireless World* in the direction of a radio-gramophone, full constructional details of such a device being given in 1927; it is interesting to note, however, that it was not until four years later, in 1931, that commercial firms saw the possibilities of a gramophone unit and pick-up as an accessory for increasing the enjoyment to be obtained from existing wireless receivers.

The simplest form of the radio-gramophone to-day is that in which a pick-up

is attached mechanically to the tone arm of an ordinary acoustic gramophone and electrically to the pick-up terminals of an existing receiver. Practically all wireless receivers of to-day are fitted with pick-up terminals, and so anybody who is

equipped for wireless and also possesses an ordinary gramophone, can convert his installation into a radio-gramophone at a cost of a pound or two—the price of a pick-up and volume control. Provided that the existing radio receiver is beyond reproach, there is not the slightest reason why the results obtained should not be equal to those obtainable from a completely self-contained instrument; indeed, as separate units the results may be better, unless the self-contained example has been carefully designed as a whole.

Needle-track Alignment

Admittedly, in certain cases the results will not be quite so good if the receiver is of the small and unduly compact type, for, despite efforts to prevent it, box resonance is often quite pronounced. This must not be taken as an adverse criticism of compact sets generally, for many of them are beyond reproach in the matter of quality of reproduction, whilst, on the other hand, certain console receivers leave quite a lot to be desired. As a general rule, however, one may expect better quality from a receiver that has less congestion at the back and sides of the loud speaker.

One or two important points must be remembered when purchasing a pick-up for use with an existing gramophone. In the less expensive of the mechanical gramophones no care is taken to obtain anything like correct needle-track alignment, yet this point must be attended to or various troubles will occur in electrical reproduction. The construction of cheap gramophones will not usually permit of the fixing of a new tone arm of more modern type, which would enable the gramophone to be used with an ordinary sound-box or pick-up as desired. It is usually necessary, therefore, to purchase a pick-up already attached to a proper carrier arm.

It is not worth while to buy a pick-up alone to add to an existing gramophone unless the gramophone is a really good instrument with a reliable motor and so built that needle-tracking is accurate. If the instrument falls short in these essentials it is far better to purchase a complete playing-desk. Most of these units are as small and compact as a portable gramophone.

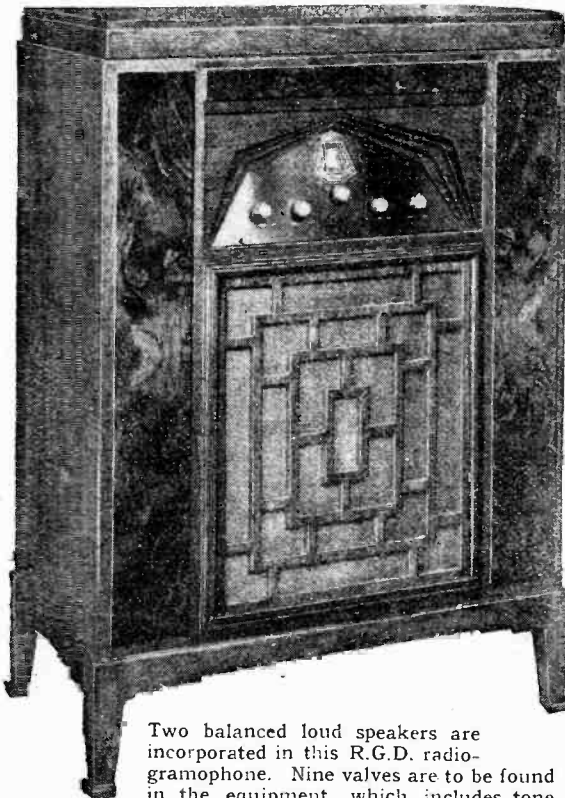

Two balanced loud speakers are incorporated in this R.G.D. radio-gramophone. Nine valves are to be found in the equipment, which includes tone control and a volume control effective on both radio and gramophone.

The Radio-gramophone of To-day—

phone, and they can, of course, be obtained with a spring or an electrically driven motor as required. They are very convenient, as they can be placed on a table or near an armchair, thus enabling the user to change records without constantly getting up; for this reason the playing-desk may be described as the poor man's record-changer.

These instruments can be obtained in various different types. In some the lid

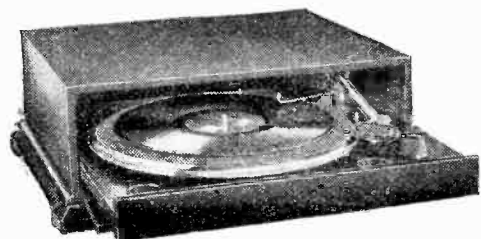

Ad-a-gram's radio-gramophone adaptor.

is hinged in the manner of an ordinary gramophone, whilst in others it is in the form of a pull-out drawer which can be pushed back into place as soon as the record is started in order to deaden the mechanical noise of the needle scratch.

It is advisable, of course, not to use extremely long pick-up leads, and the additional precaution of using screened leads is sometimes necessary. A great deal of nonsense is, however, talked about long pick-up leads by people whose knowledge is more theoretical than practical. In many cases where trouble is apparently caused by long leads the fault lies in bad receiver design. There is, in fact, nothing like a gramophone pick-up with leads of even moderate length for showing up inherent instability in a receiver.

Apart from the portable type of playing-desk just discussed, there is another form which, for want of a better name, may be described as a console model. It usually consists of a record-filing cabinet built in console form with the playing-desk at the top. The intention is that the existing radio receiver with its built-in loud speaker be placed on the top so that the whole installation forms a complete radio-gramophone. Usually in this type of instrument the playing-desk is in the form of an actual bureau with the usual let-down flap, the whole arrangement being very practical. Others, no less convenient, have a built-in drawer, as in the portable type previously discussed.

Many people prefer this type of instrument to a complete radio-gramophone of the more conventional type, since the loud speaker output is at ear level, or slightly above, which is certainly more correct theoretically than the low-down

position given by the ordinary instrument. In addition, ample space is given for record storage, which is not the case with the majority of instruments of the other type. This design of playing-desk can also be used with a console-type receiver, and the two pieces of apparatus would take up no more floor space than an ordinary radio-gramophone and its accompanying record cabinet.

Despite the merits of playing-desks, however, it cannot be seriously argued that the man who is starting *de novo* and has the necessary cash to spend on a radio-gramophone should purchase a receiver and playing-desk instead. The advantages of an instrument which has been specially designed for the function which it is intended to fulfil are too great to permit of their being outweighed by those of the playing-desk.

Considering the radio-gramophone from the gramophone side only, it must be remembered that the instrument can be purchased either with or without a record-changer. If the extra cost can be afforded a record-changer is a desirable adjunct, for the convenience is great in being able to select a complete programme and then retire to one's armchair with the knowledge that musical enjoyment can be had for half an hour or so without bothering to attend to the instrument. Practically all these automatic changing devices have an arrangement whereby the gramophone can be manually operated if required.

Incidentally, the joys of a record-changing device are not denied to the man who, possessing a good set, becomes a radio-gramophone owner *via* the playing-desk route; at least one firm markets a complete turntable, record-changing device, and pick-up, all mounted on a unit plate for fixing by screws into a playing-desk cabinet or other convenient article of furniture.

There is now only the radio side of the instrument to be considered. (It may be taken for granted that the power output of these instruments is adequate and their tone beyond reproach). The point to be decided is what radio range is required.

Two or three years ago practically all radio-gramophones, while excellent as electrical reproducers of gramophone

records, were woefully underpowered on the radio side and were suitable for the reception of nearby stations only. Nowadays one can purchase a radio-gramophone having any number of valves from two to ten, the multi-valve instruments embodying the superheterodyne principle and permitting the reception of practically any station having entertainment value. The choice of a radio-gramophone will be largely governed by the geographical position of the prospective purchaser, since this consideration will largely determine the degree of sensitivity and selectivity required.

Gramophone reproduction and wireless reception are now so closely associated in the minds of the public that it is almost amusing to recollect that when broadcasting began there was nearly a panic amongst record manufacturers lest broadcasting would eclipse their activities. Instead, we have seen interest in gramophone reproduction grow steadily side by side with the progress of broadcasting, and boom years in wireless and record sales have coincided.

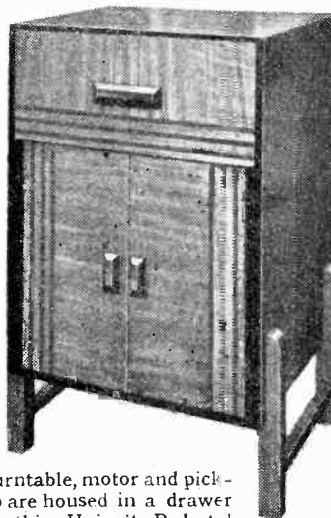

Turntable, motor and pick-up are housed in a drawer in this Univoit Pedestal Unit, where provision for storing records is provided in the lower compartment.

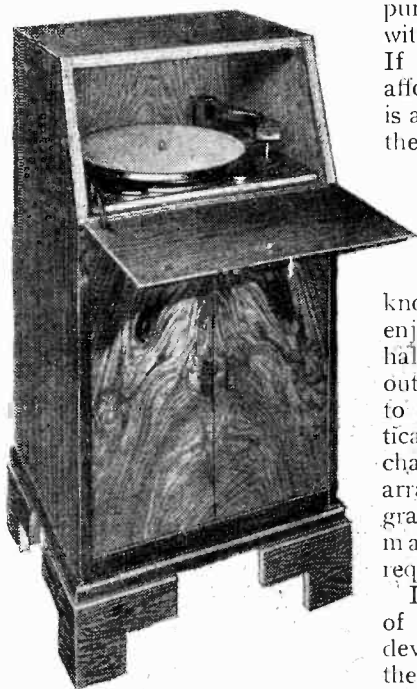

The "C.A.C." playing-desk incorporates an induction motor, pick-up and volume control.

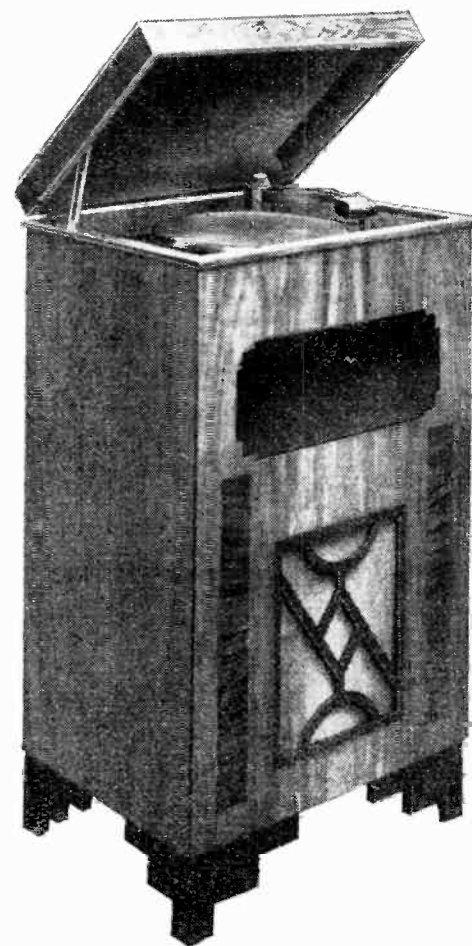

The Peto-Scott "Adaptagram" cabinet provides liberal space for a receiver or amplifier and loud speaker equipment. A spring or electric motor can be provided to drive the turntable.

UNBIASED

Following the Music

I SUPPOSE that most of you, like myself, find an added interest in listening to a broadcast opera or symphony concert by following the musical score. Personally, I find that my enjoyment of gramophone record recitals is similarly increased by following the "score," which is easily done by twirling the appropriate gramophone record round on a pencil and looking at it through an ordinary reading glass. It is a little trick taught me many years ago by an old musician who often plays an organ solo from a gramophone record by propping up a small portable gramophone on the music stand and allowing the record to rotate.

The ability to read the score of a record in this way—which is quite as easily acquired as reading an ordinary musical score if you will only persevere sufficiently—will, I assure you, greatly add to your interest in gramophone recitals. It has, at any rate, taught me to appreciate at its full value the strenuous efforts made by the B.B.C. to make good the well-known musical deficiencies of a gramophone record by superimposing sound



Quite easily done.

from instruments played in other studios. Sometimes their efforts are so emphatic that I find a real difficulty in following the original score on the record.

Bright Ideas for 1934

ALTHOUGH it is not yet six months since the last Olympia Show, it is by no means too soon to begin thinking about what we expect the manufacturers to provide for us in next season's models. If any of you have got any bright ideas in this respect, please send them along and I will endeavour to give them publicity. Only in this way can we get the manufacturers to market the things we want.

As a start off, I think that no manufacturer's range of sets should be included among the 1934 models which does not make provision for at least three wavebands, namely, long, medium, and the most useful of the various short wavebands. Of course, we must expect the

usual opposition. It will be pronounced technically impossible to produce such a set at an economic price, and the detrimental effects of switching will be pointed out to us; in short, the usual obstructionist methods will be employed, just as

By FREE GRID

they were umpteen years ago when we demanded dual-waveband receivers.

The use of automatic record changers on radiogramophones must become more widespread. Furthermore, there must not be so great a discrepancy between the price of a console receiver and a radiogramophone.

If any manufacturer knows of any just impediment to the achievement of these worthy aims let him declare it.

"Enormous Sacrifice"

IT is unfortunate, but none the less true, that obsolete sets and components are foisted on to the public as new, even in the radio departments of certain of the large stores. I came across a typical instance of this sort the other day in one of our large departmental establishments.

I noticed an imposing-looking superhet of 1926 vintage, the makers of which have long since passed along Carey Street to merciful oblivion. Evidently it had not been used, as it was very spick and span; and since its makers had been a firm always noted for their cabinet work it was of quite prepossessing appearance even when compared with the modern instruments which surrounded it.

Its original price—which would make a nasty dent in a hundred-pound note—was marked on it, followed by the words, "Maker's current list price." After this came the sale price of £10, which was hailed as an "enormous sacrifice."



Adding rhythm to records.

I don't know what you think about this sort of thing, but, in my opinion, it is sheer dishonesty, and I said so in no uncertain terms to the manager.

With Knobs On

I HAVE received a long and involved letter from a reader who sighs for the days that are no more. His particular moan is the paucity of knobs on the modern set. In the good old days, when men were men and sets were sets, he points out, you had at the very least half a dozen knobs to twiddle exclusive of filament rheostats. He goes on to lament what he calls the "effeminacy" of the average set-owner of to-day, who is not satisfied even with only one main tuning control on his receiver but wants still greater simplicity.

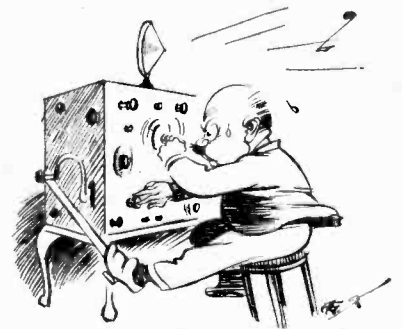

With treadle-driven generator.

Personally, I profoundly disagree with my correspondent, and would gladly welcome the present tendency towards simplification of control. Why use six tuning dials when one will suffice, and why use filament rheostats when they are not wanted? I am greatly in favour with the modern vogue of combining the on-off switch with the volume-control knob, and cannot for the life of me see why the wave-band and gramophone-switching arrangements should not be combined with the tuning knob, as is done in the case of a certain highly efficient receiver. This reduces the number of knobs to two only. Three knobs is, I think, the outside limit in numbers; if more are permitted we might be lavish and fit our sets with such refinements as a treadle-generator to supply H.T. and L.T.

Why not?

Her Tiny Hand is Frozen

MY confidential secretary complains that her fingers are stiff with cold and the tips thereof absolutely numbed as the result of typing these few notes, for in spite of the fact that the room is pleasantly warm the typewriter keys are like icicles. Surely it is not beyond the ingenuity of our manufacturers to turn out a model with electrically heated keys? The actual amount of heat per key that would be required would be infinitesimal, and a miniature heating element built into each key would be all that would be required.

NEWS of the WEEK

Current Events in Brief Review

Listening in Iceland

ICELAND'S listeners have increased in number by 28 per cent. during the past year. The Reykjavik transmitter now has a local audience of 5,418.

Welcome to Athlone!

BY the time these lines are read the new 80 kW. broadcasting station of the Irish Free State at Athlone should have opened its regular service. The station has been experimenting nightly after 10.30 o'clock on its wavelength of 413 metres.

Open-air Wireless Mart

FOR a daily "rent" of 50 centimes, the amateurs of Lyons are permitted to sell old radio sets and parts in the Place Riviere, Villeurbanne. Apparatus can be found here displayed on trestles or the cold cobble stones. The place is said to be a popular haunt for all radio-minded folk.

More Radio Palaces

APPARENTLY the best is just good enough for broadcasting, to judge from the general tendency to provide palatial headquarters for broadcasting purposes. Two new "Broadcasting Houses" are to go up in Germany: at Cologne and Königsberg respectively.

Rebuilding Giant Studio

EUROPE'S biggest broadcast studio, in Berlin, is to be completed. This imposing hall in the Funkhaus seats 750 people in the lower auditorium alone and contains room for many more in the gallery and orchestra. When the Funkhaus was first erected the large studio was given temporary walls and decorations while acoustic experiments were carried out.

Imported Valves

THE Board of Trade give notice that they have referred to the Standing Committee an application for an Order-in-Council to require the marking with an indication of origin of imported wireless valves and rectifying valves.

Those who desire to be heard in opposition at the public enquiry which will be held later should communicate with the Secretary, Mr. E. W. Reardon, at the Board of Trade Offices, Great George Street, London, S.W.1, not later than February 25th, 1933.

The Television Society

"THE New Gas Discharge Tubes and their application to Television" is the title of a lecture to be given before the Television Society on Wednesday next, February 8th, by Mr. Norman L. Harris, of the G.E.C. Research Laboratories. The meeting will be held at 7.0 p.m. at University College, Gower Street, W.C.1.

Non-members may obtain cards of invitation on application to the Hon. Business Secretary, Mr. J. J. Denton, A.M.I.E.E., 25, Lisburne Road, Hampstead, N.W.3.

Electing an Announcer

NEARLY 12,000 listeners in Algiers have taken part in the election of a lady announcer. The position has been won by Mlle. Costes, who originally officiated at the same station and, later, at *Poste Parisien*.

Another Swiss Regional

SWITZERLAND'S third regional station—that intended for the Italian-speaking population—is nearing completion in the centre of the fortified region of the Monte Ceneri, in the canton of Tessin, with studios at Lugano. The ceremonial opening will take place in the early summer.



THE COMPLETE POLICEMAN. The day draws near when every constable will be radio-equipped. (Above) A Brighton policeman with a motor cycle receiver. (Right) A Nottingham radio police car.

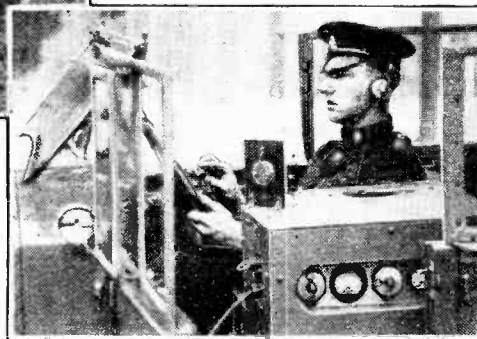

The Loudest Spot

LONDON may possess the world's noisiest city. Noise sleuths of the Western Electric Co. are now experimenting with their "sound meter" in various cities, filing the results at their Cricklewood Works, London.

The noisiest spot in London, according to last week's survey, was in Fleet Street, near *The Wireless World* offices, where the volume of sound measured 83 decibels. Lombard Street, in the financial quarter, and the Embankment were comparatively quiet, registering only 63 decibels.

In Switzerland

SWISS listeners numbered 231,000 on December 31st, 1932, an increase of 81,000 in twelve months.

Believe It or Not

OUR Paris correspondent reports that when, during the recent Anti-Interference Congress in the French capital, speakers were denouncing radio parasites in no uncertain terms, a local benefactor, misunderstanding the use of the term, sent an employée to the hall to distribute free packets of vermicide.

Tally Ho!

THE famous secret broadcasting station at Almelo, Holland, which sends out a nightly "good luck" message to the police who are trying to catch it, has not yet been run to earth. It is assumed that the station must be mobile, as no official direction finder seems to be able to locate it.

"Skip Distance" on 'Plane

STRINGENT requirements have been laid down in an order received by Messrs. Standard Telephones and Cables, Ltd., from the Belgian Air Force for fifty combined short-wave transmitters and receivers for use on Fairey "Firefly" fighting 'planes. The specification called for constant and reliable two-way telephonic communication on short waves, although the communicating machines and headquarters will often be only a few miles apart. "Skip distance" effect has had to be overcome, and this the company claims to have achieved.

Pigeons versus Wireless

IT may take the conceit out of radio engineers to learn that the Ontario Forest Patrol has decided not to depend entirely upon radio communication from its outlying posts. It is believed that under certain conditions pigeons will be far more efficient.

"The Accumulator"

A COURSE of six lectures on "The Accumulator" is to be given by Mr. R. W. Minter, A.I.E.E., on Wednesdays, at 6.30 p.m., at the Chelsea Polytechnic, Manresa Road, London, S.W.3, the first lecture being on February 15th next.

Full particulars can be obtained on application to the Principal.

Broadcasting via Light Beam

AN acid test for the photo-electric "eye" was carried out in New York on January 20th, when a woman singer's voice modulated a beam of light half a mile in length, extending from one New York skyscraper to another. The beam actuated a photo-electric cell which, in turn, modulated the broadcast carrier wave. The transmission was duplicated over the ordinary line, the engineers being able to switch from one to the other method without notifying listeners, who were unable to tell which method was being used at any given time.

Alternative Programmes in Japan

JAPANESE listeners are to enjoy alternative programmes in the near future, the Broadcasting Corporation of Japan having adopted a "regional" broadcasting plan on similar lines to that of the B.B.C.

New equipment for this purpose at the Osaka station consists of a Marconi Type P.A. broadcasting transmitter, of 10 kW. power, incorporating the most modern features of design, including the principle of low power modulation.

World's Oldest Broadcast Announcer?

HARRISON HOLLIWAY, manager of KFRC, San Francisco, claims to be the world's oldest broadcast announcer. Holliway built his own amateur station in 1919, and in November, 1920, at about the time that KDKA, the world's first regular broadcasting station, inaugurated its service, he began announcing over his station, 6BN. He is still broadcasting, and claims that no one preceded him who is still a regular announcer.

"The Wireless World" Index and Binding Cases

THE index for Volume XXXI, July to December, 1932, is now ready, and may be obtained from the publishers at Dorset House, Tudor Street, London, E.C.4, price 4d., post free, or binding case, 3s. 6d., post free.

Royal Warrant for H.M.V.

A FURTHER Royal honour has been bestowed on the Radio industry. The first Royal Warrant of the Prince of Wales for radio, records, and gramophones has been granted to The Gramophone Company, Ltd. Last month "His Master's Voice" were appointed official suppliers of radio apparatus to His Majesty the King.

Seen but Not Heard

STRASBOURG—the station "without a service area" might be an appropriate motto for the 11.5 kW. State broadcasting station in Alsace-Lorraine. According to a clamorous body of listeners Strasbourg cannot be heard even in the near neighbourhood of the transmitter owing to interference by foreigners.

MODERN PRACTICE IN PICK-UP DESIGN

Constructional Details Contributing to Quality of Reproduction and Convenience in Use

THE early development of the gramophone pick-up proceeded along empirical lines, and it was not until 1927 that an attempt was made to develop a design from first principles. In that year a paper was published in America by Kellogg which laid the foundation of modern practice and established the "half-rocker" moving iron pick-up as the predominant type.

In this design a small armature is pivoted between U-shaped pole pieces attached to a horse-shoe permanent magnet. The needle vibrations cause the magnetic flux to traverse the armature first in one direction and then in the other as the tip of the armature approaches first the North and then the South pole of the magnet. Surrounding the armature is a coil of fine wire in which the fluctuating magnetic field induces an electromotive force that is finally amplified and passed on to the loud speaker. Although individual makes show apparently wide divergencies in treatment it will be found on close examination that in most cases the basic half-rocker principle has been adopted, since it offers the best solution of the problem of combining the qualities required to do justice to records produced by modern methods.

The Ideal Pick-up

Briefly these qualities can be summarised as follows:—

- (1) Correct frequency response.
- (2) Freedom from harmonic distortion.
- (3) Freedom from record wear.
- (4) Adequate output.
- (5) Ease of needle changing.
- (6) Mechanical silence.

It will be assumed that this is the relative order of importance.

In dealing with the frequency response it goes without saying that the output should be free from sharp resonances. The earliest pick-ups suffered from a bad resonance in the middle register which was due to the fact that the armature was much too heavy. Consequently we find that the modern pick-up has the smallest possible armature, proportioned to give a low inertia. It has even been found possible to dispense with an armature as such, and to pass the magnetic flux through the needle itself. The Lissen needle armature pick-up is an example of this practice, which not only results in freedom from

In general principle the modern pick-up does not differ greatly from the first experimental models of five or six years ago. The "half-rocker" electromagnetic type still predominates, but its design is now established on a scientific basis, and closer attention is being paid to refinements, such as ease of needle changing, which contribute to the convenience of the user.

resonances but also gives a much improved response in the extreme upper register.

Judicious proportioning of the restor-

(Below) Lissen needle armature pick-up. The shoulder of the spear-point needle N, embedded in a rubber block B in the coil C, takes the weight of the pick-up head.

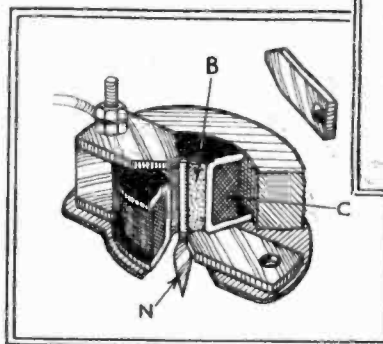

armature resonance being raised to a frequency of the order of 3,500 to 4,500 cycles. Even so this resonance must not be too pronounced, otherwise needle scratch may become prominent. Trouble from this source is far more frequently due to a high-frequency resonance than to a response which extends too high into the upper register.

Having safely disposed of the armature resonance, the next step in determining the frequency characteristic is to ensure

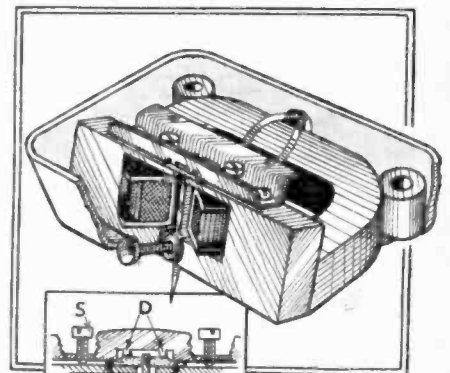

(Above) Adjustable damping in the Bowyer-Lowe Mark III pick-up. The rubber is clamped at C and the pressure of the damping contacts D is controlled by the set screws S.

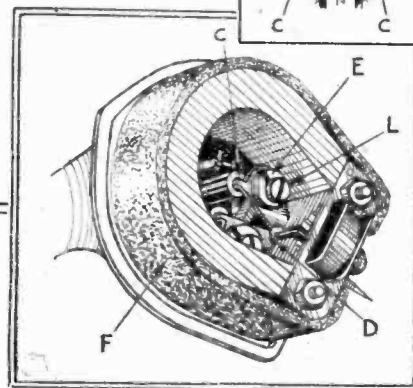

(Left) Accurate centring of the armature and damping block D in the British Radiophone pick-up is ensured by the pressure plates pivoted at C and adjusted by the cam E and locking screw L. Mechanical noise is reduced by the felt lining F.

pressure plates pivoted at C and adjusted by the cam E and locking screw L. Mechanical noise is reduced by the felt lining F.

that the output in the lower register below 250 cycles shall increase progressively to compensate for the restriction in amplitude necessitated by the limitations of the pitch of the record groove. The simplest method, and one which has been most

ing force due to the rubber damping pads holding the armature in a central position between the pole pieces results in the

Modern Practice in Pick-up Design—

frequently used in the past, is to obtain this increased output by narrowing the air gap, so that as the amplitude increases towards the bass the armature is brought closer to the pole pieces and a correspondingly increased magnetic flux is obtained. With this method a perfectly satisfactory response curve is obtained, but the effect of introducing amplitude distortion to obtain a rising characteristic in the bass also has the effect of causing modulation of high frequencies by low. In addition, harmonics are introduced, since the peak of the wave is drawn out as the armature approaches the pole pieces.

(Right) Side-play and the possibility of jarring is avoided in the hinged head of the B.T.H. de Luxe pick-up by adjustable sliding pivots P locked by grub screws G.

(Below) Leakage of magnetic flux is reduced and sensitivity increased in the Bulgin pick-up by assembling the laminated pole pieces L in echelon as shown at E.

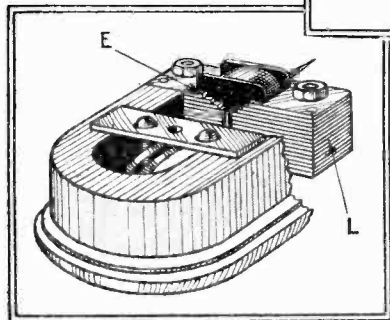
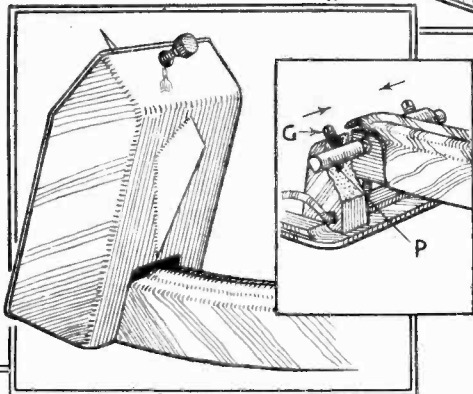

alignment. A weight of approximately 5 ozs. is generally accepted as giving the correct pressure at the needle point. If it is much lighter than this there is a tendency for the needle to jump the groove

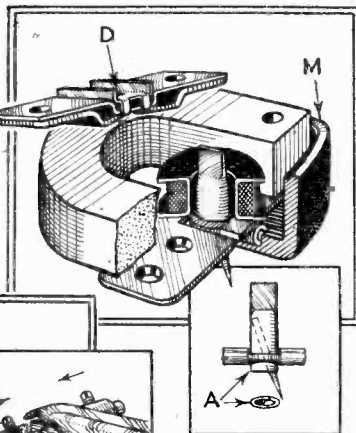

(Above) Section of the Limit "Reliance" pick-up. The case M is specially moulded to locate the armature pivot while the top pole pieces and damping clamp D are assembled as an integral unit. The oval section of the hollow armature needle carrier is shown at A.

during loud passages, while a heavier pressure may tend to abrade the surface of the record. Needle track alignment has been carefully studied, and it has been found that the simple expedient of setting the pick-up head at a predetermined angle to the tone arm axis gives correct tangential needle alignment within 1 or 2 per cent. at any point of the record. Sensitivity is important. In general an average output

simplified the task of the designer. High permeability nickel-iron alloys are also being used for the armature in many modern designs with promising results, while conservation of the permanent magnet flux by reducing leakage also helps greatly in obtaining increased efficiency.

The foregoing covers most of the essential factors governing the design from the electrical standpoint. There are, however, numerous opportunities for introducing refinements which contribute to the convenience of the user. Where a swivelling head is provided to facilitate needle changing it is important that the joint should be free from rattle. The time required to change a needle is greatly reduced in the Limit "Reliance" pick-up. No grab screw is provided and the needle is wedged diagonally in the hollow armature which is of elliptical cross-section. Experience shows that this method is entirely satisfactory, and that the weight of the pick-up head is sufficient to prevent the needle turning during the playing of a record.

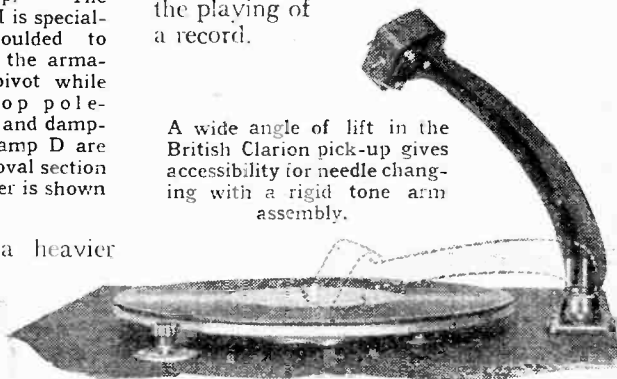

A wide angle of lift in the British Clarion pick-up gives accessibility for needle changing with a rigid tone arm assembly.

Consequently, we find that in modern designs tone-arm resonance is rapidly displacing amplitude distortion as a means of boosting the low frequencies. The flexibility of the needle and armature assembly and the effective mass of the tone arm are so proportioned that the tone arm resonates about the needle point at some frequency in the neighbourhood of 50 cycles. When tone arm resonance is employed the air gap can be increased, since the rising characteristic is obtained by mechanical and not electrical means.

The methods employed in obtaining the correct frequency response and freedom from harmonic distortion must not, however, prejudice the performance of the pick-up from the point of view of record wear. This is primarily a matter of reducing the stiffness of the armature movement in relation to the mass of the pick-up head and tone arm, and the performance from the point of view of record wear can generally be judged by the freedom of movement of the needle when gently rocked between the fingers. Other factors affecting record wear are the pressure at the needle point and correct needle track

Freedom from extraneous induction from the gramophone motor is given attention in most modern designs. If the tone arm is of metal this is generally earthed, a separate terminal being provided for the purpose. Finally, there is the question of mechanical silence. It is not an unusual experience to find that where a pick-up is used on an open turntable, the noise emitted by the pick-up—particularly at high frequen-

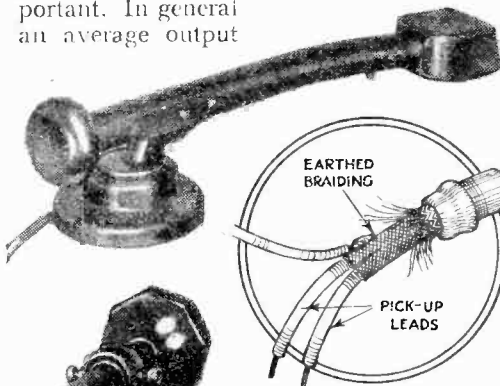

(Above) Screened leads in the Marconiphone pick-up prevent induction interference from the gramophone motor.

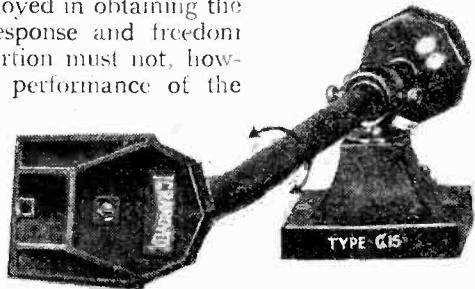

(Left) To facilitate needle changing the tone arm in the Igranic pick-up rotates as a whole.

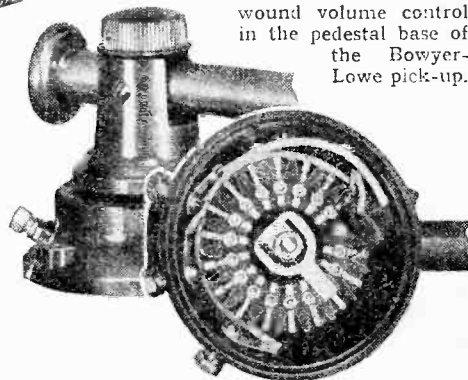

Self-contained wire-wound volume control in the pedestal base of the Bowyer-Lowe pick-up.

between 0.5 and 1 volt R.M.S. may be regarded as satisfactory. To maintain this output while keeping the air gap wide to reduce harmonic distortion is not always an easy matter, but improvements in magnet steels have greatly

exceeds that reproduced from the loud speaker. This trouble is overcome by cushioning the pick-up movement inside the head by rubber or felt lining.

In conclusion, it can safely be said that the design of the modern pick-up has kept pace with recording and amplifying technique.

Amplifier Designs—

volts, and thereby avoiding constant checking of the matching of the two output valves. This is achieved in the first place by adjustment of the auxiliary grid voltage, of which more anon. It requires, however, that each pentode auxiliary grid must have a separate H.T. lead so that a six-way battery cable is necessary to convey the various H.T. and L.T. voltages to their respective points. In addition, three other leads are brought out from the amplifier. These join to the loud speaker *via* the special Q.P.P. transformer, such as that fitted to the Celestion P.P.M.19 model moving-coil loud speaker, which, incidentally, was used during the initial tests of the amplifier. This has three terminals marked P1, P2, and H.T. + respectively, and on the diagram and wiring plan the leads that join to these terminals are marked accordingly.

The only other matter in connection with the wiring that needs attention is in connection with the filament circuit. The valve holders must be wired so that the pin

exceed 2 mA. It need not be a high-grade instrument, and one of the moving-iron type will serve. At this stage it might be as well to check over again the connections to the grid batteries to ensure that these are correct. If arranged according

possible, then a slight adjustment can be made to the grid bias potentiometer and the process repeated.

This valve is then removed and the remaining pentode inserted in the other valve holder. The auxiliary grid voltage of this

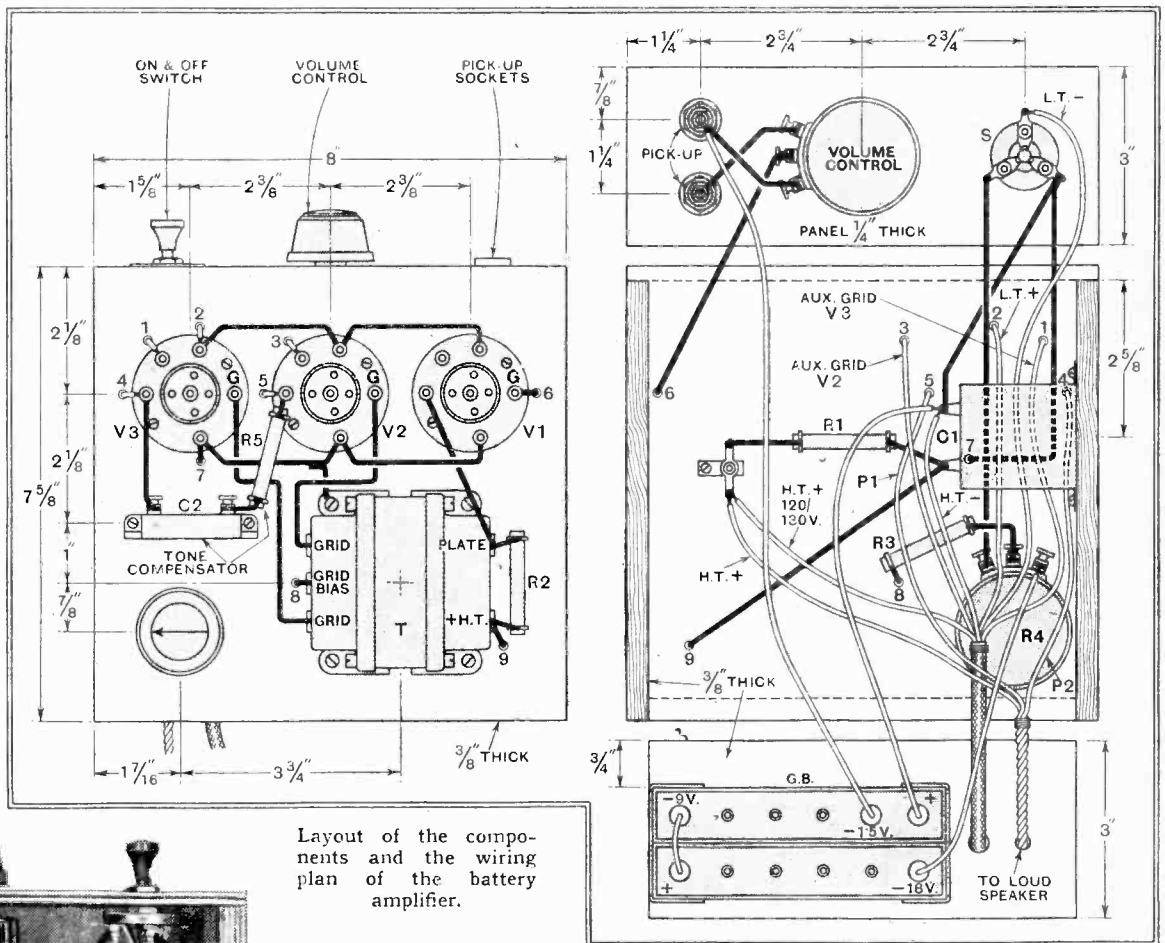

Layout of the components and the wiring plan of the battery amplifier.

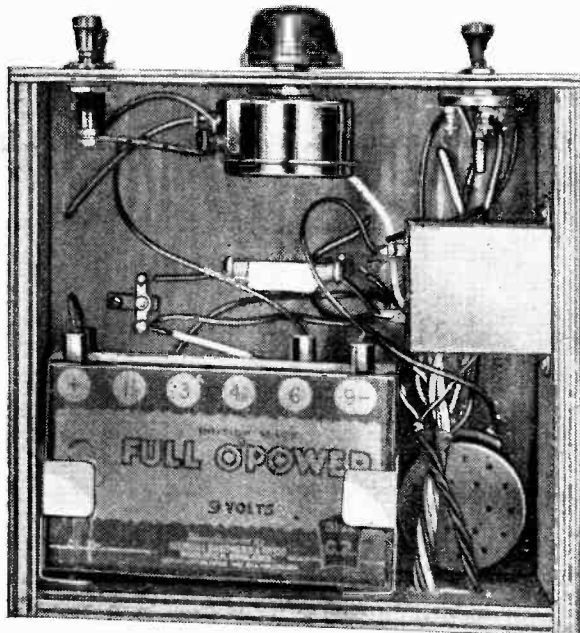

Underside view of the Q.P.P. amplifier showing the position of the grid batteries.

marked 3 on the base of the pentodes join to the negative of the L.T. battery.

Before the amplifier is put into use the two pentodes must be carefully matched. The process, however, is quite simple and entails nothing more than adjusting their respective auxiliary grid voltages so that the anode current is the same for each valve. A milliammeter taking 5 mA. for a full-scale deflection would be suitable for this purpose, as the current will not

to the drawings the output valves will receive the maximum bias, i.e., minus 18 volts, when the knob of the 25,000-ohm potentiometer is turned as far as it will go in a clock-wise direction. The working position is about one-sixth of a turn off maximum, but its actual setting is a matter for trial, as will be explained later.

One other item of the equipment that is non-standard is the H.T. battery. Owing to the fact that the pentode auxiliary grids require fairly critical adjustment of voltage a special Drydex battery has been evolved for use with sets and amplifiers embodying the Q.P.P. output stage. This is a 130½-volt unit of standard capacity size and it is provided with seven tapings at 1½-volt intervals from 120 volts onwards.

The milliammeter is connected in the main H.T. positive lead to the 130½-volt tapping, and one of the pentodes inserted in position. The auxiliary grid H.T. supply lead for this valve is then plugged into the various intermediate H.T. sockets in turn until a position is found that gives a reading of 2 mA. approximately on the anode milliammeter. Should this not be

valve is then adjusted so that the milliammeter reads the same as in the case of the other valve, but the grid bias voltage must not be altered. Should it be impossible to obtain a perfect balance then a slight readjustment may be made to the



Three-quarter plan view of battery model. In the lower right-hand corner is the control knob of the grid bias potentiometer.

grid bias potentiometer, but the important point to remember is that both valves be matched finally with the same bias.

Amplifier Designs—

When the valves have been matched the milliammeter must be removed from the H.T. supply lead when the remaining

sufficient to give a large power output under all conditions. The potential on the anode of the output valve will rarely exceed 160 volts or so, since from the

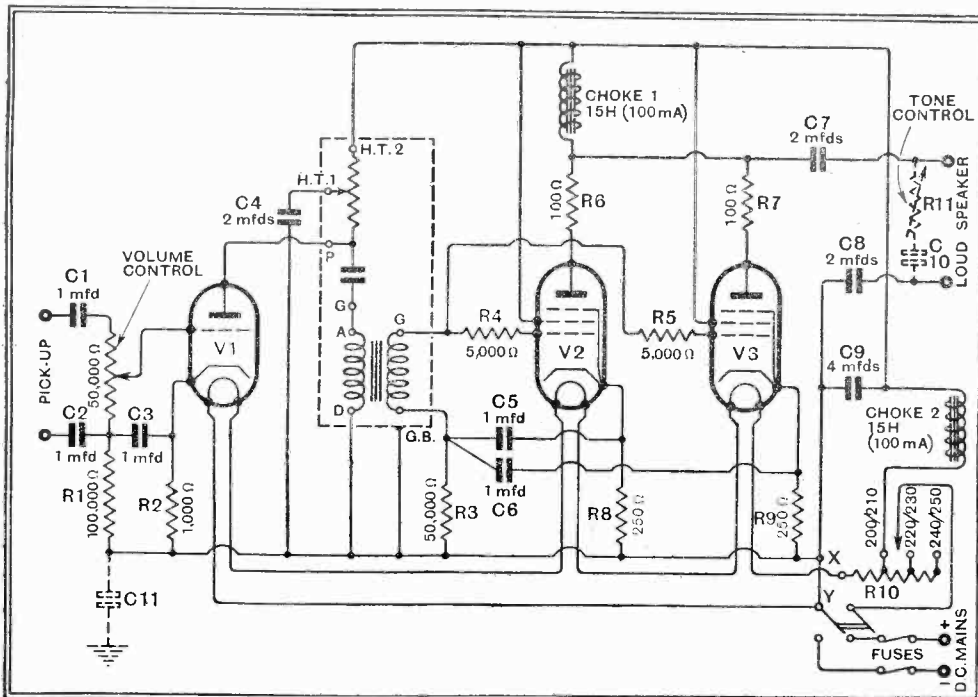

Circuit diagram of the D.C. mains amplifier. The components enclosed by a dotted line are contained in the R.I. coupling unit. Valves are, V1 Marconi or Osram D.H. V2 and V3 Marconi or Osram D.P.T.

valve can be placed in position and the amplifier given its first practical test.

D.C. Gramo-Amplifier

In view of the improved efficiency of the latest types of indirectly heated D.C. valves sufficient amplification can now be obtained with a two-stage amplifier, in which transformer coupling is used, to comply with all normal requirements. Furthermore, it has the distinct advantage that there is little likelihood of encountering L.F. instability and kindred troubles if the usual precautions are observed. Complete decoupling and such safeguards as the inclusion of anti-parasitic resistances in the grids and anode circuits of the two output valves are, nevertheless, essential to ensure absolute immunity from the troubles so often met with in amplifiers of this type.

The use of two pentodes in the output stage, with their grid and anode circuits joined in parallel is, admittedly, a refinement, but experiments have shown that one valve only is hardly

available D.C. supply has to be deducted the volts lost in smoothing, by grid bias and in the output choke, so that the valve is not working anywhere near its maximum efficiency.

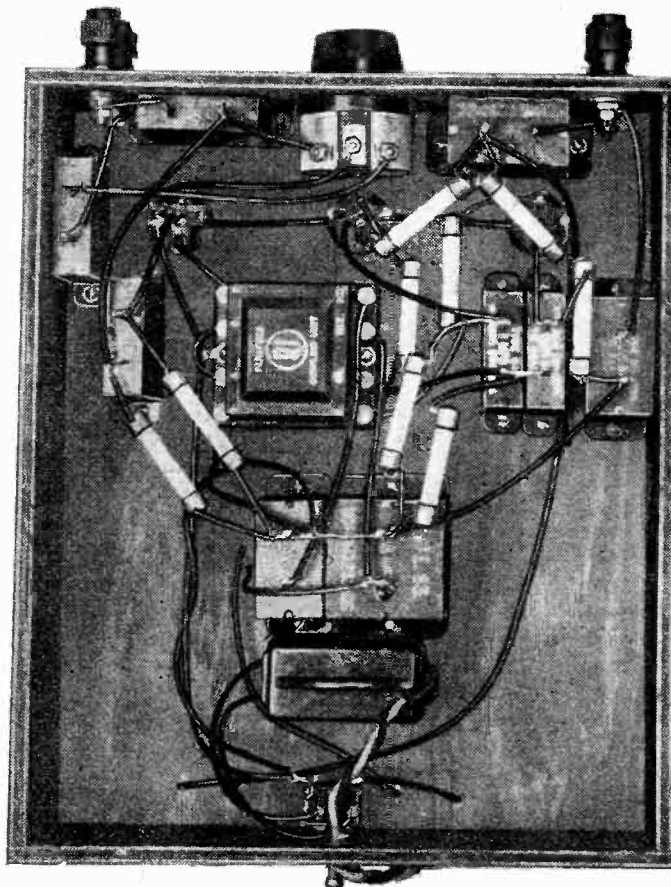

This view of the D.C. model shows the numerous small components accommodated below the baseboard.

It will be seen from the circuit diagram of this unit that particular care is taken to isolate completely the gramophone pick-up and the loud speaker from the supply mains; one-mfd. condensers suffice in the case of the pick-up circuit, but two-mfd. condensers are employed in the output circuit. If further protection is desired the unit can be fitted in a small cabinet, but it must be borne in mind that the valves dissipate a fair amount of heat, and adequate ventilation should be provided.

Although it has not been found necessary to earth the amplifier to suppress hum

LISTS OF PARTS.

After the particular make of component used in the original model, suitable alternative products are given in some instances.

Q.P.P. BATTERY AMPLIFIER

- 3 5-pin Valve holders **W.B. type "A.C."**
(Benjamin, Ferranti, Junit, Lotus, Wearite)
- 1 Push-pull L.F. transformer, 1:7 **Ferranti AF60**
(Multitone 1:9 ratio, R.I. model DY34, Sound Sales 1:9 ratio, Varley)
- 1 Resistance, 10,000 ohms, 1 watt, **R5** **Erie**
- 1 Resistance, 20,000 ohms, 1 watt, **R1** **Erie**
- 1 Resistance, 50,000 ohms, 1 watt, **R2** **Erie**
- 1 Resistance, 150,000 ohms, 1 watt, **R3** **Erie**
(Dubilier, Claude Lyons)
- 1 Fixed condenser, 0.01 mfd. mica, **C2** **Graham Farish**
(Dubilier, T.C.C., Telsen)
- 1 Fixed condenser, 2 mfd., 700 v. D.C. test, **C1** **Wego**
- 1 Volume control, 25,000 ohms, **R4** **Igranic No. 2235/7**
- 1 Volume control, 50,000 ohms **Igranic No. 2235/8**
(Colvern, Lewcos, Rotorohm, Varley, Watmel, Wearite)
- 1 3-point Switch **Goltone R26/745**
(Junit, Telsen, W.B.)
- 2 Grid bias batteries, 9 volt
- 1 pair Grid bias battery clips **Bulgin No. 7**
- 2 Insulated terminals **Clix "All-in"**
(Belling-Lee, Burton, Eelex, Igranic)
- 1 6-way Battery cable, 30in. **Goltone "Court" R40/16**
(Belling-Lee, Bulgin, Harbros, Lewcos)
- 5 Wander plugs **Clix "Master" type "B"**
(Belling-Lee, Eelex)
- Wood, Systoflex, small quantity 20 tinned copper wire, etc. Wood baseboard, 7½ x 8 x ¾in.
- Screws: 5 ¼in. No. 4 R/hd.; 4 ¼in. No. 6 R/hd.; 6 ¼in. No. 4 R/hd.; 5 ¼in. No. 4 C/sk.
- Valves: 2 Mazda Pen 220A, 1 Cossor 210 HF, or Mazda HL210, or Marconi HL2 or Osram HL2, or Mullard PM1HL.

D.C. GRAMO-AMPLIFIER

- 3 5-pin Valve holders, chassis mounting type **Bulgin VH7**
(Clix, Eldystone, W.B.)
- 2 Chokes, 15 henrys, 100 milliamps **Bulgin LF21**
(Ferranti B1, Igranic C80, R.I. 28/14 henrys)
- 1 Mains resistance, **R10** **Bulgin MR5**
- 1 Volume control, 50,000 ohms **Colvern type ST10**
(Igranic, Lewcos, Rotorohm, Varley, Watmel, Wearite)
- 5 Fixed condensers, 1 mfd., **C1, C2, C3, C5, C6,**
250 v. D.C. working **T.C.C. type 65**
- 3 Fixed condensers, 2 mfd., **C4, C7, C8,** 250 v.
D.C. working **T.C.C. type 65**
- 1 Fixed condenser, 4 mfd., **C9,** 250 v. D.C. working
(Dubilier type BB, Goltone, Wego) **T.C.C. type 65**
- 1 L.F. coupling unit **R.I. "Parateed"**
(Bulgin "Transcoupler")
- 1 2-pole mains switch **Bulgin S88**
(Claude Lyons)
- 2 Metallised resistances, 100 ohms, **R6, R7,** 1 watt **Dubilier**
- 2 Metallised resistances, 250 ohms, **R8, R9,** 1 watt **Dubilier**
- 1 Metallised resistance, 1,000 ohms, **R2,** 1 watt **Dubilier**
- 2 Metallised resistances, 5,000 ohms, **R4, R5,** 1 watt **Dubilier**
- 1 Metallised resistance, 50,000 ohms, **R3,** 1 watt **Dubilier**
- 1 Metallised resistance, 100,000 ohms, **R1,** 1 watt **Dubilier**
(Erie, Claude Lyons)
- 1 Twin safety fuseholder with 1 amp. fuses **Bulgin F11**
(Bulgin F11) **Belling-Lee No. 1033**
- 4 Ebonite shrouded terminals **Belling-Lee type "B"**
(Burton, Clix, Eelex, Igranic)
- 1 Adaptor **Goltone R80/90**
- Wood, Systoflex, small quantity 20 tinned copper wire, flex, etc. Wood baseboard, 11½ x 9½ x ¾in.
- Screws: 26 ¼in. No. 4 R/hd.; 10 ¼in. No. 4 R/hd.; 2 ¼in. No. 4 R/hd.
- Valves: 1 DH, 2 DPT **Marconi**
(Osram)

Amplifier Designs—

there is the possibility that on certain supply systems this might be desirable, in which case the earth connection should be made *via* a one- or two-mfd. condenser, and can be arranged as shown by the dotted lines in the circuit diagram. Under no condition should the amplifier be earthed direct.

The position of the smoothing choke Ch2 is based on the assumption that the negative conductor of the supply main is at earth potential, but this will not necessarily be so in every case.

Now the smoothing choke must be connected in the "live" main to be effective, but it is not proposed here to suggest that the constructor should test his mains to ascertain which conductor is earthed. The easiest and simplest way is to assemble the amplifier as shown, and if mains hum is at all pronounced to change over the smoothing choke to the other line and insert it between the points marked X and Y.

Volume is controlled by a potentiometer in the grid circuit of the first valve, and although one of 50,000 ohms has been fitted, its value really depends on the type of pick-up employed, as explained in the

Specimen equipments are available for inspection at 116-117, Fleet Street, London, E.C.4.

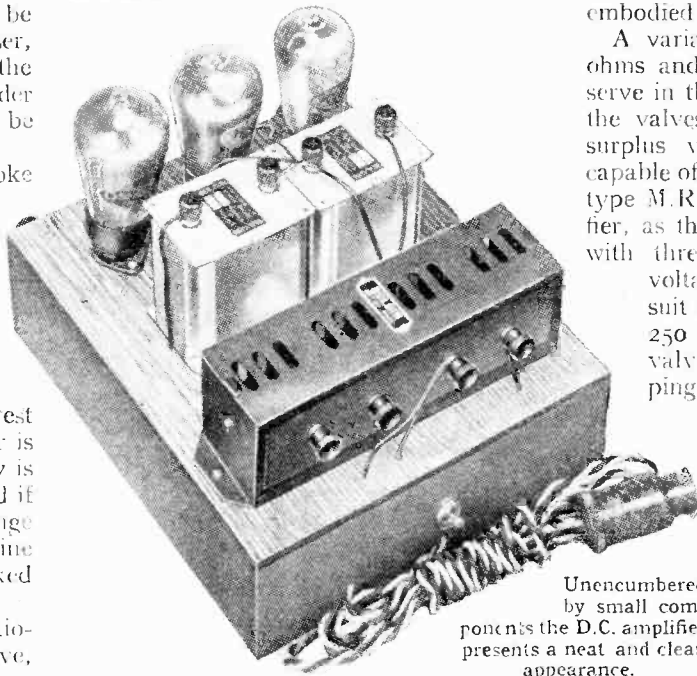

Unencumbered by small components the D.C. amplifier presents a neat and clean appearance.

but if one is deemed necessary it can be joined across the output terminals as shown in dotted lines in the diagram, or embodied in the loud speaker.

A variable resistance of about 25,000 ohms and a 0.05 mfd. condenser would serve in the present case. The heaters of the valves are joined in series, and the surplus volts dropped by a resistance capable of carrying 0.25 amp. The Bulgin type M.R.5 is used in the present amplifier, as this model is intended to be used with three valves only. It has three voltage adjusting tappings and will suit all supply mains between 200 to 250 volts. The H.T. supply for the valves is taken from the 200-volt tapping. Separate grid bias resistances are fitted in the cathode lead of each valve, which, so far as the output stage is concerned, ensures that in the event of one valve failing the other will not be damaged and will receive adequate bias.

The constructional work should not present any difficulties, as it entails little building a box-type base, assembling the components, and wiring.

earlier part of this article. No provision more than is made in the design for a tone control,

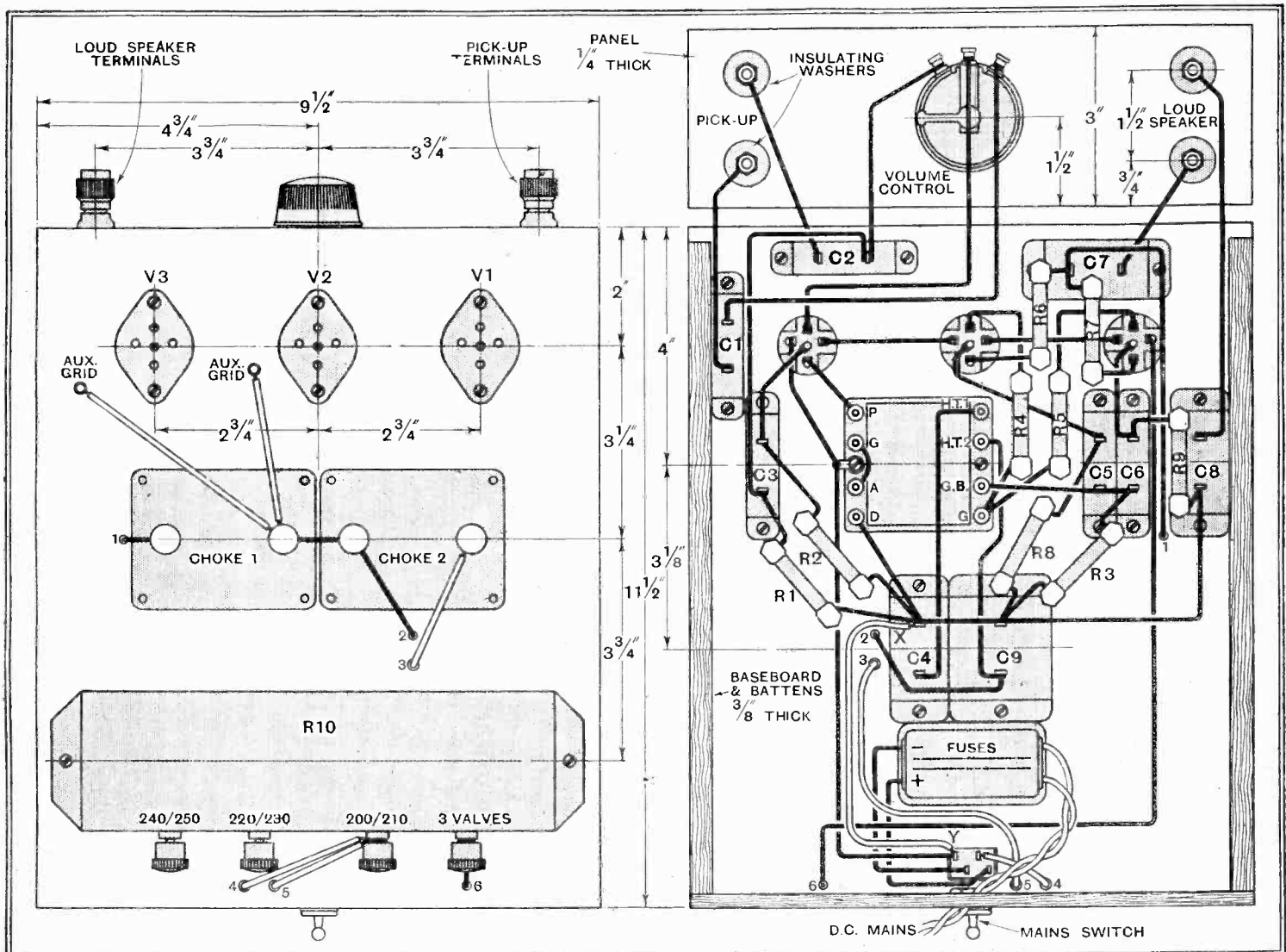

Disposition of the components and wiring diagram of the D.C. amplifier. The mains voltage adjustment lead passes through the hole identified by the numeral four.

Amplifier Designs—

The pick-up and the loud speaker should be well insulated from the wood, either by fitting ebonite washers on each side and drilling large clearance holes in the panel for the metal shanks, or by employing completely insulated models, as in the case of the battery amplifier.

The R.I. Parafeed Coupling Unit may be connected in a number of different ways, but the one adopted here, and shown in the wiring plan, is the best for our purpose, since it joins the sundry component parts inside the case to give a straightforward parallel-fed transformer having a 1 to 3 step-up ratio. Alternative connections affording a higher ratio and making use of the auto-transformer coupling are not advised, since they vitiate the grid decoupling of the output stage as arranged at present.

Anode Decoupling

One section of the resistance in the R.I. Unit is employed to decouple the anode circuit of the first valve, and a two-mfd. condenser is joined between the H.T.1 terminal and the negative line. This capacity will suffice, as a rule, but it is just possible that if the D.H. valve used is slightly above the average in efficiency an additional two-mfd. condenser in parallel with C₄ may be necessary to decouple this stage completely.

To avoid confusion in following the wiring diagram it was decided to omit all the "earthing" wires joining the metal cases of the various condensers to the negative line. This must be done, and the most convenient way is to remove the paint from one fixing lug on each condenser and loop a wire under the head of the fixing screw and join it to the nearest point on the negative line.

The majority of loud speakers include an input transformer, and it is customary to provide a few tappings so that the correct matching between speaker and output stage can be ensured. The two pentodes will give the best results when working into a 4,000-ohm load, but it will not be necessary to obtain a special transformer as this falls within the latitude allowed on the standard models.

AN A.C. POWER AMPLIFIER

Constructional details of a 25-watt gramophone amplifier for A.C. mains, built as a self-contained unit with electric motor and pick-up, will be given in the issue dated February 17th.

CORRESPONDENCE**American Broadcast Reception**

I AM extremely interested in the experiences of "Experimental Station G6LI" as set forth in your Correspondence columns.

I beg to endorse their statements and desire to associate myself with the sentiments expressed, in connection with "medium-wave" transatlantic reception.

Conditions permitting, my average nightly "bag" is thirty New World stations, 25 per

cent. of which are of definite entertainment value after 3 a.m. K.P.O. (California), on approximately 442 metres, is very erratic even on the best of mornings, although, at times, it comes in with great strength. South American stations are strong and consistent just now, but broadcast very little of general interest.

I am fully in accordance with the view expressed regarding the superiority of a well-designed and *correctly ganged* "super-het." I should like to mention, for the benefit of other radio enthusiasts, that it is absolutely unnecessary to possess L.F. power valves dissipating enough watts to run a small power-station in order to receive transatlantic stations.

I also desire to express my curiosity regarding the future problem of station separation. Even now several European stations are subject to "American" interference, quite early in the evening.

In conclusion, I wish to register a protest at the serious morse interference on the "broadcast bands." Having kept a lengthy record of the ships and land stations concerned, I definitely attribute most of the interference to land stations; and therefore consider that it is up to the B.B.C., in-

identally the Post Office, who collect our "ten bobs" to give the matter their earnest consideration.

"ZETA."

Liverpool.

Electrical Interference

"Free Grid's" remarks in the January 13th issue of *The Wireless World* with reference to the trolley-bus nuisance have interested us. Without exaggeration, it can be safely said that the present state of affairs has lost us the sale of hundreds of radio receivers. This you must admit can be taken as a very good indication with regard to the extent of the trouble. Although we have large show-rooms, it is quite impossible to demonstrate a set, just because our premises are situated on the trolley-bus route.

Naturally, the local W.R.A. has taken the matter up with the P.O. and Corporation officials and meetings were arranged. The outcome of the situation was a deadlock. The Corporation were not prepared to finance anything; furthermore, by their own report, there was no apparatus that would effectively cut the disturbance out.

A. ADCOCK,

For the Ipswich Wireless Co., Ltd.

DISTANT RECEPTION NOTES

QUITE a number of new high-powered stations will shortly be conducting their initial tests within the limits of the medium waveband. At the recent Madrid Conference it was decided that on the medium waves power should be limited to 100 kilowatts, though 150 kilowatts might be used on the long waves. Certain exceptions, however, were made amongst existing and projected medium-wave stations. The new Berlin Witzleben transmitter, for instance, is designed for 120 kilowatts. It is anticipated that it will be in full operation by the beginning of the spring.

Vienna's new giant is nearing completion at Bisamberg, which, like Brookmans Park, is situated a dozen miles or so outside the city itself. This plant will also include a transmitter capable of 120 kilowatts when required. Tests are likely to begin in March or April and full working may be expected a few weeks later.

Forty Programmes for All?

Not to be outdone, the Hungarian authorities are erecting a 120-kilowatt transmitter near Budapest in addition to a system of relays which should enable the whole country to be covered.

Both of the Brussels stations will be up to 75 kilowatts this year, and Rennes will be transmitting with an output rating of at least 60 kilowatts. Other stations which will join the super-power class—most of them with ratings probably between 60 and 75 kW.—are Hamburg, Belgrade and Bucharest. The time is in fact not far distant when every available channel, with the exception of those devoted to common waves between 300 and 550 metres will be occupied by a station with a power rating of from 25 to 120 kilowatts. Provided that the selectivity of the receiving apparatus is adequate this should mean that listeners will have a choice of thirty or forty programmes within the limits of the medium waveband alone.

The only fly in the ointment is sideband splash, against which knife-edge selectivity is of no avail. It is to be hoped that at the forthcoming Prague Conference an agreement may be reached to limit strictly the permissible depth of modulation for speech transmissions, for the trouble is mainly caused by the use of very deep modulation or even over-modulation during such transmissions.

Best American Wavelengths

At the moment the reception of American stations is by no means so good as it was at the end of last year. There are, in fact, nights when hardly a whisper can be heard from transmitters on the other side of the Atlantic. These, though, are fortunately rare, and old friends such as WJSV, WCAU, WBZ, WHAM, WTIC, WENR and WPG seldom disappoint. Those who intend to burn the midnight oil will do well to remember that, as a general rule, the best stations are those with wavelengths between 200 and a little over 300 metres. If I were asked to select the most profitable of all parts of the waveband for American stations I would choose a belt a little above and below 270 metres.

Of European stations the best upon the long waves just now are unquestionably Zeesen and Radio-Paris. Warsaw is much less interfered with than it was by the Eiffel Tower and comes through as a rule with splendid quality and strength.

I would pick Katowice as one of the best medium-wave stations. It must, I am sure, be using more than its rated power output of 16 kilowatts. Listeners, though, may have some difficulty in receiving this station when Athlone comes into full service. Other stations that I can strongly recommend to the attention of listeners are Rome, Stockholm, Brussels No. 1, Munich, Budapest, the Poste Parisien, Leipzig, Frankfurt, Turin and Magyarovar.

D. EXER.

Types of GRAMOPHONE MOTOR

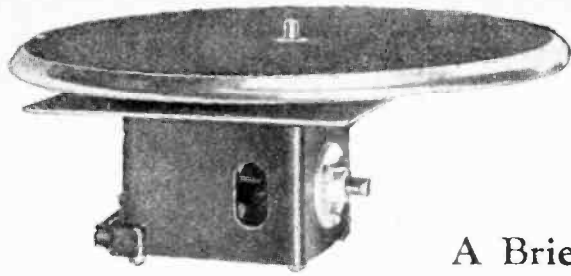

Harlie "Midget" high-speed induction motor.

A Brief Guide to the Salient Features of Modern Designs

THE electric gramophone motor has been developed to a high state of perfection, and it is safe to say that any of the leading makes can be bought with the assurance that the performance from the point of view of cool running, adequate torque, and reliability will leave nothing to be desired. There are, however, several distinct principles of operation in current use, and it may therefore be profitable briefly to run through the salient features of each type in order that a prospective purchaser may choose the one best suited to his individual requirements.

Where D.C. mains are available the choice is limited to the "universal" or commutator type of motor. This motor works either on A.C. or D.C. mains and is governor-controlled. It may be of the high-speed geared type or of the slow-speed type in which the rotor runs at turntable speed. The latter principle is conducive to long life and is specially suitable for continuous service in restaurants, dance halls, etc.

If alternating current supply mains are available the range of choice is wider. One of the most popular types is the induction motor, which depends for its action upon the setting up of eddy currents in a plain metal rotor. Here, again, we have both high- and low-speed types, the former em-

ploying a small geared motor with a cylindrical rotor and the latter a large-diameter disc running at turntable speed. With the eddy current principle of drive the speed would tend to increase indefinitely, so that governor control is necessary. This is an advantage where records requiring slight differences of speed for standard pitch are to be played.

In the synchronous motor we have the

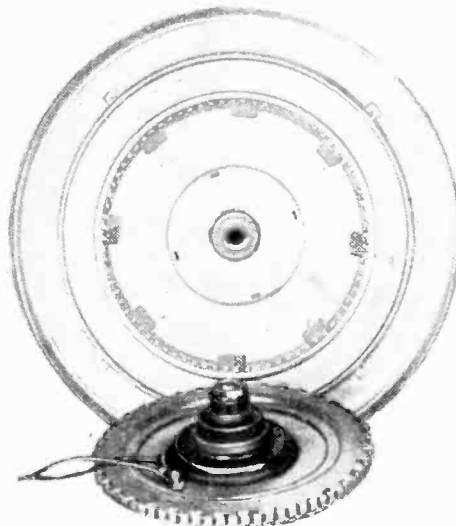

Simpson's electric turntable, a synchronous motor of exceptionally small depth.

chronous principles. On first switching on the current the motor functions on the induction principle and its speed increases until the correct turntable speed is reached, when the motor falls into step with the 50-

B.T.H. "Truspeed" motor, combining the advantages of induction and synchronous motors.

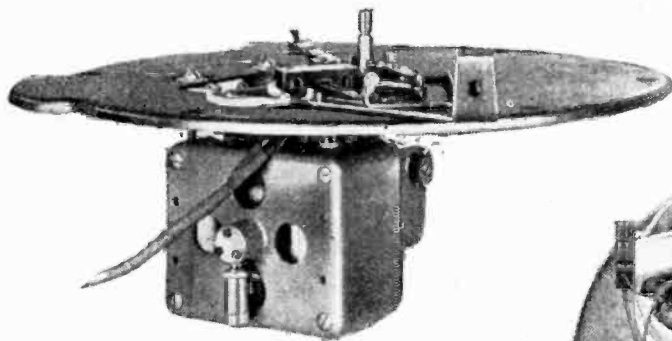
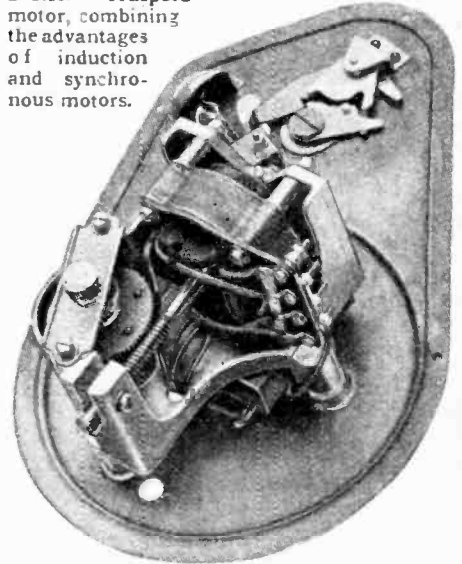

Collaro Model 32 high-speed induction motor.

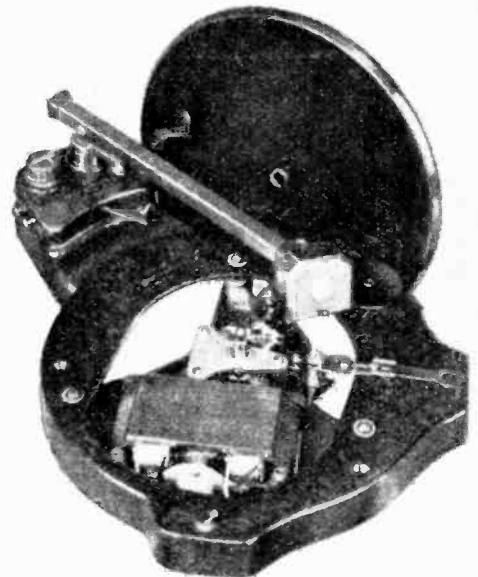

Univolt high-speed induction motor incorporated in a shallow playing unit with pick-up and volume control.

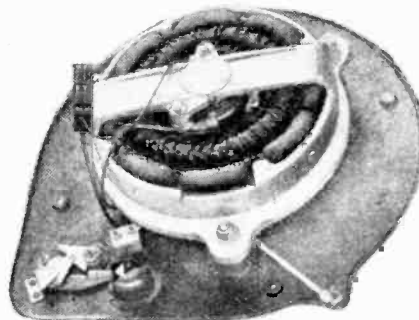

B.T.H. slow-speed "Universal" motor.

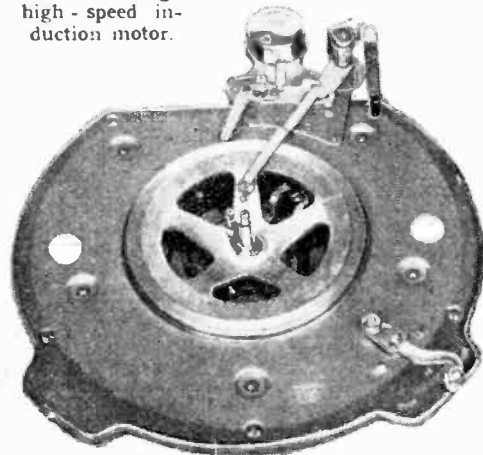

Garrard slow-speed induction motor.

simplest and cheapest type of A.C. motor. No governor is required, and the number of poles is fixed to give the standard turntable speed of 78 r.p.m. on a 50-cycle supply. It is necessary to start the turntable by hand, but the knack of hitting-off the synchronous speed is soon acquired. A shock-absorber is usually incorporated to smooth out any roughness due to the 50-cycle impulses.

The advantages of constant speed are also to be found in the self-starting synchronous A.C. motors which have recently made their appearance. The rotor is designed to operate both on the induction and syn-

cycles supply. The synchronous force is made sufficiently strong to hold the motor speed constant against the induction effort which would otherwise tend to make speed increase.

To sum up, the universal commutator motor is the only type suitable for D.C. mains and may still be used if the supply should subsequently be changed to alternating current. For A.C. mains the synchronous motor, whether in its simplest form for starting by hand or of the self-starting type, gives absolutely constant speed and avoids the complication of governor mechanism, while the induction motor offers the possibility of speed control for recordings designed to run at speeds other than 78 r.p.m.

Choosing a Record Changer

Important Details Affecting Smoothness of Operation



Record-changing mechanism fitted to current H.M.V. radio-gramophone.

OWING to the somewhat complicated work which a record-changing mechanism has to perform and to the fact, comparatively speaking, that it is yet only in the development stage, too much care cannot be taken in making a choice. It is the purpose of this article to consider some of the points which require attention.

First of all let us think of all that an "ideal" record changer should do and then go on to see how near the commercial instrument approaches it. Our "ideal" machine must be capable of taking at least eight records of any size and make, play both sides of each in succession and stop at the end. There must be no appreciable interval between the finish of one record and the start of the next, nor must the pick-up needle require any attention. Records not liked must be capable of instantaneous rejection at the pressure of a button and another button should permit a record to be repeated. The mechanism

THE automatic record changer has found such popularity as an adjunct to the radio-gramophone that it has become standardised in many of this season's more ambitious equipments. As it is a complicated piece of mechanism the finer points of construction should be studied before making a choice.

are now available, however, with consecutive parts on separate records so that the principal objection to this type of instrument has been met. Only one turnover of the pack of records is involved in the playing of a complete work.

In most types, the records to be played are stacked on a shelf or catch immediately above the turntable, on which the first record is placed. The pick-up plays this record and when it reaches the end is raised and carried outwards. The record at the bottom of the pile is then allowed to drop on to the top of that already on the turntable. An escapement mechanism prevents more than one record falling at a time.

The cycle of operations is repeated until all the records have been played, when either the last record will be repeated indefinitely or the motor will be switched off.

Most makes also include "repeat" and "reject" controls for earlier records.

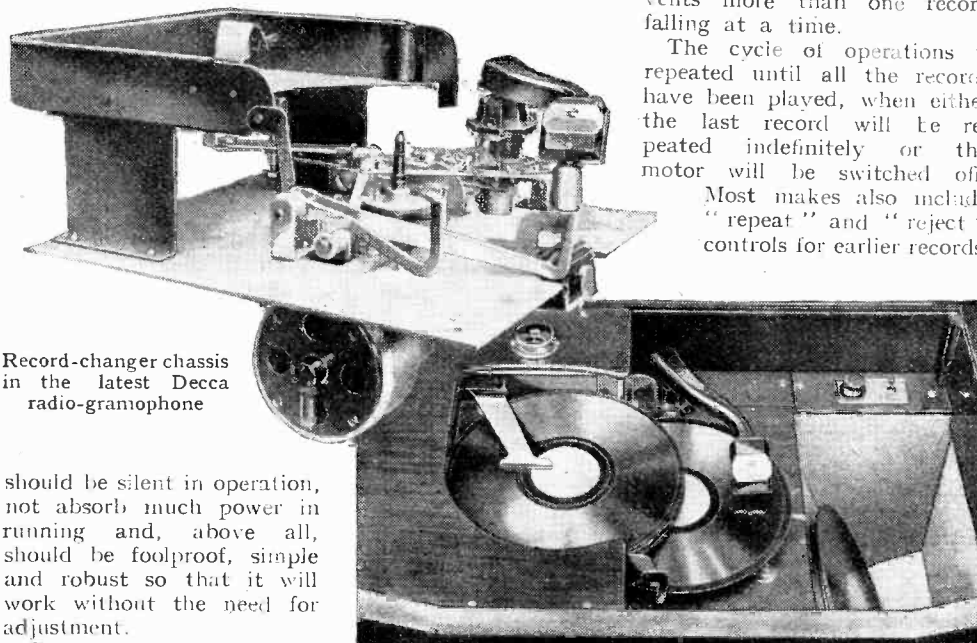

Record-changer chassis in the latest Decca radio-gramophone

should be silent in operation, not absorb much power in running and, above all, should be foolproof, simple and robust so that it will work without the need for adjustment.

Record changers in their present state fall rather short of this ideal. In the first place, as far as the writer is aware, all the changers at present on the market play only one side of each record. Series of double-sided records of symphonies

It will be readily seen that following this principle it is impossible to mix 10- and 12-inch records because the ledge designed for supporting the 12-inch disc will let the smaller ones fall through. In most

machines an adjustment gives alternative positions of the ledges—one for 10- and the other for 12-inch records. Further, the catch may not be capable of supporting all makes of standard record owing to slight variations in outside diameter. Great care should be exercised over this point and a comprehensive selection of records tried before buying. The writer has found some machines incapable of dealing with a variation of even $\frac{1}{8}$ inch from standard diameter.

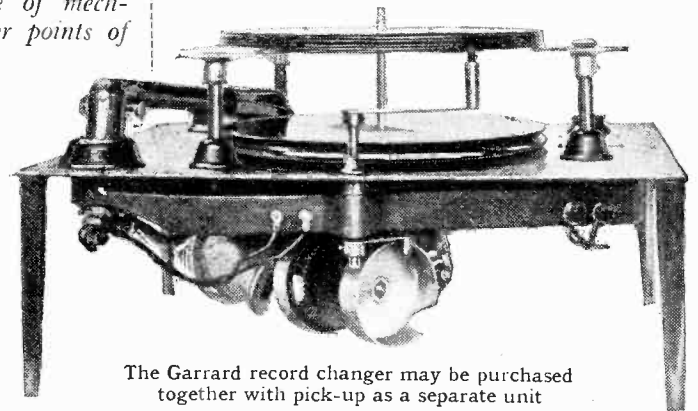

The Garrard record changer may be purchased together with pick-up as a separate unit

Another point to be watched is whether the throw-off mechanism will function on all records. Some changers are designed to work only with records having an eccentric run-off groove and the changing mechanism will not operate when a concentric groove record is played.

A point to notice is how smoothly the records fall down into place. Avoid a machine which treats the records harshly.

Little seems to be done as regards machines for playing both sides of a series of records. The problem, however, is being tackled and no doubt some solution will be found in due course, though the question of its commercial production is quite another matter since the manufacturing costs would necessarily be high. Another point to watch in buying a record changer is the length of time taken to effect a change. Some makes take as much as 20 seconds, while others make the change in as short a time as 5 seconds. Obviously the quicker the change the better, provided the records are not roughly handled in the process. Little can be said regarding the mechanism itself. The operations involved naturally call for a somewhat complicated mechanism and all other things being equal the machine with the least "works" should be chosen as being less likely to go wrong. Record-changing turntables are always electrically driven. A spring motor would not have sufficient power to work the mechanism and play all the records at one winding unless very cumbersome. The record-changing unit is generally already equipped with a pick-up, and the quality of this must not be neglected in buying. When testing, listen to the quality of the music to make sure that the motor is not causing unevenness. S. F. P.

Practical HINTS AND TIPS



AIDS TO BETTER REPRODUCTION

output voltage that will be applied to the grid is determined by the relative value of the two resistances; if it is desired to apply only half the available voltage, then they may be of equal value. With a sensitive pick-up and a receiver giving high magnification it will probably not be necessary to use more than one-quarter of the available pick-up voltage; in this case the resistance of R1 should be three times that of R2.

WHEN a pick-up is fitted to a receiver which derives its current supply from either batteries or A.C. mains there is virtually no risk of introducing a short-circuit across the source of supply. But when making this addition

D.C. Mains Precautions

to a D.C. mains receiver it is strongly advised that special precautions should be taken, as in some cases the pick-up and its external connecting leads will be at practically the full voltage of the mains with respect to earth. As a consequence, annoying or even dangerous shocks may be felt when handling the pick-up, and considerable damage may be done through short-circuits.

To be on the safe side and, what is equally important, to comply with both the word and the spirit of the various regulations, it is wise to make provision for isolating the pick-up from the mains. The arrangement embodied in the latest *Wireless World* D.C. receiver (the "Modern D.C. Three"), which is reproduced in Fig. 1, is to be advocated. It will be observed that the pick-up is entirely isolated, so far as D.C. voltages are concerned, by a pair of 1-mfd. condensers; in order that grid bias may be applied to the grid of the detector valve—or, rather, to the first amplifying valve, into which it is converted—a resistance R must be interposed. The value suggested will be found suitable in almost every case.

It should be added that where indirectly heated D.C. valves are used it may be necessary, in certain cases, to "tie

down" one side of the valve heater to the earth line by means of a large condenser (marked C in Fig. 1).

WHEN a receiver already includes a post-detection (or L.F.) volume control, it might appear that the addition of a pick-up would not involve the fitting of any additional means for regulating intensity. But the voltage output of most modern pick-ups is quite high, and if it be applied in full to the grid of the average detector valve

Fixed Pick-up Potentiometer

(temporarily converted into an L.F. amplifier) it is more than probable that overloading will be produced. The fact that volume may be cut down to any required level by operation of the existing post-detection control does not in any way obviate the ill-effects of this overloading.

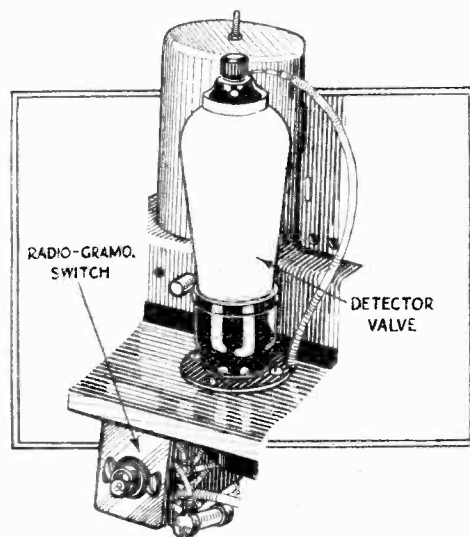

The radio-gramophone switch and detector valve of "The Modern D.C. Three" are mounted close together.

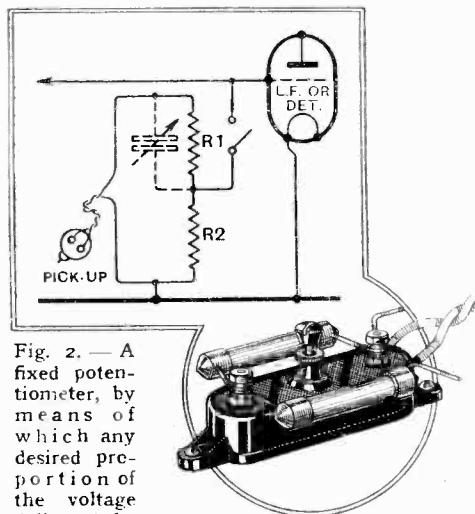

Fig. 2.—A fixed potentiometer, by means of which any desired proportion of the voltage delivered by a pick-up may be applied to the succeeding valve. A simple tone corrector, in the form of a semi-variable condenser, may be added.

In cases such as those we are considering the expense of an extra variable potentiometer may be avoided by shunting the pick-up with a fixed potentiometer, as shown in Fig. 2.

The combined ohmic value of the two resistances forming the potentiometer should equal that recommended by the makers of the particular pick-up that is to be used. The proportion of the pick-up

In order to compensate for the loss of high notes that may result from making a drastic reduction in applied pick-up voltage, the upper limb of the potentiometer may be shunted with a semi-variable condenser, as shown in dotted lines. To strengthen high notes the value of the condenser is increased by screwing its knob in a clockwise direction.

This method of tone control, though so simple, is extremely effective, especially if the associated resistances have high values. Assuming R1 to be something between 100,000 ohms and 1 megohm, a maximum capacity of 0.001 will be about right.

WHEN making provision for the addition of a pick-up to an existing receiver it is worth while to mount the radio-gramophone change-over switch as close as possible to the valve with which it is associated. In nine cases out of ten

The Radio-gramophone Switch

this valve will be the detector, which will have to deal with both H.F. and L.F. impulses.

Although this precaution is perhaps not of very great importance when the simplest form of switching is fitted, it is certainly highly desirable when a change-over switch is used, as, for

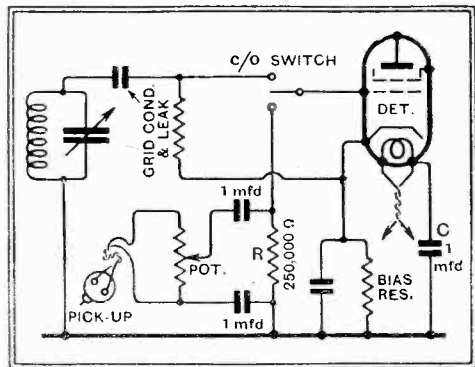

Fig. 1.—A safe method of connecting a pick-up to a D.C. mains set.

Practical Hints and Tips—

example, that shown in the accompanying Fig. 1. Two of the leads connected to the switch carry H.F. currents.

If it is impossible to mount the switch in close proximity to the valve it may be found necessary, in order to prevent instability, to shield one or more of its connecting leads in metal-braided sleeving. This course, though unobjectionable from most points of view, may add so much extra stray capacity to the associated tuned circuit that the waveband covered by the receiver will be restricted.

IN a self-contained radio-gramophone with built-in loud speaker a more or less serious resonance effect is sometimes caused by the transmission of vibration from speaker to receiver. Although modern valves are not usually microphonic, the

Insulation Against Vibration

possibility that this defect is responsible should not be ruled out entirely. Again, vibrations may be of such an amplitude that the condenser vanes will be affected, and this is particularly likely to cause a puzzling effect in a superheterodyne.

Whatever the precise cause of the trouble may be, mechanical insulation will generally cure it, and it is not a difficult matter to mount the entire receiver chassis on blocks of sponge-rubber or similar material. Of course, all the good

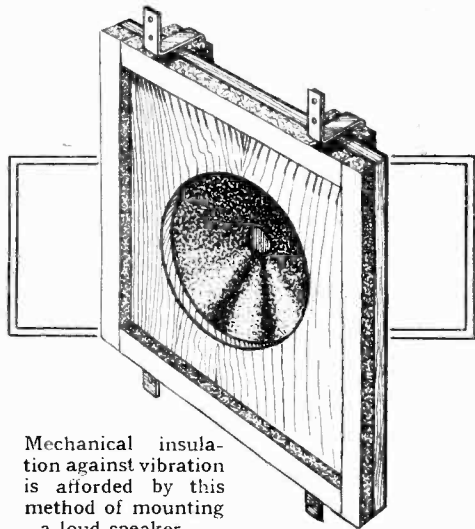

Mechanical insulation against vibration is afforded by this method of mounting a loud speaker.

done in this way would be entirely offset by screwing the control spindle bushes rigidly to the front of the cabinet; to use an electrical analogy, this would short-circuit the mechanical insulation afforded by the rubber. When this plan is adopted it is generally best to make the control panel integral with the receiver chassis, and to cut a vignette in the face of the cabinet to expose the control knobs.

It will sometimes be easier to attack the problem from an opposite angle, and to insulate the loud speaker itself in such a way that the vibration from it cannot be transmitted to the receiver through the woodwork. To do this the loud speaker is screwed to a sub-baffle measuring perhaps a foot square, which is mounted behind the "fret" of the cabinet. Again, strips of insulating material, such as felt

or sheet sponge-rubber, must be interposed between the sub-baffle and the cabinet, as suggested in the accompanying sketch. Further, blocks of insulating material must be placed under the clamps by which the sub-baffle is held in position.

These precautions should remove the cause of certain types of resonance, and also of howling, provided the latter be due to mechanical reaction, and not to electrical reaction. Before going to the trouble of providing insulation in the manner suggested it is not a bad plan to make a test by temporarily removing the receiver from its cabinet, connecting the loud speaker by long leads, and then observing whether performance of the set is improved.

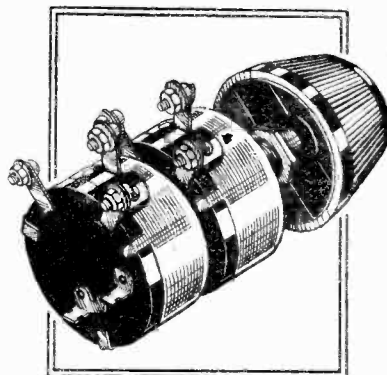

A pair of ganged Rotor-ohm potentiometers, suitable for a combined radio and gramophone volume control. An on-off switch is included.

ALTHOUGH it is not the purpose of this note to suggest that the number of control knobs on a receiver or radio-gramophone should be reduced to such an extent that desirable adjustments cannot be made, it is always worth while to

Twin Volume Controls

simplify operation if this can be done without prejudice to efficiency. It is particularly desirable to do so when the set is to be operated by non-technical members of the household.

It is obviously all to the good if the same control knob which determines the loudness of radio reproduction shall also be operative when the set is converted for use with a pick-up. In a few cases it is just possible to arrange matters so that the potentiometer which customarily performs this duty shall act in both cases, but as a rule a relatively complicated system of change-over switching will be necessary, and so the plan is not one to be generally recommended.

But an exactly similar effect, from the point of view of the user, can be brought about by using a double-unit potentiometer of the type that is now obtainable commercially. Both

potentiometers are mounted on the same spindle, and are actuated by a single external knob.

In wiring up, the two potentiometers should, of course, be treated as separate units—as indeed they are—but care should be taken to see that the ends of the resistance elements are connected in such a way that the volume of reproduction for both "radio" and "gramophone" is increased by rotating the knob in the same direction.

IT will hardly be necessary to say that the usual procedure of inserting a pick-up in the grid circuit of a detector valve is not applicable when diode detection is employed. The two-electrode detector is no more an amplifier than is a crystal, and without a very elaborate switching scheme cannot be made to act as one.

Diode and Pick-up

The rule to apply when converting such sets for gramophone reproduction is to connect the pick-up in the grid circuit of the L.F. valve which immediately succeeds the diode. In order to isolate the latter a change-over switch may be employed, but when dealing with battery-operated sets the somewhat simpler plan shown diagrammatically in Fig. 3 may be preferred. In addition to the usual switch by means of which the pick-up is connected, another switch is connected in the diode filament circuit; this should be opened when the set is being used for gramophone reproduction. Failure to observe this precaution will introduce distortion, but the presence of the diode will do no harm providing its filament is cold. The incidental capacities associated with the diode are so small that their presence is most unlikely to cause any falling off in quality, while the load resistance, which is effectively in parallel with the pick-up, is so high that it will have virtually no effect.

Of course, this arrangement applies only to battery-operated sets, in which, incidentally, it is economical to make provision also for extinguishing the filament of the H.F. valve while the pick-up is in

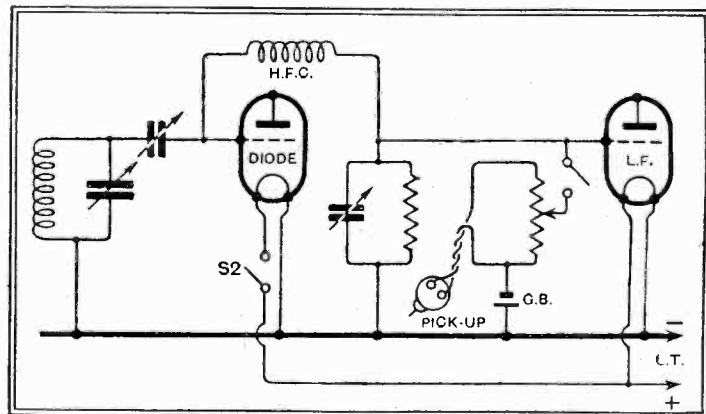

Fig. 3.—By interrupting the filament circuit of a diode detector, a pick-up may be connected to the grid of the succeeding L.F. valve in the simple manner shown.

use. These various operations can be effected simultaneously by means of a single multi-contact switch.

SYNTHETIC SOUND



INHUMAN perfection of articulation and other remarkable phenomena are claimed as possible with the new system of artificial sound production now being experimented with by a German acoustic expert, Rudolf Pfenninger. The method is based on the variable area system of sound recording on film.

By HERBERT ROSEN

Voices from Pencil Strokes

THERE seems no limit to the possibilities of the sound film. Only recently an Austrian firm produced an interesting type of record consisting of nothing more nor less than long rolls of paper tape; now we learn that a German, Rudolf Pfenninger, with the assistance of the Bavarian Film Company, is producing from paper strips records of human speech that no lips have ever spoken! Records of songs, too, that no human voice has ever sung!

Studying Zig-zags

This miraculous-sounding achievement is the result of a lengthy and gruelling study, under the microscope, of the characteristic shapes of the zig-zag outlines of innumerable sound-on-film records—such as are used for "talkies" in which the variable-area system is employed. Like a five-year-old learning to read and write, letter Pfenninger mastered the appearance of the various sounds as recorded on the films, so that in time he was able to "read" a film as well as if it were the strip out of a tape-

machine. But this was only the first step; presently he developed such a virtuosity that he could draw, with a pencil, his own zig-zag outlines, which,

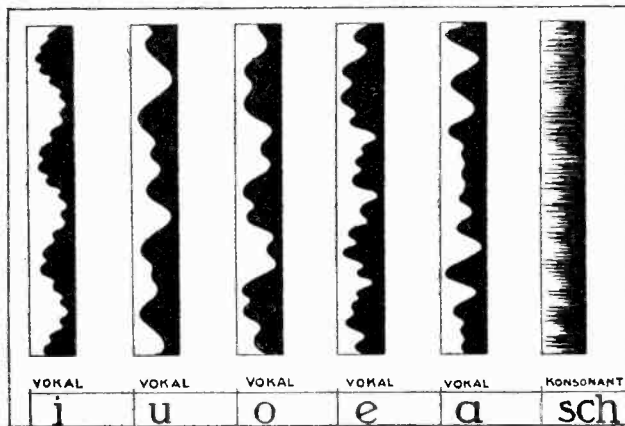

Wave forms, drawn by Herr Pfenninger, representing the five vowel sounds and a commonly used German consonant.

when passed through the reproducer, sounded just like human speech.

Nowadays, with increasing skill, he can even improve on the product of us poor imperfect humans, smoothing and polishing his curves until his results give an inhuman perfection of articulation which even a B.B.C. announcer can never attain! It is even reported that in his lighter moments Herr Pfenninger can produce the most amusing effects by playing all sorts of tricks with the human voice.

The general idea underlying this work is not new, but we believe that efforts have not hitherto been directed towards producing results of such precision nor on so ambitious a scale.

Helping the Dumb Talk

It is almost impossible to foresee just where this new tech-

nique will lead us. Is it, for instance, possible that the music of a sound film will be recorded by one man at his desk instead of by an orchestra in a large studio? And—the bright idea occurs to us as we write—will a dumb man be able to talk by tapping out his speech on a special keyboard like that of a typewriter but actuating artificial sounds instead of printed letters? And will our

politicians, addressing their constituents, scorn to rely on their poor human larynxes and use instead the awe-inspiring perfection of Science's latest achievement?

But, to refer to a possible application of more immediate utility, could not the principle be applied to taking the "Yank" out of American films so that those little peculiarities of speech which jar the nerves of B.B.C.-trained ears could be suppressed without changing the film actors or going to the expense of a specially recorded film for English

patrons of the cinema?

New Amateur Call-Book

THE winter quarterly issue of the "Radio Amateur Call-Book" has now been issued, and is obtainable in Great Britain from Mr. F. T. Carter, Flat A, Gleneagle Mansions, Streatham. Owing to the dollar exchange the price is now 6s. 6d., post free, for single copies, or 21s. for the four quarterly issues.

The list of call-signs, names and addresses of all known amateur transmitters in the world now extends to 185 closely printed pages, and is, we believe, the only one of its kind now published, since, for reasons of economy, the American Government has ceased issuing their official list of American amateurs.

In addition to the main list, short-wave enthusiasts will find other useful information, such as Press and weather reports, and a fairly comprehensive list of commercial short-wave stations.

If we may judge by our own correspondence there are still many short-wave listeners who do not know of this publication, despite the fact that it is often mentioned in our columns, and to these we would say: "Now you know what it is and where you can get it."

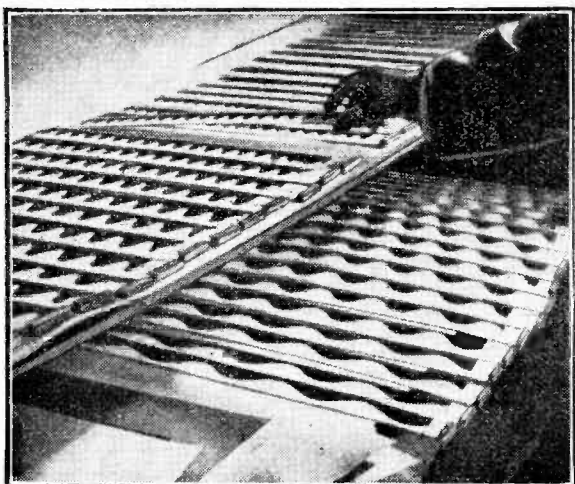

To facilitate rapid preparation of records Herr Pfenninger has manufactured stencils.

BROADCAST

By Our Special Correspondent

BREVITIES

Hypothesis

A DELIGHTFULLY characteristic theory has been evolved by the B.B.C. to account for the increase in the number of complaints concerning electrical interference with broadcast reception. It is that the programmes are so much more entertaining to-day that people cannot tolerate interruptions which would have gone unnoticed two or three years ago.

Uncanny Increase

Be that as it may, the figures are undoubtedly startling. In 1930 only 3 per cent. of the technical correspondence received related to man-made static; a year later it had risen to 19 per cent., and in 1932 to no less than 39 per cent.

Crackles as a Radio Miracle?

This is out of all proportion to the growth in the number of licence holders. There are probably several reasons for the increase. For example, listeners are undoubtedly more critical of results than they were a few years ago; probably crackles were once accepted as part of the miracle of radio.

The vastly increased popularity of domestic electrical appliances must also account for a good deal of noise.

By way of remedy the B.B.C. firmly plumps for the silencing of electrical apparatus at the time of manufacture.

Defeating the Born Querist

Taken *en masse*, the technical correspondence received at Broadcasting House is definitely diminishing, and the B.B.C. put this down to the new vogue of "the unanswerable pamphlet." The various brochures now distributed to listeners in trouble are written in such simple, foolproof terms that even the born querist has difficulty in finding ambiguities worth writing about.

Should It?

TWO well-known journalists go to the microphone on February 11th to hold a discussion in the "Should they be Scrapped?" series. They are Mr. Hamilton Pye, former editor of a London paper and international correspondent, and Mr. Tom Clarke, former editor of an Australian paper, present editor of a London paper, and the living embodiment of modern journalistic methods as introduced by the late Lord Northcliffe. The subject of their discussion is "Should the Press be abolished?"

Autograph Hunters at Large

HENRY HALL is threatened with writer's cramp. He tells me that when by special invitation the other day he attended the Lancashire Masonic Ball in Liverpool he conducted just one number by the local dance orchestra. The rest of the evening was taken up in signing autograph albums!

Making the Empire Dance

By special request, numbers by the B.B.C. Dance Orchestra are now included in every Empire transmission.

Provincial Protests

DIE-HARDS in the Provinces are still urging the B.B.C. to restore the local orchestras, though I feel sure that their efforts will come to naught. It is true that opinion is divided even at headquarters on whether the regions should each have their own musical combination; the Music De-

were given back its orchestra of 38 players, northern listeners would still complain, for their local orchestra would be unable to offer them the more ambitious symphonic works and would only occupy programme time which could be much better filled by the big orchestra in London.

Arguing Over the Atlantic

EVEN for those of us who can afford to ignore war debts and reparations the broadcast debate on this topic between students of Yale and Cambridge Universities on February 11th should hold an uncommon technical interest.

The pros and cons will be tossed to and fro over the Post Office Transatlantic 'phone, and I can imagine nothing more thrilling than a really heated debate over the watery wastes.

Presumably Father Neptune will preside.

Miss Dulcima Glasby

GOOD may yet come of the regrettable resignation of Miss Dulcima Glasby from the staff of the B.B.C. This talented adaptor of plays and books for broadcasting has lacked the time during her seven years of service with the Corporation to produce very much original work of her own; yet the one radio play that Miss Glasby did write—"Obsession"—was voted a rare success. I hope that her pen will soon be active in the production of original radio plays, of which—as Mr. Val Gielgud knows only too well—there are far too few.

A Lot in a Name

SO Maschwitz is Maschwitz and Marvell is Marvell, and never the twain shall meet. Which means that although Mr. Eric Maschwitz, the radio playwright, better known as "Holt Marvell," had intended to alter his name to the latter by deed poll, circumstances have ruled otherwise. The rumour published, fierce telegrams hurtled across from relatives in Poland intimating that the family was coming over to argue the point. The hasty reply said in effect, that, for the present, the writer would remain, theirs devotedly, Eric Maschwitz.

Physical Jerks.

THE vision of a hypothetical apoplectic colonel seems to loom up in the eyes of the B.B.C. whenever radio "physical jerks" are suggested. The official attitude seems to be that the broadcasting of early morning exercises would lead elderly or delicate persons to attempt the impossible with baleful results, and that the responsibility for these (imaginary) disasters would be laid at the door of Broadcasting House.

The Reason?

The argument is so easily answered that one wonders whether there is not some underlying deterrent to ante-breakfast broadcasting. Are the B.B.C. late-risers?

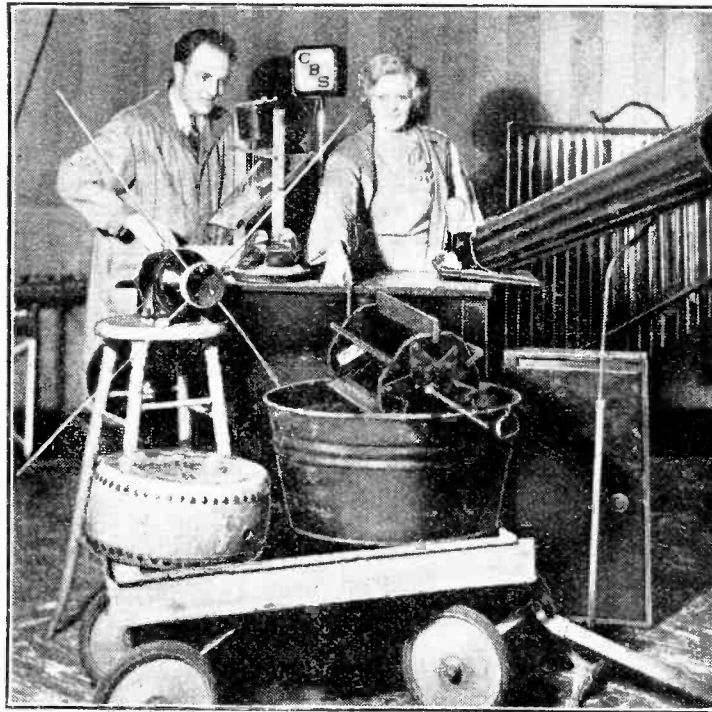

NOISE MAKING IN U.S. It is interesting to compare this picture with that of the B.B.C. "effects" department published in our issue of January 20th. Above are the appliances for producing storm and other noises in the Columbia studios. The artistes can depict falling rain, wind moaning, footsteps on gravel and other ominous effects.

partment, I hear, are in favour of such a scheme, but practical and financial considerations far outweigh the musical and the sentimental.

Drawbacks of Local Orchestras

The B.B.C. contend that the really big works which everyone wishes to hear can only be performed by the B.B.C. Symphony Orchestra. If, say, the Northern Region

Warmed-Up Thrills

MR. LIONEL SECCOMBE made a splendid attempt to give us the excitement of a running commentary in his eye-witness account of the Petersen-Pettifer fight, but did not quite succeed. The description made me think of a good dinner warmed up a second time for supper.

Why Not the Blattnerphone?

A friend suggests that the B.B.C. might well copy the German method of taking an actual record of events which cannot for various reasons be broadcast at the moment of happening. If Mr. Seccombe could have given a running commentary over the line to Broadcasting House, his remarks—plus the crowd noises—being Blattnerphoned, the item would have been much more successful when re-transmitted half-an-hour later.

I commend the idea to Mr. Gerald Cock, the "O.B." chief.

"Hassan"

A BRILLIANT cast of twenty-five has been engaged for the broadcast of "Hassan," part one of which is to be heard on the National wavelength on February 7th and part two on the Regional wavelength on February 10th. The name part will be played by Henry Ainley, that of the Caliph by Ronald Simpson, Ishak, his minstrel, will

be Leon Quartermaine, and Rafi, King of the Beggars, Ion Swinley. The Executioner will be Abraham Sofaer, and the narrator, Harman Grisewood.

Just the Same in China

IN its struggle with conflicting interests, such as the General Theatres Corporation, the B.B.C. should gaze eastwards for a few moments and take courage in the thought that it has a companion in distress in far-away China. According to the *Radio Corriere*, the Chinese theatrical interests, which have been in the business since two or three thousand B.C., are savagely accusing the National broadcasting authorities of ruining the theatre through the medium of the loud speaker.

The Only Way

A few months ago, it seems, young and old alike in the cities of Shanghai, Peking and Nankin, would sit around the theatrical booths and watch the same old antics that had amused their forefathers for generations. Now, however, they turn their backs on the mummies, preferring the more sophisticated radio entertainment.

The Chinese theatre ought to amalgamate with the radio business while the going's good. Alternatively, it might seek an exclusive alliance with the television and cinema interests.

Jack Payne Again

ANOTHER broadcast by Jack Payne with his Band takes place in the National programme for February 13th. These old friends of broadcasting are giving performances before the microphone at the rate of one a month to enable them to keep in touch with the listening public, who now have the opportunity of seeing them in the flesh as well as hearing them by wireless.

A Radio Mass

"LA MESSE du Cinéma et de la Radio" was celebrated at the Madeleine, Paris, on January 19th, when Archbishop Verdier, addressing a large congregation, declared that the "intellectual and moral welfare of the multitude" was largely in the hands of those controlling broadcasting.

Do Americans Copy Us?

A WASHINGTON friend tells me that "three cardinal crimes" in every-day and especially in radio speech have been specified by Miss Dagmar Perkins, president of the U.S. National Association for American Speech. They are: (1) Failure to open the mouth widely enough; (2) ignorance or carelessness of diction; and (3) too much imitation of English.

"What we want," said Miss Perkins, "is pure and beautiful American."

ON THE SPOT

VISITS TO FOREIGN BROADCASTING STATIONS

V.—Radio Toulouse, 779 kc. 385.1 m.

"ICI, Radio Toulouse!" What listener with any pretensions as an ether searcher has not heard that call? Not long ago I visited the station and studios in the surprisingly humble building known as "Villa Schmitt," just outside the town. The famous "war" between the privately owned Radio Toulouse and the official Toulouse P.T.T. was smouldering then, as now. In those days Radio Toulouse was forbidden to use a land line from studios in town, so the owners were using, and continue to use, as studios the "Villa Schmitt," which, incidentally, is a converted pig farm. The "war" now centres round the official refusal (up to the present) to grant Radio Toulouse a permit to broadcast on 100 kW. from the new transmitter at Château d'Agnan. All is ready for regular transmission from this imposing mansion.

The Post Office station at Toulouse is known as *Toulouse Pyrénées*, and is the sort of station specially designed to enable club secretaries to bestow gold medals on members who succeed in hearing it.

WANDERING WAVE.

Situated on high ground in a smiling landscape, the old Château d'Agnan makes an excellent modern broadcasting station.

The main studio at Radio Toulouse is a converted pig-sty. The inset sketch shows the studio building and the masts of the old station.

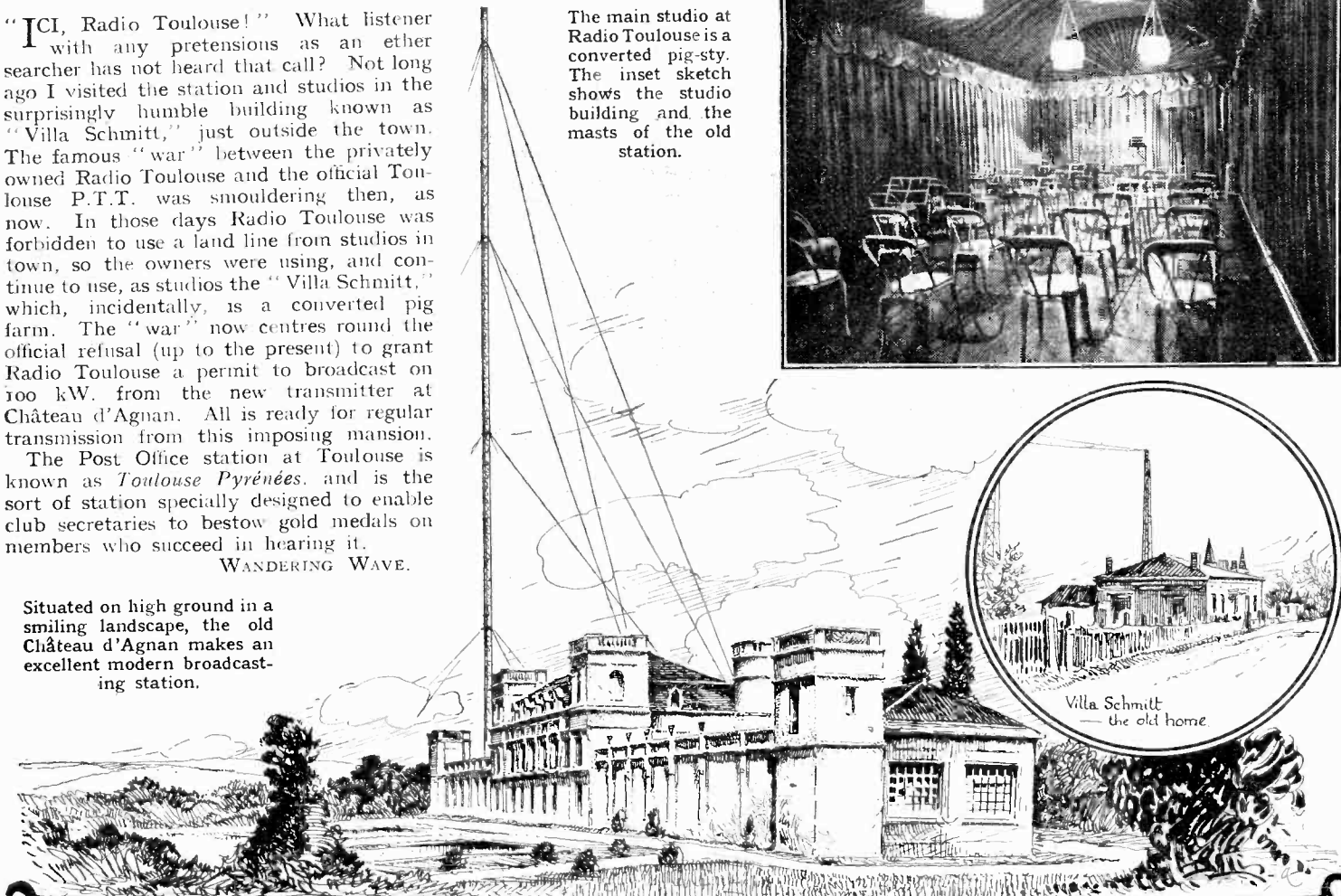
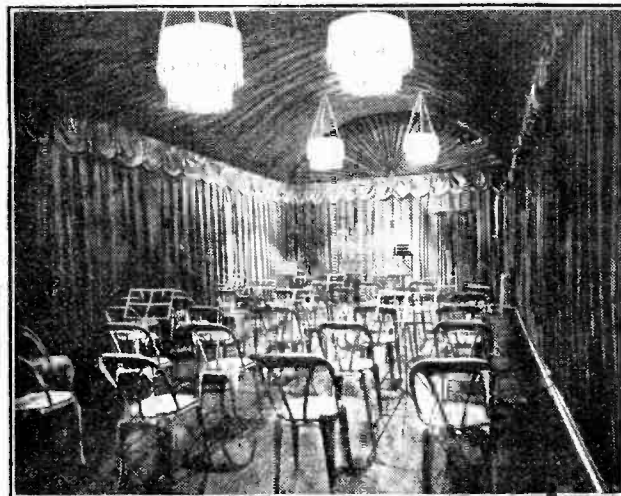

READERS' PROBLEMS

Dual Loud Speakers

WE are asked to summarise briefly the main advantages of so-called "dual compensated" loud speakers, which consist of a pair of instruments specially matched for working in conjunction with each other.

Although the subject is not entirely free from controversy, and further, not all dual loud speakers are planned with precisely the same objects in view, the matter may be summed up in general terms without risk of being seriously misleading.

As a rule, the frequency range covered by dual loud speakers of the normal type is but little wider than that of a single loud speaker of similar design. This does not apply to designs in which one of the units is intended to act almost solely as a reproducer of the higher audible frequencies.

THESE columns are reserved for the publication of matter of general interest arising out of problems submitted by our readers. Readers requiring an individual reply to their technical questions by post are referred to "The Wireless World" Information Bureau, of which brief particulars, with the fee charged, are to be found at the foot of this page.

there is a distinct risk of introducing instability, but the difficulties in this direction are by no means insuperable, as the amount of extra magnification needed is relatively small. Even this possibility of trouble might be overcome almost entirely by adopting diode detection, a plan suggested by another reader, who already uses this method in his receiver with extremely satisfactory results, and wishes to retain its advantages in combination with the additional ones offered by the Q.P.P.

affecting the brilliancy of reproduction, which is a special feature of his set, but doubts whether the device as described would be suitable for his own set.

We think that in this case better elimination would be obtained by using lower inductance and higher capacity values in the suppressor. It is suggested that the coil in the unit should be halved in inductive value by winding on only about 70 per cent. of the number of turns specified, and that all capacities should be doubled. This means that a tuning condenser of 0.001 mfd. will be needed, but components of this value are obtainable commercially without very much difficulty.

More Voltage Step-up Needed

IT is not difficult to recognise the signs of detector overloading, which is a more common defect in present-day receivers than is generally realised. In very bad cases there may be a wipe-out effect, strong signals being tuneable at two distinct positions on the dial. This is often due merely to excessive signal strength.

But it will sometimes be painfully evident that reasonable volume cannot be obtained when strong—as opposed to over-strong—signals are being received, and for this the detector must always be suspected if it is known that the output stage is free from blame. Yet another indication is that tuning appears to be excessively broad when receiving fairly strong signals, but is sharpened appreciably when weak ones are tuned-in.

These various symptoms are described in recent letters, and we are asked to suggest how matters may be improved.

Although each case should perhaps be dealt with individually, it may be pointed out that the power-handling capabilities of a grid-leak detector may always be increased by applying a greater H.T. voltage to its anode. Even when the maximum voltage available is already being used a similar result might sometimes be achieved by reducing the value of decoupling resistance, but, of course, there is always the risk that this may produce instability. Another sovereign remedy, and perhaps the safest to apply, is the substitution of an L.F. transformer having a greater step-up ratio than the component at present in use. If quality of reproduction is to be maintained the new transformer should be of good design, and this is a case where undue economy should not be exercised.

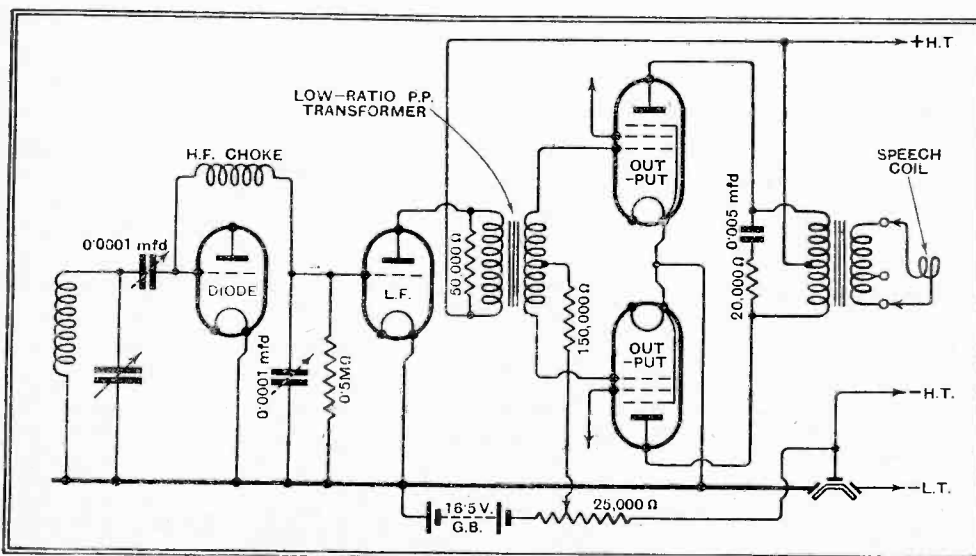

Fig. 1.—Quiescent push-pull output system, preceded by an intermediate L.F. stage and a diode detector.

Matched pairs, in which individual units have slightly different characteristics, are capable of a power-handling capacity of more than twice that of a single similar instrument; further, there is a considerably greater immunity from resonances, since each instrument tends to damp out the resonance of the other. Again, some improvement in sensitivity is to be anticipated.

Superior-quality Q.P.P.

A NUMBER of readers have asked whether there is not some simple way of using existing push-pull L.F. transformers with a low step-up ratio (in the order of 1:3.5) in a quiescent push-pull receiver, on the lines of that recently described in this journal.

With any practical grid detector, we fear that without the help of a considerable voltage step-up, as afforded by the special types of L.F. transformers produced specially for this new circuit, it would be impossible to feed a quiescent push-pull output stage directly from the detector valve. Consequently, an intermediate L.F. stage must be interposed if a low-ratio transformer is to be used, and we do not know of any satisfactory alternative to this plan.

As a result of adding this extra valve

system. He asks us to suggest a suitable circuit arrangement.

The circuit given in Fig. 1 should meet the needs of this reader. From the L.F. valve onwards, the arrangement is precisely the same as that of the "Quiescent Push-pull Two," while the diode detector connections are quite conventional. In spite of the fact that an extra valve is employed, the drain on the H.T. battery will not be increased, as the diode valve requires no anode current.

Of course, an arrangement of this nature may be preceded by an H.F. stage.

For Low-Impedance Circuits

AS has already been stated, the "Whistle Suppressor" (*The Wireless World*, October 28th) works at its best when connected to a circuit of high impedance.

A reader who is using, for local-station reception, a "quality" receiver with low gain resistance-coupled L.F. circuits and a low-impedance output stage, is troubled by whistle interference from foreign stations after dark; this is by no means an uncommon occurrence at this time of year, even when the receiver is of low sensitivity. He concludes, quite rightly, that a device like the "Whistle Suppressor" should provide a satisfactory cure without appreciably

The Wireless World

INFORMATION BUREAU

THE service is intended primarily for readers meeting with difficulties in the construction, adjustment, operation, or maintenance of wireless receivers described in *The Wireless World*, or those of commercial design which from time to time are reviewed in the pages of *The Wireless World*. Every endeavour will be made to deal with queries on all wireless matters, provided that they are of such a nature that they can be dealt with satisfactorily in a letter.

Communications should be addressed to *The Wireless World* Information Bureau, Dorset House, Tudor Street, E.C.4, and must be accompanied by a remittance of 5s. to cover the cost of the service. The enquirer's name and address should be written in block letters at the top of all communications.

The Wireless World

THE
PRACTICAL RADIO
JOURNAL
22nd Year of Publication

No. 702.

FRIDAY, FEBRUARY 10TH, 1933.

VOL. XXXII. No. 6.

Proprietors: ILIFFE & SONS LTD.

Editor:

HUGH S. POCOCK.

Editorial Offices:

116-117, FLEET STREET, LONDON, E.C.4.
Editorial Telephone: City 9472 (5 lines).

Advertising and Publishing Offices:
DORSET HOUSE, TUDOR STREET,
LONDON, E.C.4.

Telephone: City 2846 (17 lines).
Telegrams: "Ethaworld, Fleet, London."

COVENTRY: Hertford Street.

Telegrams: "Cyclist, Coventry." Telephone: 5210 Coventry.

BIRMINGHAM:

Guildhall Buildings, Navigation Street, 2.

Telegrams: "Autopress, Birmingham." Telephone: Central 4857.
"Blackfriars 4112 (4 lines).

MANCHESTER: 260, Deansgate, 3.

Telegrams: "Iliffe, Manchester." Telephone: Blackfriars 4112 (4 lines).

GLASGOW: 26B, Renfield Street, C.2.

Telegrams: "Iliffe, Glasgow." Telephone: Central 4857.

PUBLISHED WEEKLY. ENTERED AS SECOND CLASS MATTER AT NEW YORK, N.Y.

Subscription Rates:

Home, £1 rs. 8d.; Canada, £1 rs. 8d.; other countries abroad, £1 3s. 10d. per annum.

As many of the circuits and apparatus described in these pages are covered by patents, readers are advised, before making use of them, to satisfy themselves that they would not be infringing patents.

CONTENTS

| | Page |
|--|------|
| PROGRAMMES FROM ABROAD, pp. I—XXIV | |
| Editorial Comment | 105 |
| The Story of the Small L.F. Transformer | 106 |
| The All-wave Monodial Super | 109 |
| News of the Week | 113 |
| Unbiased | 114 |
| Simple Tone Controlled 12-watt Amplifier | 115 |
| More About the Quiescent Push-pull Two | 116 |
| Ekco Superheterodyne Reviewed | 118 |
| Practical Hints and Tips | 120 |
| Broadcast Brevities | 122 |
| Letters to the Editor | 123 |
| Readers' Problems | 126 |

EDITORIAL COMMENT

Nation Shall Speak Peace Unto Nation

Justify the B.B.C.'s Motto

WE may be excused if from time to time we have wondered what prompted the British Broadcasting Corporation to adopt as its motto "Nation Shall Speak Peace unto Nation," since, although the Corporation has been in existence for more than ten years, we can recollect no instance when broadcasting has been used for communication between one nation and another, except on certain rare occasions when there has been a re-broadcast of some individual programme originating in another country.

There would seem to be ample scope for the B.B.C. to make their motto effective. The difficulty in international broadcast communication in Europe centres around the language problem. Music is internationally understood, but the language differences make national programmes, insofar as talkies are concerned, appreciated abroad only by those very few listeners who have a sufficient knowledge of the language used to understand them.

Why should not the co-operation of European broadcasting authorities be arranged in a scheme whereby talks would be broadcast in languages other than those of the country from which the broadcast originated? These talks would have to be arranged on the understanding that they would not be in the nature of propaganda. The motto, "Nation Shall Speak Peace unto Nation," would guide the choice of subject matter. There should be nothing in the talks calculated to give offence to the country in whose language these broadcasts were conducted. As a commencement, we would suggest talks written by political heads

and leaders of public thought in each country, which would express national viewpoints on important questions of the day; other talks would deal with domestic life, education, recreations, etc. These talks would, in the case of this country, be translated into the various languages of the Continent and given as a series from the national transmitters. Similarly, we would like to hear corresponding views in English talks from the capitals of Europe.

We cannot but believe that talks of this nature would have an influence not only educational, but social, and would help to bring about a better understanding between nations than it is ordinarily possible to achieve through the existing channels of intercommunication. We commend this proposal to the B.B.C. and would urge them to consider whether, on some such lines as we have briefly outlined, they could not set the example and invite other broadcasting authorities to help to stimulate interest between European nationals and so justify the Corporation's motto, "Nation Shall Speak Peace unto Nation."

Foreign Stations

Readers' Views

READERS have shown very great interest in the subject of foreign and local listening discussed in our issue of January 27th. In this issue we publish a representative selection of letters received.

In forming opinions on this question let us be careful to remember that fading can now be practically overcome with automatic volume control and that there is every likelihood of legislation controlling electrical interference in the near future. Manufacturers, in deciding upon their future policy, must take these factors into consideration.

The Story of the Small L.F.

Transformer

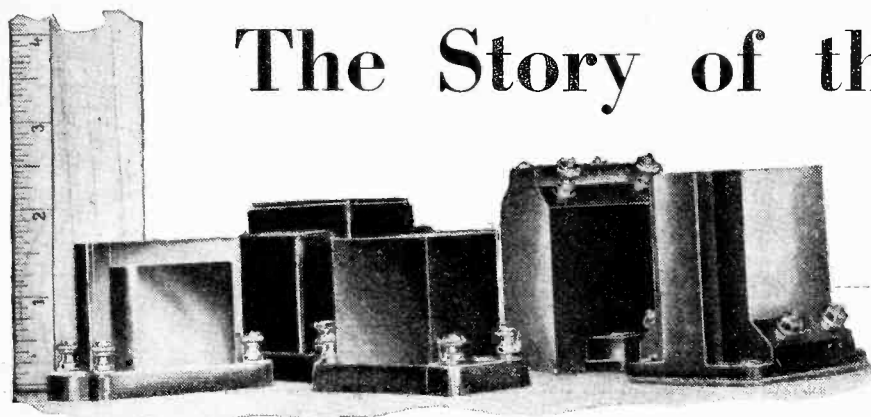

The Advantages of Alloy Cores

By L. S. CRUTCH, B.Sc.

THE introduction of the high-permeability core has been responsible for the appearance during the last two years of a considerable number of L.F. transformers of quite Lilliputian dimensions. When using these components not only is there much saving of space but there are electrical advantages which are explained in this article in terms easily understood by the less advanced student of wireless.

JUST what artifice on the part of the maker of L.F. transformers has enabled a shrinkage in dimensions to be brought about during the last two years may not be quite clear, although reference is usually made to the special properties of some particular core on which the transformer is wound. It is hoped in this account to give some idea of what lies behind this large reduction in size, and how these midgets compare with their larger predecessors. We shall also see how circuits need slight modification from former arrangements if we are to use this new piece of apparatus to its fullest advantage.

What is Permeability?

We use a transformer as a means of coupling one valve to the next in an amplifier, and as such it is expected to hand on to the next valve the voltage presented to it by the first, at the same time further justifying its existence by magnifying this voltage several times before handing it on. To do either of these things it must have inductance; and inductance, as is well known, is obtained by winding turns of wire over a core which is usually iron. True, the winding would have inductance if the iron were not present, but its value would be very much less than when it is present. The property of iron in causing an increase in the inductance of winding when situated in its magnetic field is called its permeability, and it has this property by virtue of the fact that, being a magnetic material, it has a much lower "magnetic resistance" than the air or other material which would otherwise be in the field of the winding.

This permeability, as we shall see, is a very variable quantity, and depends not only on the material itself, but also on the conditions under which the material is used. The permeability of any non-magnetic material is unity, and it is a property of any magnetic material that it has a permeability greater than unity, or, in other words, that it has the property of increasing the magnetic effect of a coil

of wire carrying a current. We want to be quite clear that inductance is a property associated with a changing magnetic field, it has no being when the field is steady and unchanging.

In any amplifier using valves there must be an impedance in the anode circuit if the voltage amplification from the valve is to be usefully employed. Furthermore, if the amplifier is to work over a range of different frequencies and is to give substantially equal amplification at all frequencies, this impedance must be large in comparison with the internal resistance of the valve which precedes it. In the case of an intervalve transformer this impedance is made up of the resistance

merely in a blocking sense, in that it involves no dissipation of energy as occurs with what is more strictly termed an "ohmic resistance."

The value of the reactance is given by the product of the frequency in question, a factor which happens to be 6.28 and the inductance; which brings us back to this inductance question in the transformer. It is evident that it is needed, and the question to be considered is how it is obtained. If we relied entirely on the air we should require something quite unwieldy and useless as an economic proposition. Ordinary iron bars would be an improvement, but thin sheets of soft iron provide a much better solution, having an effective permeability, under the conditions in an amplifier, of between three and four hundred. The amount of iron needed to produce a given value of inductance will depend upon the number of turns in the winding, so that for more turns less iron will be needed. As in the design of almost any piece of electrical apparatus, different quantities of two things will all produce about the same result, but certain carefully determined amounts will produce the best result at the lowest cost of production. Thus it is not possible to use very little iron and a great deal of wire or very little wire and a large quantity of iron. Intervalve transformers of good quality using ordinary soft-iron cores are necessarily bulky, and it used to be possible to estimate the goodness of a transformer by its size. Even then it was a bit risky, but now it is definitely out of the question.

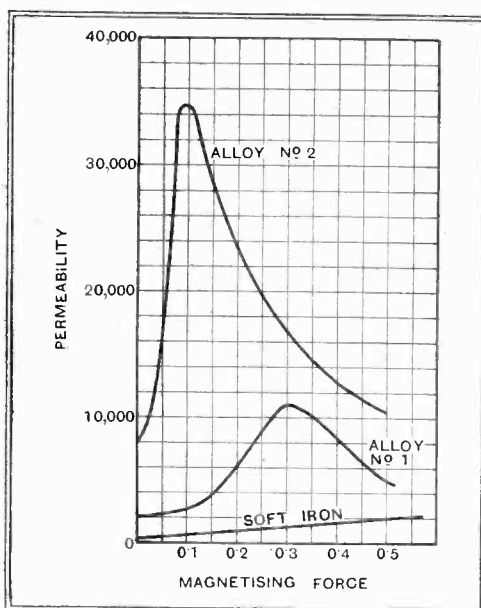

Fig. 1.—The enormous increase of permeability when certain metals are alloyed with iron can be seen from these curves.

New Alloys

and reactance of the windings. This resistance is the effective copper resistance of the winding, with an additional amount due to energy losses in the iron circuit. In any case this is usually small in comparison with the reactance of the windings. This reactance is the "resistance" offered to an alternating current, but

Some ten years ago, when research work was being carried out on core materials in connection with loading coils used for long-distance telephony, it was discovered that the alloying, or intimate mixing, of quantities of other materials with the soft iron had the effect of very considerably increasing the magnetic permeability. Nickel was the principal constituent added, although traces of copper, chromium, and molybdenum were also

The Story of the Small L.F. Transformer— found to be beneficial in certain circumstances. The results obtained in terms of this property "permeability" were quite astonishing, and are best realised by looking at the curves in Fig. 1, which give a comparison between ordinary soft iron and two alloys of iron containing nickel and small quantities of other metals. A first inspection probably gives the impression that these alloys are enormously superior to the ordinary iron, but, before jumping to any conclusions, we have to consider a number of other factors, with the result that, although the alloys are definitely superior, the relative usefulness is rather more favourable to the iron than the graph would indicate.

This type of graph, taken under laboratory conditions, does not tell all the story, and some of the results shown there cannot in most cases be realised in ordinary use. A great deal of research work has been done since the original discovery, and is still in progress, on ways of using these alloys under practical conditions so as to get the advantages of the high permeability without having to be extremely careful of the way in which the material is used. The results, as exemplified by the modern nickel-iron transformer now obtainable, have been largely successful.

It will thus be seen that with a material now available having a permeability many times greater than that of iron the same inductance as before can be obtained with a much smaller number of turns. Actually, as explained before, a compromise is adopted and both the size of the core and the amount of wire is reduced, with the result that the overall dimensions of the transformer are considerably reduced. The cost can also be reduced, but not at the same rate as the size, because, although less wire is used, these special alloy cores are more costly than soft iron.

Leakage Between Windings

Let us now consider what changes, good or otherwise, have been made in the performance of the transformer. We are accustomed to see published curves of transformer amplification at different frequencies and to regard a long, horizontal straight line over most of the scale as the sign of a good transformer. Fig. 2 shows some such curves, which are straight over a large proportion of the frequency range but fall away at the extremities. Sometimes there is an upward bulge near the upper end, as shown by the dotted line. Curve A in Fig. 2 is for a poor transformer, while curve B is for a good modern example. The falling off at low frequencies in A is due to insufficient inductance so that the impedance of the circuit at low frequencies becomes comparable with the valve internal resistance; and, to a smaller extent, by copper and iron losses in the transformer itself. The falling away at the upper frequencies is due to the self-capacity of

the transformer secondary winding and to leakage between the windings.

The leakage between windings refers to the amount of magnetic flux produced by the primary which is not absorbed in the secondary winding in giving a step-up in voltage. By careful design of the shape and size of the core and windings, and by the relation of the primary and secondary windings to one another, this leakage can be made quite small. It will usually be less than one per cent. in a good transformer provided that the ratio of secondary and primary turns is not too great, as when it becomes large it is very difficult to arrange the two windings so that there is little leakage. Furthermore, if the amount of wire on the transformer can be reduced both the self-capacity and the amount of leakage can both be reduced at the same time. When speaking of leakage and self-capacity, we may refer to the hump C on the curve B, which is a direct manifestation of the presence of both these undesirable features.

The leakage inductance referred to has been shown to behave as a small inductance joined in series with the secondary winding, and the self-capacity can be regarded as a fixed condenser joined across the secondary winding, together with the effective input capacity to the valve, a point which should not

improved characteristic, combined with a very useful reduction in size and weight.

Diverting the D.C.

With regard to the performance characteristics which we have just discussed, so far so good, but we only get these improvements if we use the transformer in the right way, and that is where the main snag arises. If we look again at the curves of Fig. 1 we see that the quantity along the horizontal axis is marked "magnetising force," and that the permeability, and therefore the inductance, varies with this magnetising force. The size of this force is determined by the current in the transformer and the number of turns of the winding. It is usually expressed in units named after Gauss, a pioneer worker in magnetism, and is given by $\frac{4\pi}{10} \times$ ampere turns in the winding.

Then, for a transformer having a given number of turns the inductance will vary with the current flowing through it. Furthermore, in an amplifier there is the steady plate current flowing through the windings on which the voice-frequency alternating currents are superposed. This steady plate current flowing through the primary winding will produce such a large magnetising force that the value of the permeability will fall to something very much lower than would have otherwise been the case, and may, in fact, be lower than that if ordinary soft iron were used.

The graph of Fig. 1 only shows the value when this magnetising force is quite small, but even at the greatest value shown there (i.e., 0.5) it is evident that the permeability of the alloys is falling fast, while that for iron is going up steadily. If we had 5 milliamps.

flowing through a 2,500-turn primary there would be a magnetising force of 10 units, at which value we should find that the iron alone was definitely superior to the alloys. It is, therefore, very evident that if these alloy-cored transformers are to be used with any success in the plate circuits of valves, some means of diverting the steady plate current from the transformer windings must be found. Fortunately, this is not difficult, and the circuit of Fig. 3 gives the solution. Here we have virtually a resistance-capacity coupling with a transformer to step up the voltage at the point where it is normally applied to a high leak resistance between the grid and filament of the ensuing valve.

This circuit will be quite familiar to most readers, although the reasons lying behind its adoption may not have been so obvious. We will not discuss the choice of values of R and C, as this has been

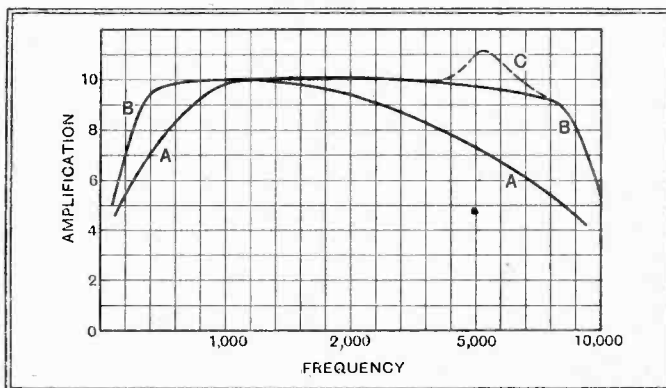

Fig. 2.—Amplification-frequency curves of two modern transformers. The drop at low frequencies is due to insufficient inductance, whilst the rise at C is accounted for by leakage inductance.

be forgotten. We thus have a parallel resonant circuit with small damping which, with the values usually occurring, resonates somewhere in the neighbourhood of 5,000 cycles; so that just as the amplification is dropping off this resonant circuit comes into the picture and raises it to something greater than it was previously. If it merely corrected for the fall so much the better, but usually it produces a pronounced effect over a narrow band of frequencies, and then the amplification falls off more rapidly than before. Considering these effects in the case of the transformer with the nickel-iron core, it is possible to obtain the necessary inductance to keep the amplification up at low frequencies by using much less wire than formerly, so that we therefore have less self-capacity than before and can more easily arrange that there is less leakage.

Thus, in one fell swoop several difficulties are solved, and we have a much-

The Story of the Small L.F. Transformer—

fully dealt with in previous articles (see article by Aughtie and Cope, *The Wireless World*, December 11th, 1929), and results are given enabling one to select the appropriate values for any given combination of valve impedances, primary inductance, and the lowest frequency to be fully amplified. There is, however, one point about the circuit which is new, and that is the resistance R1 connected across the coupling condenser. This is not a short-circuit on the H.T. battery, as might be supposed, as its value is high, of the order of a megohm. The reason for its use lies in the shape of the curve connecting permeability with magnetising force. Fig. 1 shows that when the magnetising force is nothing, or very small, the permeability is less than it is for slightly greater values of the magnetising force. Also the permeability is not proportional to the current in a simple way, that is to say, the graph connecting them is not a straight line.

By passing a very small direct current from the H.T. battery through the winding it will be possible to shift the point at which the transformer operates on to that part of the graph where it is straight and at the same time take advantage of the increased value of permeability at that point. No definite value can be assigned to R1 as it depends upon the value of H.T. and the core. About 1 to 2 megohms should be suitable in a large number of cases.

In order to show further what serious effects the presence of direct current may have on these alloy-cored transformers Fig. 4 shows some primary-inductance measurements made on both types when direct current was passing through the windings. It will be seen that in the case of soft iron there is actually a small improvement up to a certain value of current, after which the inductance falls slowly at first and later more rapidly.

The Resonance Effect

It may be remarked in passing, and the argument will be obvious from the graph, that little or no improvement in quality will be obtained by using resistance-capacity coupling with an iron-cored transformer. If any improvement in bass response is obtained it will be due to a resonance effect between the primary inductance and the coupling condenser. If such an effect is desired the value of the coupling condenser should be chosen to resonate the windings somewhat lower than the lowest frequency which it is

desired to produce. Furthermore, it is possible that in powerful amplifiers this method will lead to distortion in the form of harmonic frequencies produced, because the relation between the inductance and the magnetising force is not linear, but this is a point to be discussed later. Returning to the curves on Fig. 4, it will be seen

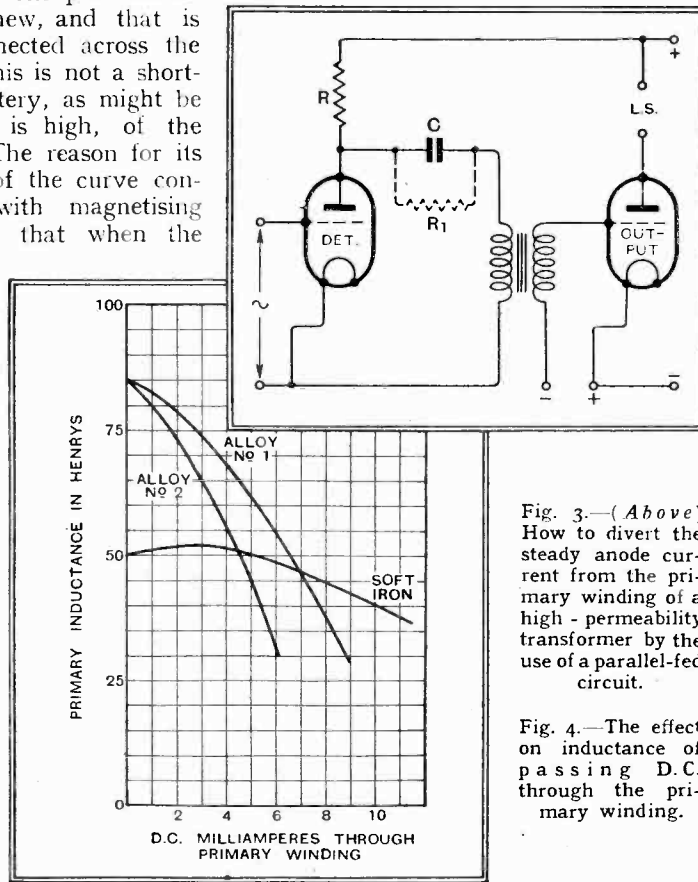

Fig. 3.—(Above) How to divert the steady anode current from the primary winding of a high-permeability transformer by the use of a parallel-fed circuit.

Fig. 4.—The effect on inductance of passing D.C. through the primary winding.

that in the case of the alloys the inductance falls very rapidly indeed as the current exceeds a value lying somewhere between zero and two milliamps. As detecting and amplifying valves seldom operate with plate currents as low as this, it will be necessary in almost every case to send the plate circuit by some different path. If this were not done the advantage of the special core would soon be lost, and might easily become a disadvantage, as the curves show.

In most cases the passing of too much direct current through the windings does no permanent harm to the core, although it is not to be recommended. However, it will be found that any slight changes brought about by an excess of such treatment can be nullified by demagnetisation. This is not an erudite laboratory process, but merely consists in passing a few milliamps. of alternating current from the 50-cycle mains through the transformer windings for a few moments. If the primary inductance is high a connection across the 200-volt mains will usually give about the right current. It is preferable to include a safety lamp in series in case of accidents.

The overloading of intervalve transformers is not a question that is often referred to, but it must be remembered that it can take place and may spoil the

reproduction of very high-quality apparatus. When the plate current varies in sympathy with the voice-frequency grid-voltage variations the magnetism in the transformer varies in the same way in order to produce a corresponding copy in the voltage on the secondary winding. These variations take place over a characteristic shaped rather like that of an ordinary triode, and the slope of this characteristic is the permeability which has been the main consideration in the properties of these transformers. Thus, if the current variations are too large they will extend beyond the straight part of the characteristic and distortion will be produced.

Fortunately, unless the overloading is very excessive the results are not serious, not, in any case, as serious as similar occurrences in valves. It is, however, a point to be borne in mind in amplifiers handling very considerable power, where the voltage in the plate circuit of the valve preceding the output stage may be considerable. This effect is not confined to nickel-iron cores; it can equally well occur in a soft-iron-cored transformer, particularly if this is rather heavily loaded with direct current, which will tend to bias the working point away from the centre of the characteristic towards one of the curved extremities.

The nickel-iron-alloy-cored transformer is a definite advance in the design of compact and popular-priced apparatus, and is already extensively used. The properties of high-permeability and low losses which have been discussed give an ideal solution to the problem of uniform performance and are finding application in very many branches of the communication field. At present, while valves have to pass a direct current which is many times greater than the signal variation in the current, it will be necessary to adopt the special measures in order to get the best results.

BOOKS RECEIVED

Photograms of the Year 1932. Edited by F. J. Mortimer, Hon. F.R.P.S.—The 38th issue of this popular annual contains nearly one hundred beautiful reproductions of pictorial photographic work from all parts of the world, with critical notes on many of the pictures. The editorial article deals fully with the year's work in photography, and there is, as in previous issues, an up-to-date Directory of Photographic Societies. Published by Iliffe and Sons Ltd. Price 5s. in paper covers, 7s. 6d. cloth bound, or 10s. 6d. half-bound leather, postage 6d. extra.

Photography Made Easy (3rd edition), by R. Child Bayley.—A book intended primarily for photographic beginners which starts with the assumption that the reader has no previous knowledge of the subject and gives in plain language a mass of useful instruction on apparatus and materials, choice and arrangement of subject, copying, enlarging, making lantern slides, etc., with advice to the novice on what to avoid. Pp. 251+viii. Published by Iliffe and Sons Ltd., London. Price 2s.

Théorie et Pratique de la Télévision. by E. Aisberg and R. Aschen.—Comprising the theory and progress of television with brief descriptions of the various systems and practical instruction to amateurs wishing to construct their own televisions. Pp. 236 with 216 diagrams and illustrations. Published by Etienne Chiron, Paris. Price 30 francs.

The ALL-WAVE MONODIAL SUPER

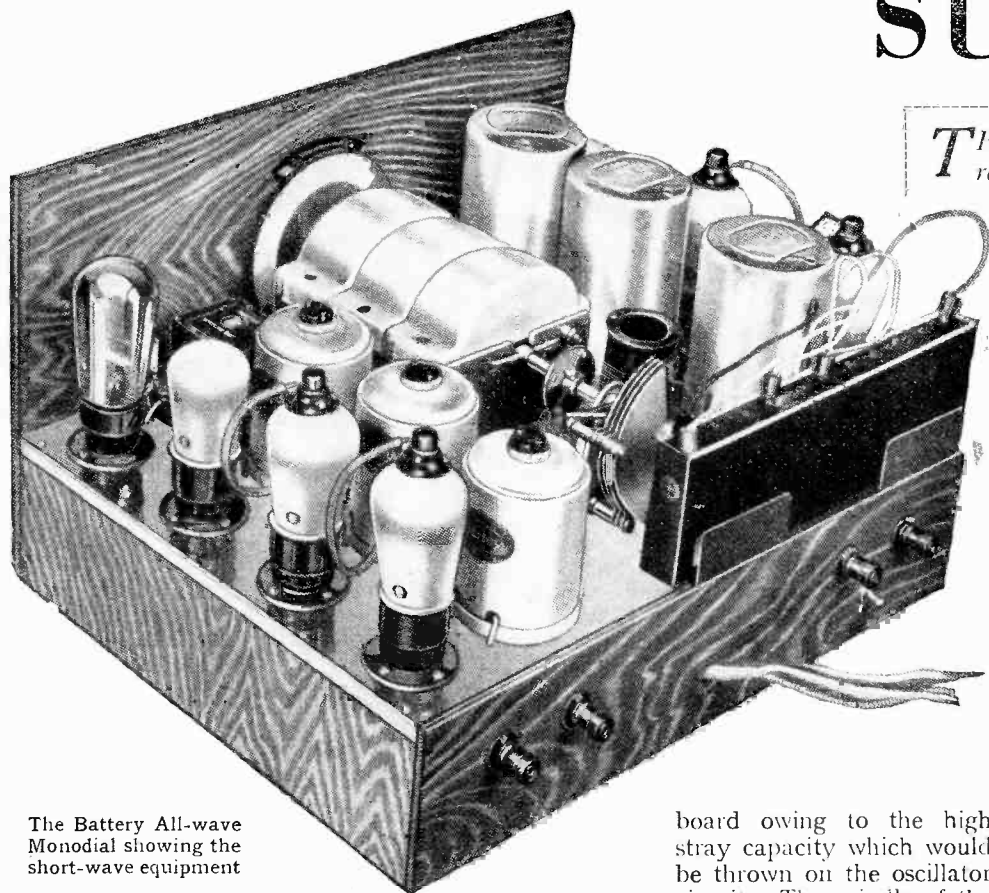

The Battery All-wave Monodial showing the short-wave equipment

THE popularity of the Monodial series of receivers has become so great that, in presenting the first battery model, it has been thought advisable to extend its utility by including the short wavelengths within the tuning range. In the issue dated January 27th appeared a discussion of the theoretical circuit, and the constructional details and operating notes are given in the present article.

Constructional Details of the New Battery Superheterodyne Tuning from 12.26 to 2,000 Metres

By W. T. COCKING

(Concluded from page 63, January 27th issue)

IN spite of the apparent complexity of the circuit diagram, reproduced in the earlier instalment, the receiver is essentially simple, and its construction is little more complicated than that of any normal type of superheterodyne. The apparatus is all assembled on a metal-covered chassis measuring 16in. by 12in., and supported on battens 3in. deep. This chassis may be obtained ready drilled, but if plain material be employed it will be necessary to drill eight one-inch diameter holes for the valve-holders and coil socket. As the aluminium covering to the plywood is quite thin, an ordinary centret-bit is satisfactory for this work.

The short-wave switches are obtainable as a ganged assembly, and can be screwed directly on to the under-side of the baseboard. As the terminals are not all readily accessible when it is in position, however, it is advisable in certain cases to attach the connecting wires before mounting it. The normal waveband coils, it should be noted, are supplied with shallow trays for spacing the screens from the baseboard. These trays should be inverted so that the bottoms of the coil cans are raised sufficiently to bring the switch spindle level with the on-off switch.

The compression condenser C₄ in the oscillator circuit is raised about 1/8in. above the baseboard by means of washers inserted under the fixing screws. It is important not to omit this precaution, as correct ganging will be possible if the condenser be screwed directly on the base-

board owing to the high stray capacity which would be thrown on the oscillator circuit. The spindle of the S.W. condenser should be lined up with that of the gang condenser as accurately as possible, in order to reduce the strain on the flexible coupling unit.

The wiring is carried out with No. 22 tinned copper wire run in insulating sleeving, except in a few cases where screened leads are employed. The screened wire should not be of the heavily rubber-covered type, but should rather consist of large diameter sleeving with a braided metal covering, through which a length of

No. 22 wire can be inserted. The covering, of course, must be earthed at the points indicated in the diagrams, and care should be taken to see that the ends of the braiding do not fray and come into contact with the inner wire.

Checking the Voltages

It is recommended that the accumulator for the L.T. supply should have a capacity of 30 a.h. or more, since there is a drain of 1.15 amperes on it, and the 100 volts H.T. battery should be of the type rated for discharge at 16 mA. in order that economical working may be obtained. No

deviations from the specified valves should be made other than to the alternatives given in the list of parts.

In order to check the operation it is wise to make sure that the various currents and voltages are in approximate agreement with the figures given in the table. It should be noted that these were taken with the volume control so set that the receiver was just not oscillating. Consequently, it is to be expected that the currents of the H.F. and first I.F.

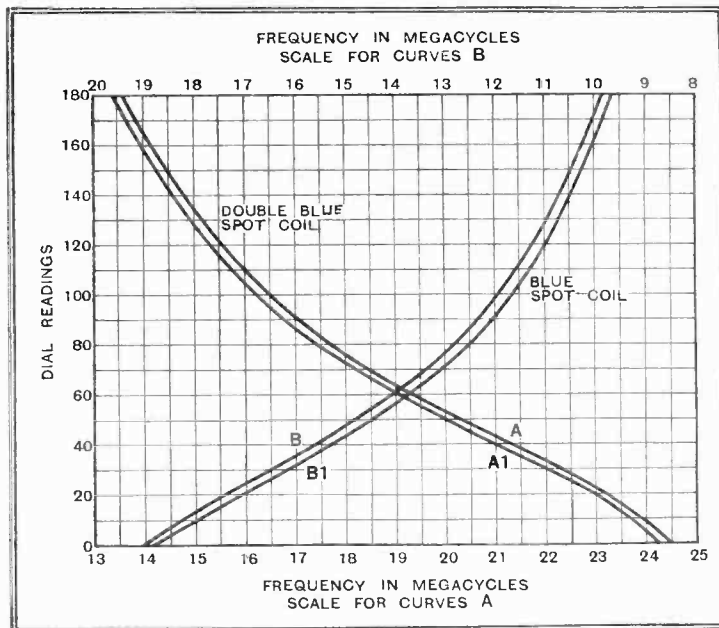

Calibration curves for 10 to 19 and 19 to 24 megacycles.

The All-wave Monodial Super—

valves may differ somewhat in different sets. The first step in adjusting the receiver is to set the coils in each I.F. transformer at nearly their maximum distance apart,

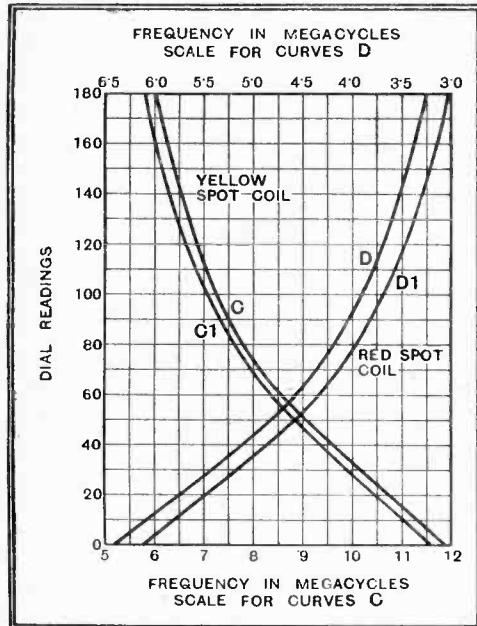

The ranges from 3 to 6½, and 6 to 11½ megacycles, are given in this figure.

and to replace the screening covers. A signal should then be tuned in, and the trimmers on each transformer adjusted for the maximum response. While doing this care should be taken to keep the signal very weak, by turning down the volume control, so that false results are not obtained through detector overloading.

The ganging on the medium waveband

comes next, and the switch in the screened coil assembly should be set for this range, and the S.W. switch set for reception on the normal wavebands; the local-distance switch should be set to Distance. A S.W. coil must be in its socket, of course, otherwise the anode circuit of the first detector would not be complete. The two trimmers on the pre-selector circuits, C1 and C2, should be practically fully unscrewed, and the oscillator trimmer unscrewed by about two complete turns. A station on as low a wavelength as possible must then be tuned in, and the two pre-selector trimmers adjusted for maximum response.

Should it be found that either trimmer has to be fully screwed home the oscillator capacity is too great, and the trimmer on this circuit must be unscrewed further. On the other hand, if it be found that the intervalve circuit trimmer C2 is fully unscrewed then the oscillator trimmer should be screwed up a little more tightly, and the ganging process repeated. The final result should be such that neither C1

nor C2 is fully screwed home nor fully unscrewed, but it should be noted that C2 will usually be very nearly at its minimum capacity.

Should it be found that the aerial circuit trimmer C1 has to be fully unscrewed, the cause is an aerial of high capacity. This does not necessarily mean a large aerial, for indoor aeriels have often a higher

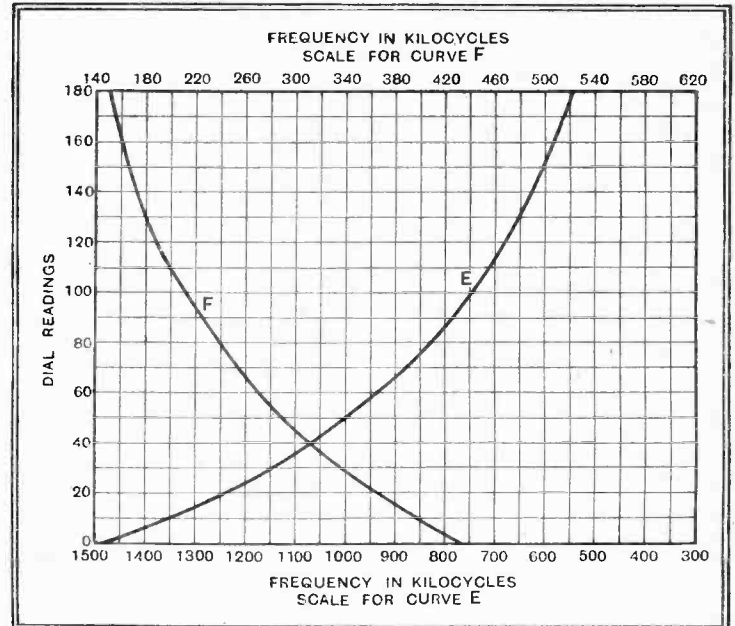

These curves show the dial settings for the 550 to 1,500 and 150 to 430 kilocycles ranges.

capacity than efficient outdoor types. In these circumstances the size of the aerial can be reduced, or, more simply, a suitable value fixed condenser can be inserted in series with it. The best value of condenser should be found by trial, but some 0.0005 mfd. to 0.0002 mfd. will usually be the best; at very short distances from a local station, however, a somewhat smaller capacity may be found preferable.

The Long Waveband

Having settled points of this nature, and obtained correct ganging at the lower end of the medium waveband, the next step is to tune in a station on about 500 metres, and to adjust the oscillator trimmer while rocking the tuning dial backwards and forwards over a few degrees, until the optimum combination of settings be found. It is then necessary to return to the lower wavelength station, and to readjust the two pre-selector trimmers.

The long waveband is then due to receive attention, and an attempt should be made to tune in a station such as Huizen or Radio-Paris with the padding condenser C4 adjusted to about one-half of its capacity. Having found a station, C4 must be adjusted while rocking the tuning dial backwards and forwards until the optimum combination of settings is found.

The couplings of the coils in the I.F. transformers must now be adjusted to give the best compromise between selectivity and quality. In general, the coils in the third transformer can be set to a point slightly closer than that giving optimum

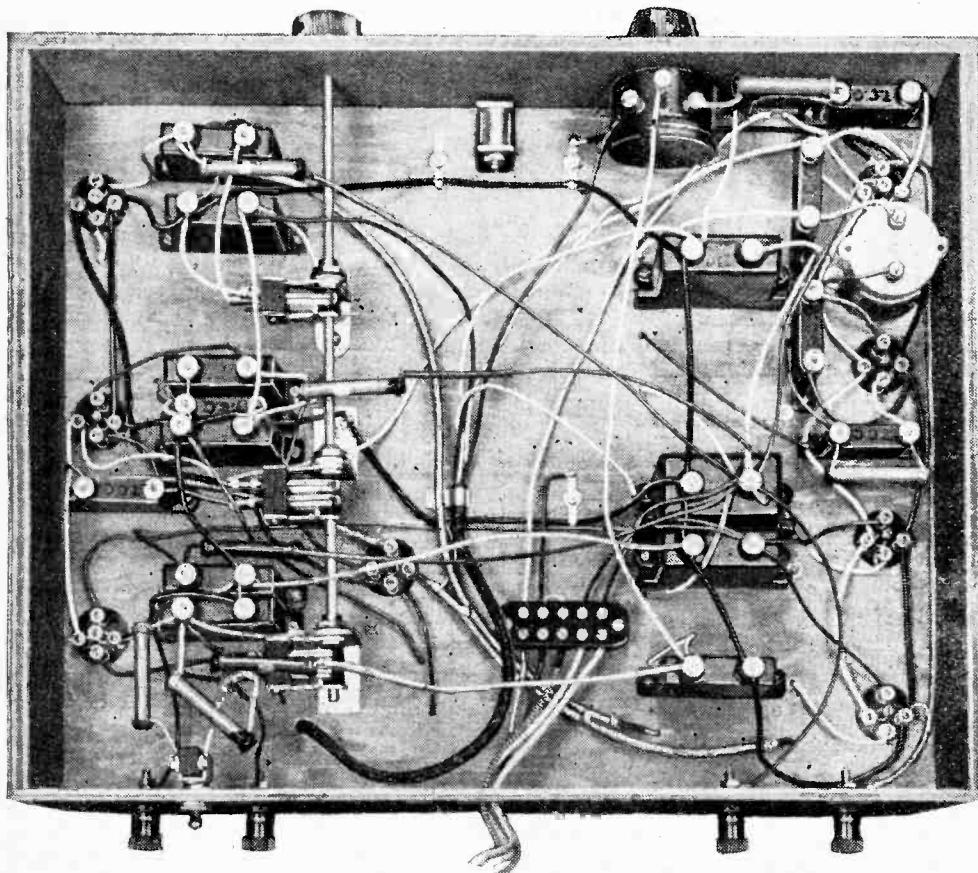

Under-baseboard view of the receiver, showing the short-wave change-over switch.

The All-wave Monodial Super— signal strength; owing to the damping imposed by the second detector, they will then be nearly touching. The coils in the first transformer should normally be set for optimum signal strength, and these will be well separated, while the coils in the second transformer must be fixed at the point giving the best quality. This setting will usually be about midway between the settings adopted in the first and third transformers, but it will depend largely upon the loud speaker used.

It should now be found that the receiver operates satisfactorily over the whole of the two normal wavebands; the sensitivity should be adequate for the reception of the weakest stations, and the selectivity should be such that all stations spaced by 9 kc. can be separated, except perhaps those immediately adjacent to a powerful local. The quality should be good, but too much volume should not be expected in view of

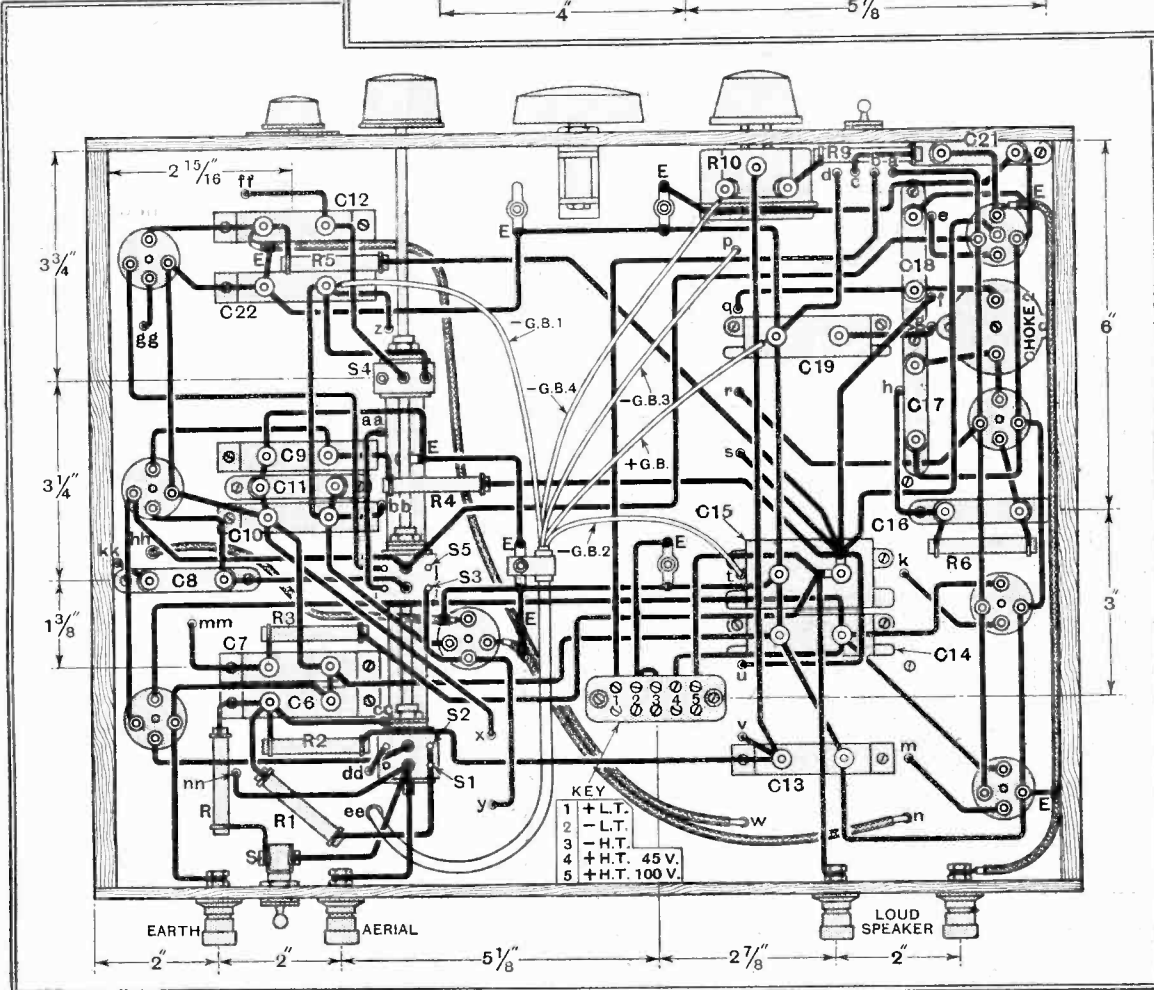
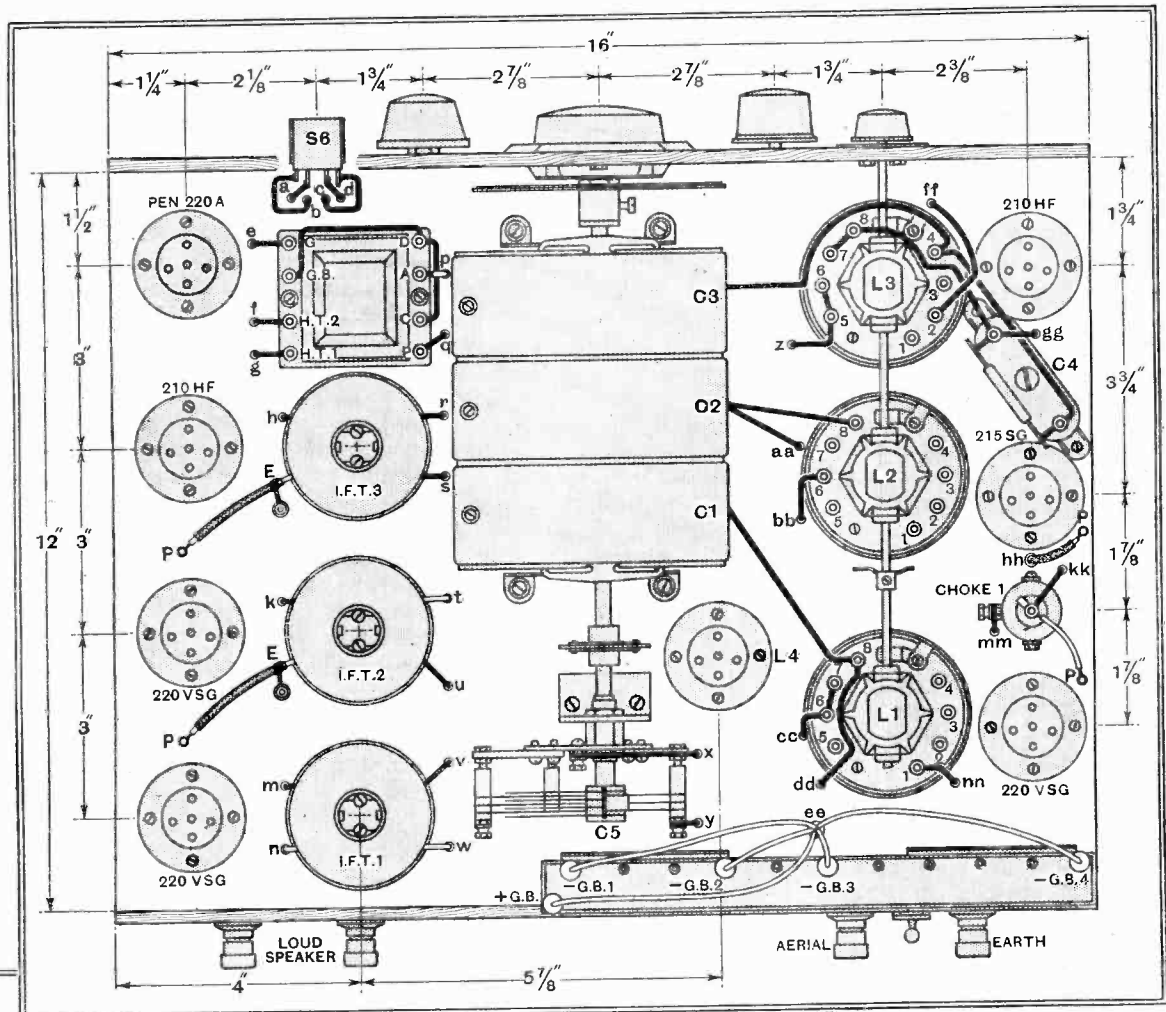

The practical wiring diagrams, showing also the principal measurements.

the low total anode current consumption.

On the short wavelengths there are no preliminary adjustments, and reception on one of the four bands available should be obtained immediately on operating the S.W. switch. In general, when receiving on short waves, the switch in the screened coil assembly should be set for the medium waveband, but in many cases it will not affect the results.

The tuning procedure on the short waves is rather different from that on the normal bands, for the volume control should normally be turned up so that the I.F. amplifier is oscillating. This state can be detected by the appearance of a rushing sound. The tuning dial should then be rotated slowly, for in spite of the 22-1 reduction ratio, quite a small movement of the control knob is sufficient to pass through a station on the short wavelengths. When a station is tuned in, the familiar heterodyne whistle will be heard, and the volume control can then

The All-wave Monodial Super—
be reduced until the amplifier stops oscillating.

Too much should not be expected at first on these wavebands, for atmospheric conditions are very variable, and change so rapidly and to such a great extent that periods when little can be received are by no means uncommon. Good reception in this country of the new British S.W. stations is hardly to be expected, and the band around 30 metres (10 megacycles) is probably the best to try at first, for it contains a number of strong morse stations.

It will be found that conditions vary throughout the wavebands at different times of the day, and it has been the writer's experience that wavelengths below 25 metres (12 megacycles) are of little use

For the convenience of readers constructing this receiver, full-size blue prints are available from the publishers at 1/6 post free.

after dark. Daylight usually gives the best conditions below 20 metres (15 megacycles), but sunset seems to be the best time for wavelengths just around 20 metres. The higher wavelengths are much less affected, and it is common to find that on the 50 metre-band results are equally good day and night.

When operating this set on the short waves, it will be found that every station can be tuned in at two distinct settings of the dial. This is due to the use of an autodyne type frequency changer without signal frequency tuned circuits, and it does not lead to interference owing to the small number of stations operating on these wavelengths. Should second channel interference be found at any time, however, it can be avoided by changing to the other dial setting.

One other point in connection with the S.W. performance is worthy of mention.

TABLE.

| Valve. | Anode Volts. | Screen Volts. | Bias Volts. | Anode and Screen Currents (Total). |
|--|--------------|---------------|-------------|------------------------------------|
| Output : Pen. 220 A | 100 | 100 | -9.4 | m.A. 4.5 |
| 2nd Det. 210 HF | — | — | — | 1 |
| 2nd I.F. 220 VSG | 100 | 45 | -4.6 | 0.65 |
| 1st I.F. 220 VSG | 100 | 45 | — | 1.2 |
| Osc. 210 HF and 1st Det. 215 SG | — | — | -1.5 | 3.5 |
| H.F. 220 VSG | 100 | 45 | — | 1.8 |
| Total Current | | | | 12.65 |

Voltages left blank above are not accurately measurable with ordinary instruments.

When receiving a strong station, it may be found that there is a tendency for a low-frequency howl to develop. This is a common occurrence in S.W. sets, and is due to acoustic reaction from the loud

speaker to the set. The valves may be partly responsible, but little difference has been observed between different types, and there is no doubt that it is chiefly due to the plates of the variable condenser vibrating in sympathy with the sound output of the loud speaker. The remedy is to mount the chassis on blocks of sponge rubber, so that it floats freely.

The receiver has been tested at about nine miles from Brookmans Park, and under these conditions it was found desirable to restrict the signal input somewhat by using a fairly small aerial. Owing to the high sensitivity, however, this did not reduce the number of stations obtainable, and all stations separated by 9 kc. or more from their neighbours were obtainable free from interference. The two usual points of second channel interference from the two London stations were found, but in spite of the close proximity to the locals, no undesired responses were found on the short wavebands. Tuning on all ranges is easy and definite; the shorter the wavelength, however, the sharper it appears,

due to the increased frequency range covered by a given movement of the condenser dial.

On all ranges the quality reaches an equally high standard, provided that the volume is kept below the overloading point. The volume obtainable is naturally limited by the output valve, but is surprisingly large for the power consumed from the H.T. battery. In cases where current consumption is of little importance, as when H.T. accumulators are used, the anode voltage of the second detector and the pentode may be raised to 150 volts with advantage, but no more than 100 volts should be applied to the earlier valves. The calibration curves which accompany this article will be found of great help in locating stations, particularly on the short wave ranges, but it must not be expected that the settings for any particular receiver will exactly correspond.

A specimen receiver built to this design is available for inspection at 116-117, Fleet Street, London, E.C.4.

DISTANT RECEPTION NOTES

A GOOD many of those who indulge in the fascinating pastime of sitting up for America find little difficulty in identifying stations with certainty. Though by law the call-sign must be given every quarter of an hour (except when the continuity of an item would be ruined by so doing), it happens more often than not if there is any fading about a minimum period coincides with the opening of the announcer's lips.

Identification is made very much easier if the classification of stations likely to be heard in this country is known. American stations fall into three main groups: the National Broadcasting Corporation's (N.B.C.), the Columbia chains, and the Independent stations.

Here are some of the best heard stations arranged in their groups:—

| N.B.C. | Columbia. | Independent. |
|--------|-----------|--------------|
| WGY | KMOX | WKAQ |
| WENR | WPG | WJSV |
| KDKA | WJJD | |
| WBZ | WCAU | |
| WTIC | KFJF | |
| WTAM | | |
| WHAM | | |
| WIOD | | |

Once you have identified any station in either of the two big groups and made a note of its settings, identification of other stations giving the same programme becomes much easier. Again, stations not sending one or other of the S.B. programmes can often be identified, if the approximate wavelength to which the set is tuned is known, by the very fact that they are Independent.

Long-distance enthusiasts may have noticed a considerable increase in the strength of Ljubljana (generally known as Dubblejana), the Yugoslavian station on 574.7 metres. For some little time now this station has been giving more than double the output power shown against its name in the lists.

Some of those who ardently desire to add the Vienna Experimental Station (1,250

metres) to their logs have searched for it in vain and wonder whether it really is at work. It is nearly always in operation on Monday and Saturday evenings, and not infrequently on Wednesdays. The only real difficulty about receiving the station is that it is apt to be heterodyned by Boden on the one side and Baku on the other.

The new Madona station in Latvia has been in operation for some time now, but it is exceeding difficult to log owing to the fact that it is working on the well-occupied common-wave of 453.2 metres. Madona is a 10-kilowatt station, and the best chance of hearing it comparatively free from interference is to make a search just at dusk when the smaller fry which share the wavelength are not so much in evidence.

The 2.5-kilowatt Belgrade on 430.4 metres was fairly well heard during the autumn of 1932, but just now it is only occasionally that good reception is possible. We should, though, hear Belgrade well before the end of this year, for a new station rated at 50 kilowatts is being constructed.

Long-distance conditions are very good just now, especially when the glass is steady. If it is rising or falling rapidly atmospherics, though luckily not of the more violent kind, are sometimes experienced. Huizen on the long waves is in magnificent form, being almost as strong as Radio-Paris. Zeesen is well heard, and Motala has quite returned to strength. Kalundborg, curiously enough, is received best on days and nights when conditions are not too good. When they are good this station is apt to suffer from a heterodyne from the far-away Tashkent. The latter station is geographically more than 2,000 miles from the former, but the frequency separation is only 3.6 kcs.

Of the medium-wave stations Stockholm and Katowice continue to be first-rate, and others which seldom fail to give splendid reception are Prague, Florence, Budapest, Vienna, Munich, Brussels No. 1 and No. 2, Langenberg, Rome, Leipzig, Strasbourg, Poste Parisien, Göteborg, Turin, and Trieste.

D. EXER.

NEWS of the WEEK

No Listening "On Tick"

THE Postmaster-General has decided that he cannot allow wireless licence fees to be paid by instalments or by any easy payment system.

Exit the Coach Horn

FRENCH listeners are already growing tired of the new coach horn interval signal of *Poste Parisien*, and the station may shortly abandon it in favour of a few bars of patriotic music.

Flying Commentaries

THE Soviet broadcasting authorities have secured six 'planes equipped with short-wave transmitters to enable running commentators to give the listening millions aerial accounts of exciting land, sea and air happenings.

A Terpsichorean Technician

MADMOISELLE TIMISCHOVA, a young Rumanian dancer, has been studying the electron theory, and, according to a correspondent, has recorded her impressions in a booklet entitled "Problems of the Ectogeneity and Endogeneity of the Rhythms of Matter."

The Eye of the Law

WHILE American amateurs are rejoicing in their new-found freedom, their cousins in France are watching apprehensively a new official Order which places all transmitting activities under the control of the Home Office Detective Department, which, incidentally, directs the new national radio police force.

Air Ministry Non-Stop Flight to the Cape

AS we go to press we learn of the departure from Cranwell of the long-range aircraft GEZAA on the Air Ministry non-stop flight to the Cape. The 'plane transmits every two hours at even hours on a wavelength of 33.71 metres, using the call sign GEZAA. Any amateur who happens to pick up a distress call from the 'plane is requested to communicate with the Air Ministry immediately either by telephone (Holborn 3434, Extension 383 or 370) or by telegram.

Broadcasting Electrical Music

THE evening of February 16th will be a great occasion in the history of "electrical music." A number of German stations, together with those at Warsaw, Vienna, Turin and Milan, Paris and Brussels, Oslo, Stockholm, and Helsingfors, will relay a concert from Berlin provided solely by electrical instruments. These will comprise two Neo-Bechstein pianos, three Trautoniums, one electrically played 'cello, and a similar type of violin, together with two Theremin instruments, an "electrochord" (a modification of the Neo-Bechstein) and a vibraphone.

Current Events in Brief Review

Japanese Radio Ban

AN order has been issued by the Tokio Government forbidding Japanese subjects to listen to wireless programmes other than those from Government stations. The step has been taken, it is understood, to neutralise alleged propaganda broadcast by the Soviet.

Automatic Gramophones

IN the article on the "Evolution of the Gramophone" which appeared in *The Wireless World* last week, the author, owing to the similarity between the names of two members of the staff of the H.M.V. Research Laboratories,

When Doctors Differ

WHETHER or not radio echoes are reflected from beyond the moon was debated recently by Professor Störmer and Dr. Van der Pol during a special visit of the former to the Philips Radio Works at Eindhoven, Holland. Prof. Störmer's theory is that radio signals travel far beyond the moon before being reflected to earth as echoes. On the other hand, Dr. Van der Pol explains the echo lag by the low signal velocity which he considers may occur in the electrified parts of the earth's atmosphere while the signals travel between the earth and the Heavily Layer.

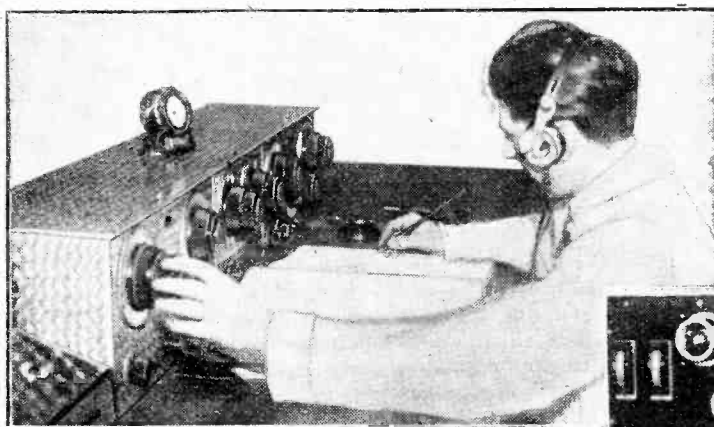

NATIONAL POLICE RADIO. In these photographs, which were taken at the Paris headquarters of the French Police radio system, are seen (above) an operator receiving a message from a mobile transmitter and (right) the new apparatus for the transmission of photographs and thumbprints.

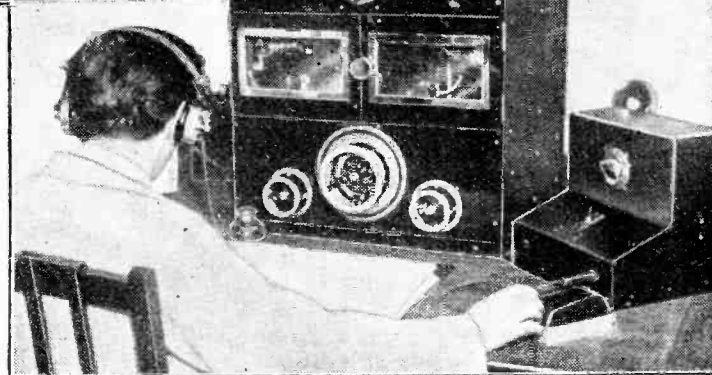

Wireless for the Unemployed

THE secretary of the Halifax Wireless Society sends an interesting account of a scheme which has been successfully launched in that town for providing unemployed men with wireless facilities.

"After a certain amount of publicity," he writes, "meetings of unemployed men were held and about eighty were enrolled. We begged old parts and old sets, certain kindly disposed people gave us a little money. . . . The men are now able to enjoy wireless programmes round a good fire.

"They are also working in teams on the construction of simple two- and three-valve receiving sets. All the men being novices, their efforts are, of course, somewhat crude, but the sets will work."

Other towns might copy Halifax and bring comparative contentment to the unemployed at low cost.

Leicestershire Radio Week

A LEICESTERSHIRE Radio Week begins on February 27th. During the "week" industrial activities of the country will be prominently featured in the B.B.C. programmes. A number of interesting outside broadcasts have been arranged.

From D.C. to A.C.

THE battle which has been raging for more than a year between the Fleetwood Council and the local ratepayers' association has reached another stage with the receipt by the association of an encouraging letter from the Electricity Commissioners. The Fleetwood Council had declined to contribute to the cost of changes necessary in wireless receivers consequent upon the change-over in the supply from D.C. to A.C.

The Electricity Commissioners state that they "are advised that under the terms and conditions of their consent to the alteration in pressure and supply the undertakers (in this case the Fleetwood Council) cannot, speaking generally, disclaim all responsibility for the alteration or replacement of wireless apparatus."

Should the Fleetwood Council

refuse to change its attitude the ratepayers may go to the Courts.

Southend Radio Show

AN amateur-built seven-valve receiver, comprising variable-mu high frequency, diode detector and paraphase resistance-coupled low frequency, won for Mr. A. H. Gregson the silver championship cup for the outstanding constructional exhibit at the Southend Radio Society's Exhibition on Saturday, January 28th. The exhibition, which worthily upheld the traditions of its eight predecessors, was attended by large crowds, who besieged both the trade and amateur sections. In the latter two transmitters—one of the ultra short-wave type—were included, as well as a number of up-to-date receivers and amplifiers. Music was supplied to all the stands in the trade hall by an amplifier built by the Society's chairman, Mr. H. H. Burrows, and giving an output of 18 watts.

UNBIASED

Thawing by Short Wave

DURING the recent cold snap a respectable newspaper came out with a long tale of a wonderful short-wave transmitter invented by a well-known wireless amateur whereby he was not only able to thaw out his own water pipes, but had done a like service for his unfortunate neighbours. Sensational headlines such as "Short waves cause ice to boil" appeared.

It is only right, I think, to point out that I, together with many others, have used for a number of years a very simple



short-wave transmitter to thaw our pipes; the wavelength we invariably employ is round about 1/10,000,000 metres.

Phonographic Pick-up, Please

MOST people would expect to find that at a hospital devoted to the alleviation of nervous diseases there existed radio and other musical apparatus of the very latest type to sooth the jangled nerves of the occupants. I had occasion to visit one of these establishments a short time ago and was considerably astonished to see a wireless set and loud speaker which dated back to 1922. Actually the installation had been put in early in 1923.

In reply to my suggestion that the appalling travesty of music churned out by such a collection of junk would tend to retard rather than hasten the recovery of the patients, the matron pointed out that more often than not the installation was left standing idle at the special request of the patients. This, at any rate, showed a healthy state of mind among the patients and augured well for their recovery.

While the matron showed very little interest in modern radio reproduction, she brightened up considerably when I talked about gramophone records and asked if I could get her one of those "new-fangled" electrical pick-ups so that canned music could be distributed to the patients' headphones from a "talking machine" (*sic*) which an old patient had left to the hospital as a legacy.

By

FREE GRID

Having readily promised to do so, I was greatly disconcerted to discover that it was a cylinder machine dating back to the early years of the century. I appealed to her to persuade the hospital governors to start a radio-gramophone fund, but all in vain; thus I am left to redeem my rash promise. If, therefore, any kind-hearted reader can tell me where to obtain a pick-up suitable for a cylinder machine with the usual "hill and dale" recording I shall be infernally grateful.

Of the Earth, Earthy

NUMBERS of readers have from time to time written to voice a strong protest, with which I completely associate myself, at the superior attitude adopted by amateur transmitters and experimenters towards those "worms-of-earth," their less technical brethren. In particular, I wish to take exception to the term B.C.L. (broadcast listener) which they apply to all outside their immediate circle. It is really not the expression itself which gets my goat, but the way in which they use it. The expression may be a perfectly proper one, but if you have ever heard it used by a member of "the fraternity" you would, I think, understand my objection to it.

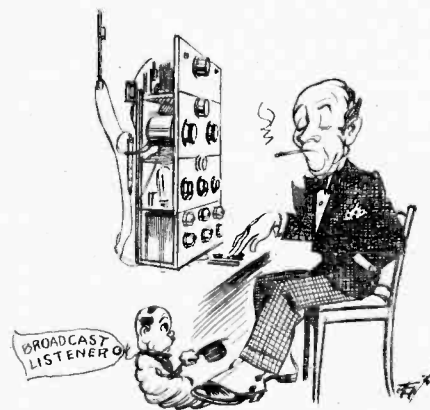

As one of the earliest transmitters myself, I feel that it is befitting that this gentle protest should come from me. At the same time, I fully realise that the pukka amateur has a perfectly legitimate right to puff out his chest somewhat, especially as much kudos which should by right accrue to him has been appropriated by radio manufacturers and official departments. Perhaps it is because of indignities suffered at the hands of these others that transmitters are led to adopt such a condescending air towards their so-called humbler brethren.

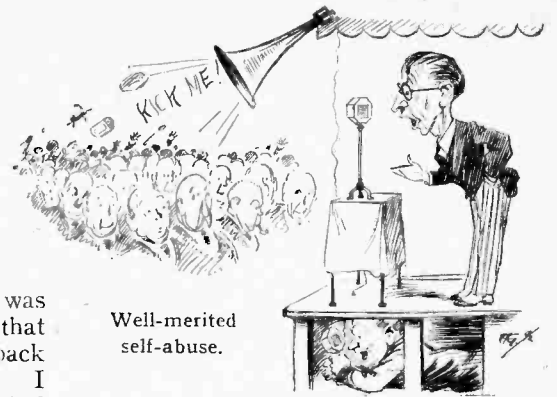

The Voice Off

HAVING been brought up very strictly in my youth and, in consequence, being somewhat of a stickler for the truth, I have little use for politicians. Usually I have found them, like certain "engineers" on duty at Olympia, full of gas, but incapable of answering any reasonable technical question.

I am not in the least sorry, therefore, at a misfortune which befell one of them recently at an election meeting in a neighbouring friendly State.

According to my informant, the meeting was held in a large marquee, and, as it was virtually impossible for any but those in the first two or three rows to hear the orator, loud speakers were provided. Not even the orator's bitterest enemy, however, could have anticipated the volley of well-merited self-abuse which issued from the loud speakers as soon as he had started to address the microphone. Those at the rear of the hall were not slow in responding to his invitation to pelt him with the flora and fauna that is customary on these occasions. In a twinkling of the eye the whole place was in an uproar, but not before my friend, who is an expert lip reader, had noticed that the words emanating from the loud speaker were not those being used by the candidate.

Eventually, after the meeting had been successfully broken up, it was revealed that the trouble was caused by a member of the opposition camp, who had hidden himself beneath the platform among the amplifiers and batteries and had merely disconnected the speaker's microphone and plugged in his own.

For His Country's Good

I AM compelled for business reasons to desert you all for a week or so in order to make a journey to an Eastern land. Indeed, when you read these words I shall already be gone, and you can, in the words of the poet, think of me "far across the Eastern seas."

I have as a matter of fact been entrusted with an extremely delicate mission about which I hope, with the Editor's permission, to have something to say on my return. But I must desist, for even as I write, the car is waiting to take me to Croydon.

"Banzai!" as they say in Salford.

SIMPLE TONE CONTROLLED 12-watt AMPLIFIER

A Reader's Design for an A.C. Operated Equipment

THE amplifier briefly described in this note having proved most successful for public-address use and for providing dance music, a few details might prove of interest to readers of *The Wireless World* who have a number of components available that could be used or modified for the purpose.

With the help of *The Wireless World* "Radio Data Charts" several additional

themselves these charts are a most valuable asset.

The unit embodies two amplifying stages; in the first an MS/Pen.A valve is employed, and this is coupled by a parallel-fed transformer to two PP5/400 valves working in push-pull. By employing separate filament windings for each output valve, and carefully adjusting the grid-bias resistances, a perfect balance is

WHEN it is required to provide music for dance halls and clubs, an A.C. amplifier such as that described by a reader in these notes will be found very satisfactory. The push-pull output stage with provision for careful balancing should ensure high quality of reproduction.

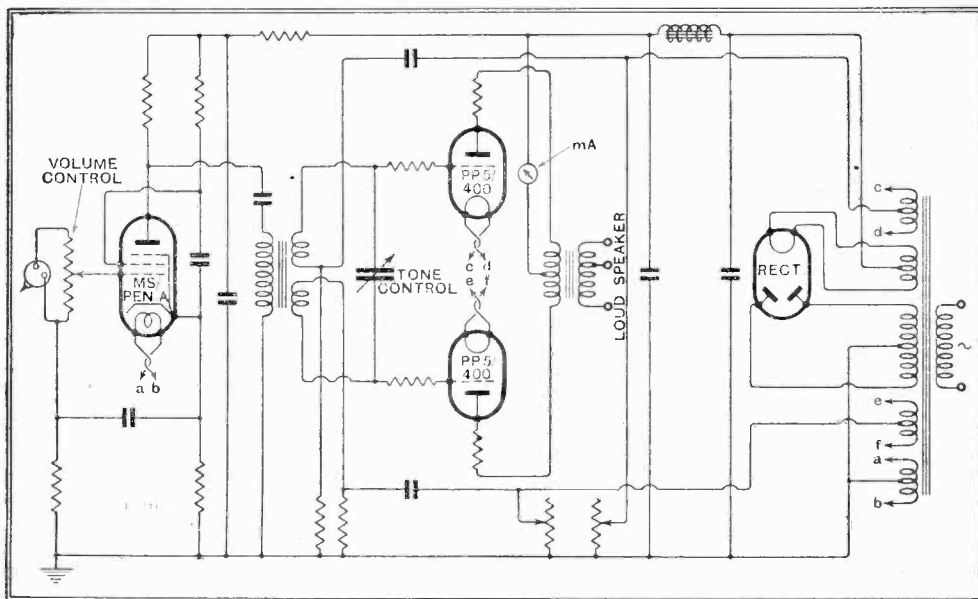

Circuit diagram of the tone-controlled amplifier.

filament windings were added to a mains transformer which on test were found to give the correct voltages. For experimenters who take an interest in working out problems of this nature for

achieved, so that the maximum efficiency is derived from this stage.

The rising characteristic of the H.F. pentode used in conjunction with the tone control—which takes the form of a variable condenser connected across the secondary of the intervalve transformer—is very helpful when matching the output to various acoustic surroundings and for correcting gramophone recordings.

The components are mounted on a channel-section aluminium chassis with some of the smaller parts and the whole of the wiring carried underneath.

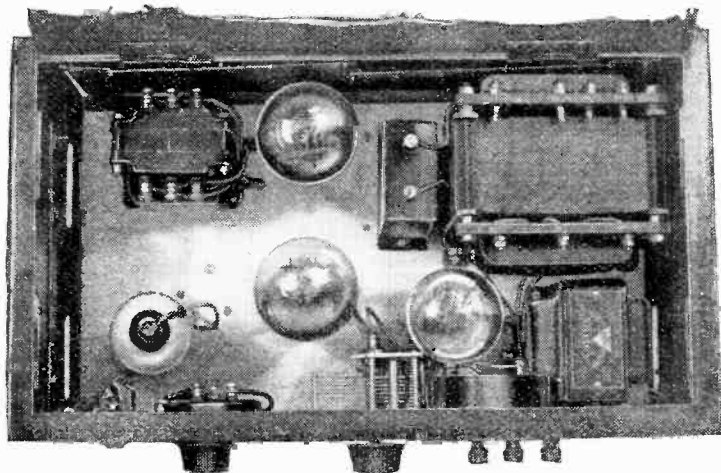

Plan view of the amplifier with lid removed.

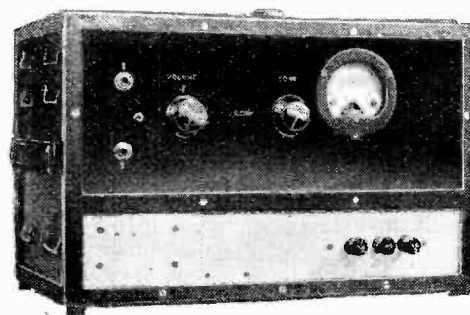

Showing the panel with the various controls, including an adjustment for tone.

Since the valves dissipate a considerable amount of heat, a well-ventilated light steel case, having a hinged lid, was constructed to house the amplifier.

An amplifier of this type is capable of giving high-quality reproduction at great volume, and can be especially recommended for public-address work and the like. The output stage delivers between ten and twelve watts of undistorted power, which, when fed to a good moving-coil loud speaker, provides ample volume to fill a large dance hall accommodating between three and four hundred people.

CLUB NEWS

Loud Speaker Thrills

THE famous steam-pipe speaker manufactured for 6s. 6d. by a member of the Croydon Radio Society distinguished itself at the last meeting when, in competition with several of the latest makes, it proclaimed its supremacy in overall response, despite a slight resonance at 2,500 cycles. The evening had been devoted to comparative tests of fourteen loud speakers, all reproducing the same cinema organ record. A celebrated dual loud speaker all but secured first place, but it failed through being rather weak on top notes.

Hon. Secretary: Mr. E. L. Cumbers, 14, Campden Road, South Croydon.

Varnishing Laminations

READERS of *The Wireless World* are invited to the next meeting of the Institute of the Plastics Industry, on Monday, February 13th, at the Windsor Castle Hotel, Victoria, London, S.W., at which Dr. E. G. Haefely will read a paper on "Varnishes and Laminated Materials."

Hon. Secretary (London and District Section): Mr. J. Taylor, 6, Barn Way, Barn Hill, Wembley, Middlesex.

Tone Control

DR. HUGHES, of the Multitone Electric Company, gave a lantern lecture on the Multitone System of Tone Control at a recent meeting of the Southall Radio Society. The lecturer compared different methods of sound reproduction and showed how defects could be obviated by the Multitone transformer, designed to abolish to a great extent audio frequency attenuation.

Hon. Secretary: Mr. H. Rayner, 11, North Road, Southall.

The Superhet in the Factory

HOW a Murphy Superheterodyne A.8 receiver is tested piece by piece in the factory was entertainingly described in a lantern lecture by Mr. P. K. Turner at a recent meeting of the Catford and District Radio and Television Society. A practical demonstration of the instrument revealed impressive quality and selectivity.

Hon. Secretary: Mr. H. W. Floyd, 38, Como Road, Forest Hill, London, S.E.23.

More About The QUIESCENT PUSH-PULL TWO

Further Notes on Operation Review of Components Submitted for Test

By W. I. G. PAGE, B.Sc.

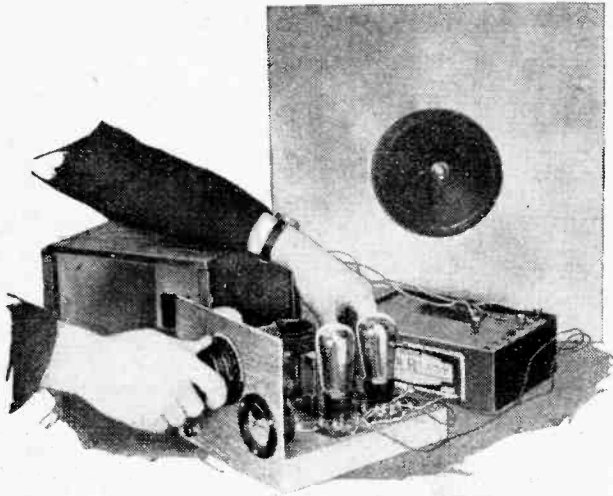

SINCE the first constructional receiver¹ embodying quiescent push-pull was described in this journal, a large number of intervalve and loud speaker transformers with characteristics suitable for this type of amplification have made their appearance on the market. From the wide variety of components available it is possible to make a choice to suit any Q.P.P. amplifier design with the knowledge that compromise can be avoided and that the circuit requirements will be fulfilled.

There are, for instance, a number of input transformers of different primary inductance and having ratios varying between 7 and 10 to 1, with the result that it is possible to apply the correct load to the detector valve in use and to ensure that the step-up ratio in the intervalve coupling is sufficient on full modulation to load two output valves in Q.P.P. Considerable attention has been given to the difficult task of matching the speaker to the Q.P.P. system, and manufacturers' efforts have now been well rewarded. The constructor will find on the market a series of output transformers with which it is possible to obtain powerful signals of good quality² from almost any loud speaker with a speech coil impedance varying between the wide limits of 2 and 2,000 ohms.

Matching the Pentodes

Experiments with the Quiescent Push-Pull Two reveal that whereas the permanent-magnet moving-coil loud speaker is undoubtedly the best reproducer for Q.P.P. circuits, really very pleasing results can be obtained with moving-iron instruments, *provided that an output transformer of correct ratio be chosen.* A special intervalve transformer embodying a continuously variable tone control is being manufactured, and will be found of great assistance in correcting the attenuation of high notes caused by side-band cutting which occurs in the less ambitious type of set when reaction is

¹ See *The Wireless World*, January 20th, 1933.

pressed to the limit. Furthermore, it is generally found that at high volume levels speech is made much more natural if the tone is raised above that which is found the most pleasing with music.

Some twenty components and accessories for the Quiescent Push-Pull Two have been sent in for review, but before describing their performance a few further hints on the initial adjustments of the receiver may not be out of place, especially as the process of matching the Pen. 220A valves was dismissed rather briefly in the original article.

First of all it should be made clear that the anode currents of the two pentodes must be matched by adjusting their individual auxiliary grid voltages, using the $1\frac{1}{2}$ -volt tappings provided in the special Q.P.P. high-tension battery, care being taken to switch off the set while making alterations. The common anode lead is taken to the maximum H.T. voltage tapping on the battery ($130\frac{1}{2}$ volts) and is left there permanently. Of the $16\frac{1}{2}$ volts of the bias battery only 14 to 15 volts are required, and as a potentiometer control is provided, voltmeter readings of the actual bias applied are liable to be misleading. It is therefore

random in the $1\frac{1}{2}$ -volt tappings near the maximum positive end of the battery, remove one pentode from its valve holder and take a reading on the milliammeter of the anode current of the remaining pentode. By adjusting the appropriate auxiliary grid tapping (the coloured leads in the multiple cable facilitate the tracing of wires) and by a very slight movement of the bias potentiometer, the correct current of 2 mA. can be made to flow.

Next replace the idle pentode in its holder and remove the brother valve, again changing the auxiliary grid voltage tapping until about 2 mA. flows, but this time the bias control must not be touched. As a final check the meter should show 4 mA. for the total quiescent anode current of the output stage.

The constant resistance shunted across the bias battery causes it to discharge at such a rate that the voltage drops in sympathy with the H.T. battery. It would be advisable after a month or six weeks to check the matching of the valves and to see that the total anode current is $3\frac{1}{2}$ to 4 mA. Although the meter must be short-circuited to prevent distortion while the set is working, it will be found to be of considerable value as an indicator of resonance when a note of constant modulation such as a tuning note

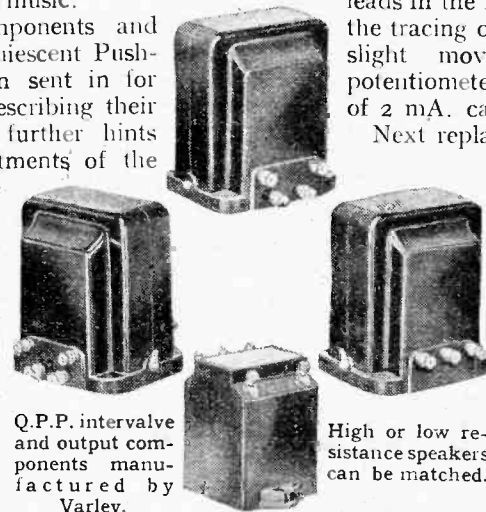

High or low resistance speakers can be matched.

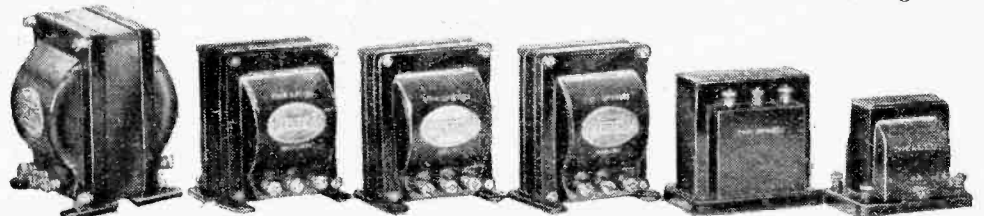

The Ferranti series of transformers, five of which have been specially designed for quiescent push-pull. The ratio of the output components ranges from 1.7 to 100 to 1.

necessary to judge the correct position of the slider by rotating its controlling knob to the extreme anti-clockwise position and then turning it back again about an eighth of its total travel—or about five minutes if the arrow on the knob is regarded as the minute hand of a clock.

Having set the potentiometer and inserted the auxiliary grid wander plugs at

from a local transmitter is being sent out.

At about thirty miles from Brookmans Park the tuning note can be made to increase the standing current from 4 to 9 mA. before oscillation occurs. Those living nearer to this transmitter could probably obtain an increase up to 12 mA.

Of special interest to the constructor are the Q.P.P. components introduced by

More About the Quiescent Push-Pull Two—

R.I., Ltd. This firm has been investigating the merits of this latest development in battery-economy circuits for some months, and the intervalve transformer designated the "Q" type, selling at 16s. 6d., including royalty, was found to load the output stage adequately. The ratio is 1 to 8, and, although a nickel-iron alloy is used for the core, up to 3 mA. may be passed through the

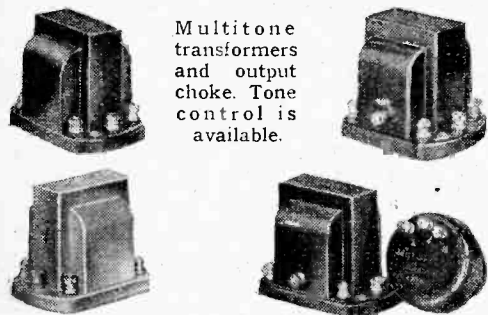

Multitone transformers and output choke. Tone control is available.

primary. The inductance of the latter is 30 henrys with no D.C. and 16 henrys with 2 mA. The output choke of this series provides four ratios, namely: 1 to 1, 1.4 to 1, 2 to 1, and 2.8 to 1, and enables almost any high-impedance speaker to be matched correctly. Each half-primary inductance is 70 henrys. This component is styled DY35, and sells at 12s. 6d.

Q.P.P. Chokes

The Varley range of Q.P.P. components include one input transformer and three output "Transchokes," the latter providing every conceivable ratio for matching both high- and low-resistance loud speakers. On test the intervalve transformer gave an extremely good account of itself, and the high ratio of 9 to 1 ensures that the output stage just runs into grid current when the detector is giving its maximum output. This was easily proved by interposing a microammeter in the common grid circuit. The primary inductance is 27 henrys with 2 mA. D.C. passing. The transformer is called the D.P.36, and sells at 17s. 6d., including royalty.

Of the output devices marketed by this firm mention should be made of the D.P.37 Transchoke, giving ratios of 3 to 1 and 42 to 1—the former for high-resistance speakers (or low-resistance speakers with built-in transformer) and the latter for the low-resistance type in which the speech-coil impedance is 10 ohms. The inductance of each half-primary is 13 henrys when D.C. peak currents of 26 mA. are passing. The price, including royalty, is 18s. 6d. Other Transchokes provide ratios of 3 to 1, 50 to 1, and 75 to 1.

There are a number of Multitone transformers for Q.P.P. available, and one of which is particularly interesting is styled PUCO 1/8, selling at 17s. 6d. By means of a special potentiometer connected across the centre tappings a continuously variable tone control can be obtained, which is a valuable asset, for instance, with gramophone reproduction, where

needle scratch and excess of "Top" can be successfully reduced. There are many other uses for this control, and it was found that when the transformer was used in the Quiescent Push-Pull Two reaction could be pressed considerably farther than hitherto, as the attenuation of high notes due to sideband cutting could be compensated. The primary inductance is 30 henrys with 2 mA. D.C. passing. Other transformers in this range are the PU 1/8, selling at 15s., and a high-quality transformer styled D4, with a ratio of 1 to 9 with the remarkably high inductance of 40 henrys with 2 mA. D.C. The price is 17s. 6d. The "Puchoke" output-matching device provides ratios of 3 to 1, 1.5 to 1, and 1 to 1, and is intended for high-resistance speakers or for use in conjunction with speakers having a transformer already built in. Tested with a Blue Spot 66K high-resistance unit (moving iron), using the intermediate ratio, the output level was high and the quality of reproduction quite satisfactory.

Ferranti have just entered the market with a range of five Q.P.P. transformers, of which illustrations appear herewith. Unfortunately, they arrived just before going to press and there has not been sufficient time for a complete test, but from the enviable reputation gained by this firm for the designing of push-pull transformers it can safely be assumed that the performance will be entirely satisfactory. Model AF11C is an intervalve transformer with a ratio of 1 to 10, and an inductance of 50/27 henrys when the primary current is 0 to 10 mA. The price is 34s., including royalty. There is an inexpensive input transformer known as the AF12C, with a ratio of 1 to 9, selling at 15s. In the output transformers type O.P.M.13C is interesting, as ratios of 1.7, 2.7, and 4.5 to 1 are available, making the component suitable for use with high-resistance speakers or with the low-resistance type having a built-in transformer. The price is 26s. 6d., including royalty. Another type—O.P.M.11C—in this range caters for low-resistance speakers, and provides ratios of 35, 56, and 100 to 1.

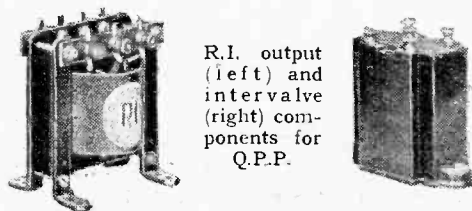

R.I. output (left) and intervalve (right) components for Q.P.P.

Four permanent-magnet moving-coil loud speakers with special Q.P.P. transformers built-in have been received for review. In each example the speaker-transformer combination has been designed to impose a load of about 18,000 ohms at approximately 256 cycles. In the case of the B.T.H. R.K. Minor speaker the transformer has a very liberal core, ensuring high efficiency. The volume was rather greater than with any other speaker tested, and the tone was distinctly pleasing. Slight predominance of upper frequencies existed, but this was at once

rectified by increasing the value of the condenser in the compensator circuit across the transformer primary. It is called the Q.P.P., and the price is 57s. 6d.

New Speakers

The Amplion speaker in this range (type Q.P.P.) gave an entirely satisfactory performance and was especially pleasing with music, the bass notes being well reproduced. The pentode compensator circuit with the original values unchanged should be used in this case. The price of the speaker is 39s. 6d. A Rola speaker, type "Q," selling at 52s., is available. On test the response was found to be substantially uniform over the

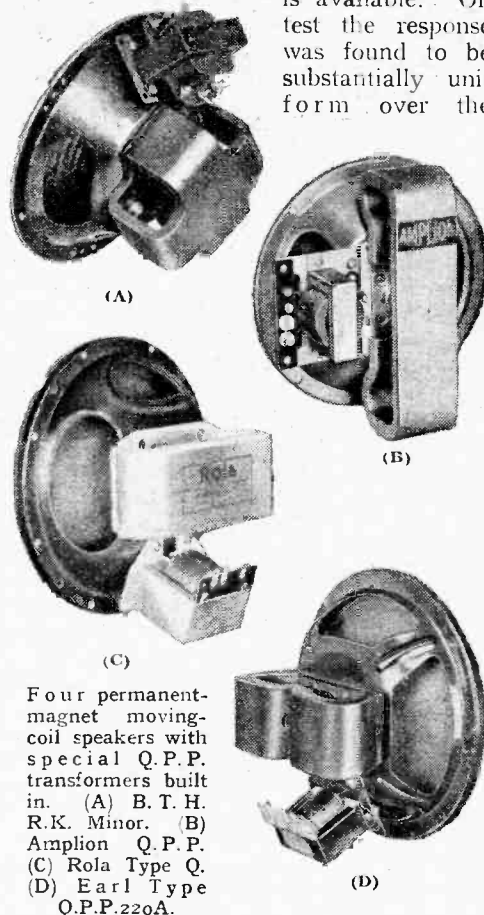

Four permanent-magnet moving-coil speakers with special Q.P.P. transformers built in. (A) B. T. H. R.K. Minor. (B) Amplion Q.P.P. (C) Rola Type Q. (D) Earl Type Q.P.P.220A.

musical range, and the standard compensator was used.

Electriclocks and Radio, Ltd., are marketing the "Earl" Q.P.P.220A speaker embodying a transformer with nickel-alloy core. The reproduction is brilliant, and speech is exceptionally natural, but with musical items it was found that the value of the capacity in the compensator circuit should be increased from 0.005 mfd. to 0.01 mfd. At 35s. this speaker represents good value for money. A new Q.P.P. high-tension battery—the Ever Ready Type W.1198—has just made its appearance, and is tapped at the appropriate 1½-volt intervals. The price is 12s. 6d.

It is interesting to note that this specialised type of push-pull output is finding its way into commercial receivers, and among the pioneers who have adopted this design may be mentioned the Consolidated Radio Co., Ltd.

It is hoped to deal shortly with the advantages of triodes in Q.P.P.

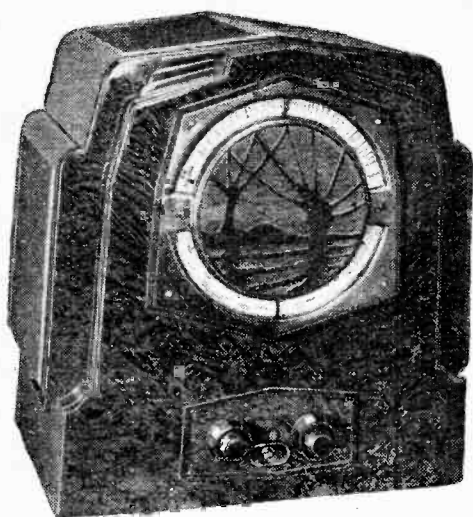

EKCO SH25

SUPERHETERODYNE

A Self-contained Station-calibrated A.C. Receiver

THE popularity of the superheterodyne has now established itself as firmly in the small, self-contained receiver as in the more ambitious instrument of the radio-gramophone class. In spite of its apparent complexity when compared with a straight receiver, it is actually easier to build a superheterodyne of good performance than a straight set within the confined space of the usual cabinet, for it is far less prone to instability, and it does not suffer in the same way by having its components placed in close juxtaposition. Thus, while the performance obtainable from this type of set is particularly pleasing to the user, the latitude which is permissible in the layout commends it to the designer, so that it is small wonder that the straight set now appears to be slowly dying.

Five valves are employed in the Ekco superheterodyne, and it may be said at once that a very satisfying performance has been obtained. The quality of reproduction is definitely good, and the high notes are very well reproduced. The bass is present, but appears at a somewhat lower level, owing to the small baffle area provided by the containing cabinet. It is good to see a design, however, in which the temptation to include a false bass by speaker and cabinet resonance has been resisted, and the net result is very pleasing quality with no trace of boominess.

Background Noise Absent

The selectivity is well up to the standard of the average small superheterodyne, and stations up to about 18 kc. from the local can be received without interference. Since stations closer to the local than this are always apt to be spoilt by sideband heterodyning, the selectivity may be said to be sufficient for most practical purposes.

The sensitivity, too, is entirely adequate, and, in fact, during the tests the volume control never had to be set to maximum for even the weakest signal. Background noise is low, and whistles—the chief defect of many superheterodynes—are almost entirely absent. The two usual points of second channel interference are found for the two locals, of course, but other whistles are very few in number indeed. The

volume control, in conjunction with the Local-Distance switch, offers a smooth, continuous, and distortionless variation of volume from maximum to silence on all stations, including the locals, and, in fact, the range of control is unusually wide.

Mechanically, the receiver is very well constructed indeed, and the steel chassis is exceptionally rigid, while the layout of components and the general design bear witness to considerable thought on the part of the designers. The cabinet is of bakelite, and the well-known Ekco tuning scale is fitted around the speaker fret. This, of course, takes the form of a circular strip on the outside of the speaker cone, over which a chain-driven pointer travels to indicate, by wavelength and by name, the station to which the set is tuned. The accuracy is reasonably good, and no difficulty was found in identifying stations by the dial reading, even although the pointer did not always happen to coincide exactly with its marking.

Electrically, the circuit is arranged as a variable- μ first detector, preceded by a two-stage inductively coupled band-pass filter for the pre-selector. Individually screened coils are not used in this filter, and the coupling is by mutual inductance, for the primary and secondary are actually wound end to end on the same former—a very simple and effective arrangement. A separate triode oscillator valve with a tuned anode circuit is used, and the coupling to the first detector is arranged by including the oscillator grid coil in its cathode circuit. The oscillator coils are completely screened, and, moreover, a screen is fitted to the oscillator valve itself.

A single variable- μ H.F. stage is used, and the two I.F. couplings are each of the band-pass type, there is thus a total of four tuned I.F. circuits, and it is these which provide chiefly the adjacent channel selectivity. Here, again, complete screening of the circuits is provided, both for the purpose of ensuring complete stability and of preventing the direct pick-up of morse working on the wavelength to which the

I.F. amplifier is tuned. Indeed, so important has this latter feature been deemed that a special tuned rejector circuit has been included in the aerial circuit to prevent such signals from forcing an entry by this path.

The second detector is another triode acting on the power grid principle, and it is resistance-transformer coupled to the

pentode output valve, which in turn feeds the moving-coil loud speaker in the usual way through a transformer. The speaker field is energised from the mains equipment, where it also serves as a smoothing choke. The speaker field alone, however, is not relied upon for smoothing, and an additional choke is included, together with large-capacity electrolytic con-

densers, and the net result is an exceptionally low level of hum in the output. A metal rectifier is used to provide the H.T. supply.

Sockets are fitted to the rear of the chassis for the connection of an additional external loud speaker and also for a gramophone pick-up, while a plug permits a mains aerial to be employed. There are two main controls on the front of the cabinet—the tuning control and the volume control—and these are provided with large-diameter knobs. Concentric with these knobs are two smaller controls, one operating the Local-Distance switch, and the other the combined wavechange and radio-gramophone switch. The mains on-off switch is fitted to the rear right-hand side of the chassis and is readily accessible. There is in addition a tone control switch, which connects a filter circuit to the second detector valve and permits the higher musical frequencies to be severely attenuated when heterodyne whistles and atmospherics render such a course advisable.

The appearance of the receiver, with its moulded bakelite cabinet and its unobtrusive tuning scale, is particularly pleasing, and is calculated to satisfy the tastes of the majority as is also the oxydised metal speaker grille.

FEATURES

General.—Five-valve A.C. superheterodyne with built-in moving-coil loud speaker. Special station indicating and wavelength calibrated tuning scale. Provision for the use of an external speaker and for the connection of a gramophone pick-up. A mains aerial is provided.

Circuit.—Variable- μ first detector and I.F. stages, with a separate triode oscillator and a triode second detector; pentode output. The pre-selector is coupled by mutual inductance, and a special rejector is included to prevent I.F. interference.

Controls.—(1) Tuning control. (2) Volume control. (3) Local-distance switch. (4) Combined wavechange and radio-gramophone switch. (5) Tone control switch. (6) Mains on-off switch.

Price.—21 guineas.

Makers.—E. K. Cole, Ltd., Ekco Works, Southend-on-Sea.

Modern Superheterodyne Practice

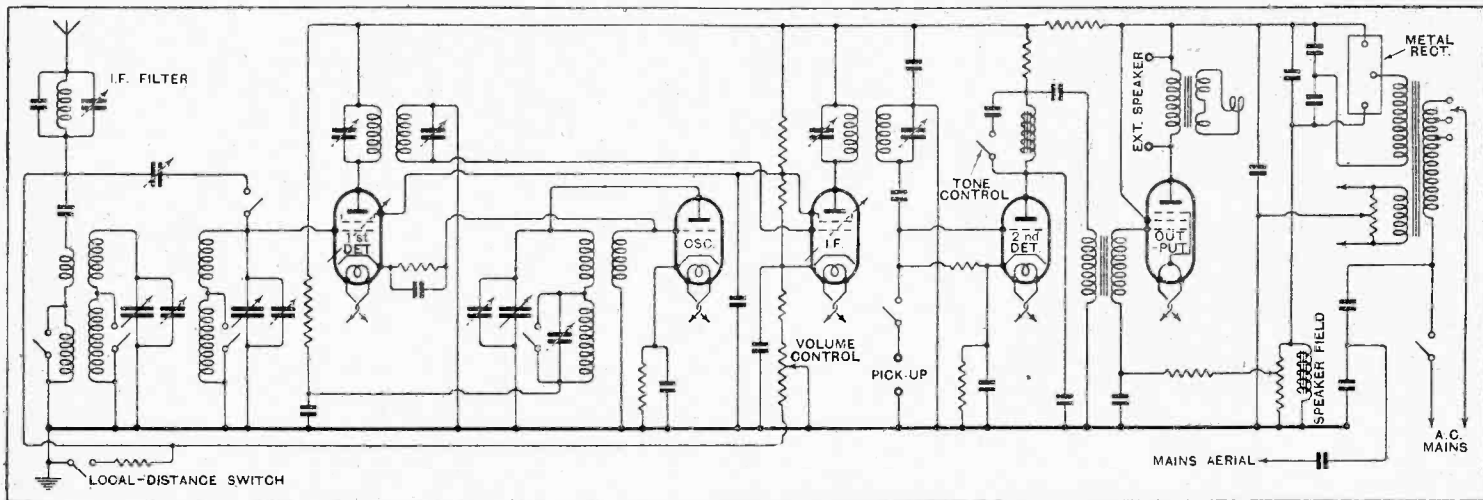

Complete circuit diagram. Points of interest are a variable-mu first detector, a rejector to prevent I.F. interference, and a two-valve frequency changer.

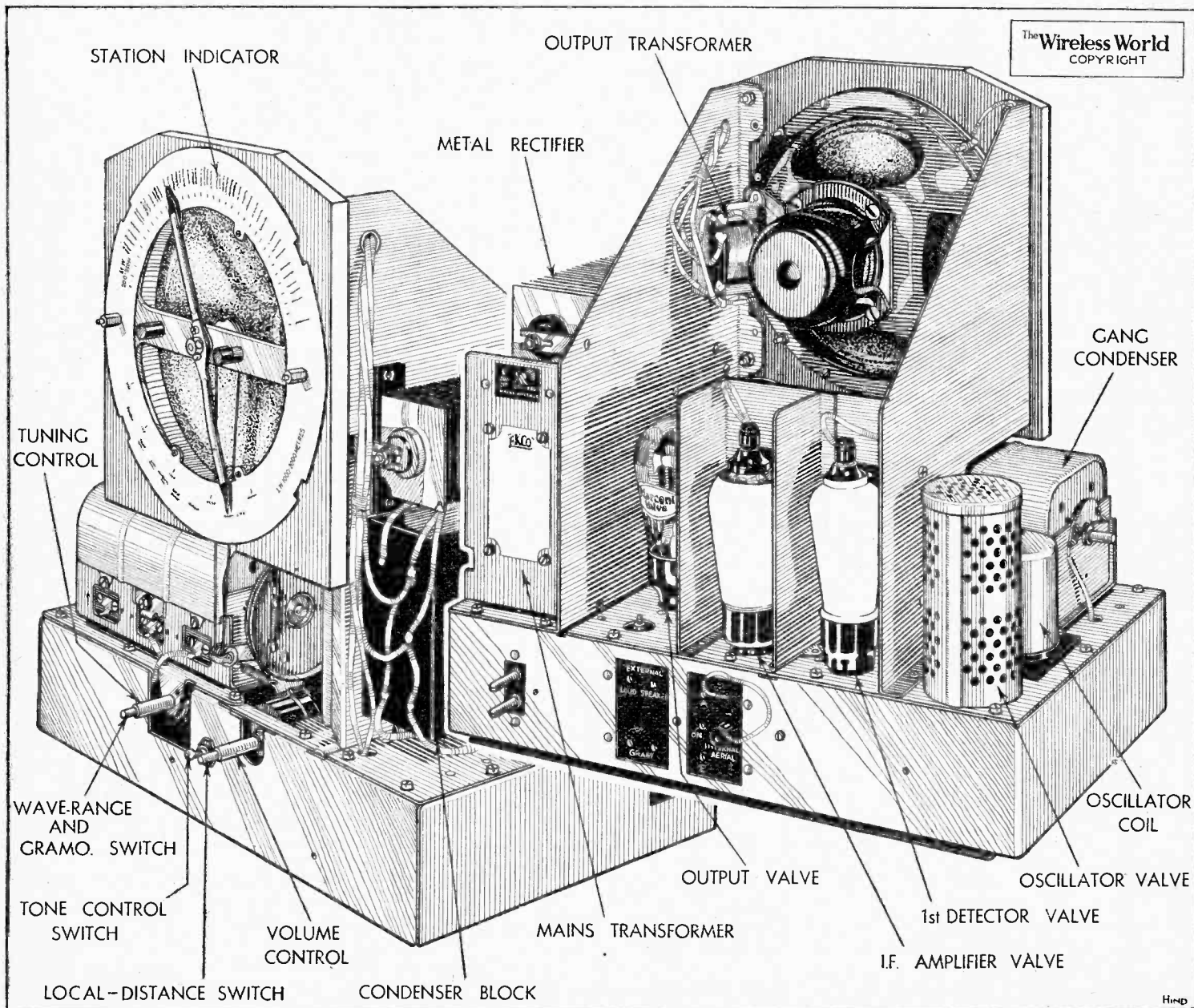

Two views of the chassis, which is of robust all-metal construction.

Practical HINTS AND TIPS

AIDS TO BETTER RECEPTION

IT is not usually recommended that variable condensers should be dismantled or in any way tampered with; this is distinctly a specialist's job, and many of us who rather fancy our skill in making critical adjustments to wireless apparatus have come badly to grief when attempting this sort of work.

Kill or Cure

If one is unfortunate enough to have an out-of-date ganged condenser with inaccurately matched sections the most certain and obvious cure is to replace it by a modern component,

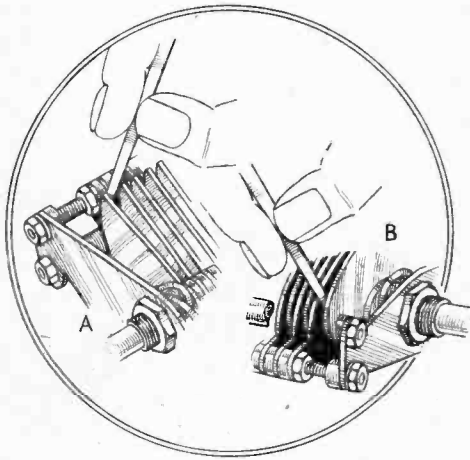

Fig. 1.—Correcting errors of alignment in ganged condensers by displacing the end vanes.

of which all the sections can be depended upon to have the same capacity at corresponding angular settings of the rotors. But, before scrapping a fairly expensive piece of apparatus there is a natural temptation to try to improve matters; there is no harm in making the attempt if it is realised that it will very possibly fail, and so, after all, a new condenser will be required. A set with a tuning system that is badly out of alignment is always a source of dissatisfaction to its owner.

This note relates to condensers with solid plates, and not to the more modern type with segmented end vanes, which are accurately matched at various angular settings by the makers. For example, it may be found that one of a series of cascade ganged circuits runs out of tune with the others as wavelength is progressively increased, and requires less trimming capacity at the higher wavelengths to maintain resonance. In these circumstances it is by no means impossible to effect a great improvement by reducing the rate of capacity increase of the condenser section which controls that particular circuit. If one of the rotor end vanes overhangs the stator bank this vane may be bent outwards, as shown in

Fig. 1A, so that, instead of being parallel with the rest of the vanes, it makes a more or less acute angle with them. To arrange matters so that the rate of capacity increase be reduced, a little thought will show that it is the "tail end" of the rotor plate which must be bent outwards.

It is equally possible that the defect in ganging may manifest itself in a different way, more trimming capacity being required for the mis-aligned circuit as wavelength is increased. If so, the tail end of the rotor plate may be bent inwards as far as is consistent with the avoidance of a short-circuit, and at the same time the tip or entering edge is bent outwards, as shown in sketch B.

When neither of the rotor end vanes overhang the stator it is just possible to make a similar adjustment by bending one of the stator vanes. To do this the vane to be adjusted must be cut through with a small saw or file at one of its points of attachment.

With a little skill and patience—and perhaps, one should add, with a little luck as well—it is possible to make a remarkable improvement in matching.

IT has lately been found that the type of filter circuit shown in Fig. 2 (a) is especially likely to aggravate the effects of induced electrical interference in the aerial-earth circuit. Careful consideration will show that the decoupling resistance R is effectively in series with this circuit, and that any voltage built up across the resistance will be transferred to the grid of the first valve. The coupling condenser C, though in parallel with the resistance, will usually have such a low capacity that it will not act as an effective by-pass to impulses of low frequency.

In one case, where electrical interference was particularly annoying, it was found that matters could be greatly improved by isolating the aerial circuit by providing a separate winding, as in Fig. 2 (b). The use of a separate aerial winding is also to be advocated from other points of view, and for the particular trouble under consideration affords the most effective cure. But, as an alternative, the expedient of reducing the

value of the resistance R may be tried; a resistance of a few hundred ohms, or even 1,000 ohms, in place of the higher value usually specified, may be quite effective, and is certain to reduce interference brought about by induction.

IN many devices for tone correction and the suppression of heterodyne interference air-cored inductances of half a henry or so are often required. The constructional details of these components have from time to time been described; in order that the finished choke may be of reasonable size it is usual to specify enamelled wire.

Winding Air-cored Chokes

It is worth while to point out that the effect of even two or three short-circuited turns will be serious, and so the greatest care should be taken to avoid damage to the covering of the wire. If a joint is necessary it should be carefully soldered, and then the exposed metal should be covered with Empire cloth or some other suitable form of insulation.

IT has been found that almost any modern three-electrode valve works well as a diode detector, and that there is surprisingly little difference in the performance of the various types. For a given load (or coupling resistance), however, low-impedance valves are rather more efficient, but the difference is seldom enough to be audible.

Valves for Diode Detection

Certain valves of very low impedance have an exceptionally high inter-electrode capacity, and so may appear to be more effective diode detectors, because, in effect, the capacity of the valve is additive to that of the by-pass condenser

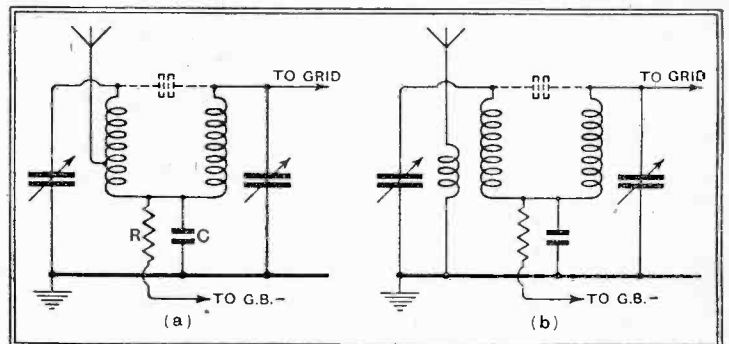

Fig. 2.—A separate aerial winding (diagram (b)) is generally preferable to a tapped connection. The arrangement shown in diagram (a) is likely to intensify certain forms of electrical interference.

already provided. There is a risk that any gain in sensitivity obtained by using one of these valves will be off-set by a slight loss of high notes.

Practical Hints and Tips—

DURING the last two or three years so-called thimble connectors have been widely used in electrical wiring. These devices, which are shown at approximately their full size in an accompanying sketch, are made of porcelain; the internal taper of the cone is threaded, the edges of the threads being sufficiently hard and sharp to cut into any soft metal like copper.

Thimble Connectors

At first sight these devices would not appear to have any application to the construction of wireless sets, but a trial shows that they are surprisingly useful and effective for making alterations to internal wiring. Two or more wires to be joined together are merely inserted in

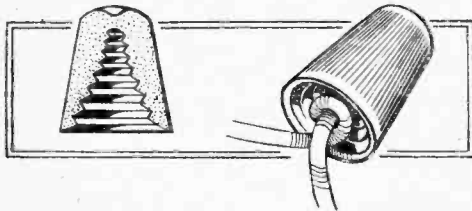

Porcelain thimble connectors, though primarily intended for ordinary electrical wiring, are particularly useful for making semi-permanent alterations to the internal connections of a receiver.

the cone, which is then given a few turns in a clockwise direction; by this action the wires are twisted closely together.

In addition to providing a good electrical connection, the porcelain cone also acts as an insulator, provided that the bared ends of the wires to be joined together do not protrude beyond the base.

This method of connection probably shows to best advantage when space is limited; any of the classes of wire customarily used for internal connections can be joined together, and, for example, it is possible to connect flexible stranded leads to each other or to solid wires. Even when soldered connections can be made, the addition of a thimble provides at least as good insulation as a wrapping of insulating tape, and is easier to put on.

WHEN the subject of Q.P.P. amplification with output pentodes has been discussed in the pages of this journal it has been emphasised that the primary of the L.F. coupling transformer should be shunted with a resistance of about

Quiescent Push-pull

75,000 ohms in order to avoid risk of damage due to voltage surges. Those who intend to use this

system, but propose to employ a resistance-fed intervalve transformer, will be interested to know that with this system the shunt resistance will no longer be necessary. The presence of the normal anode-coupling resistance, which is effectively in parallel with the transformer primary, will prevent the development of unduly high voltages, even though the circuit be interrupted by withdrawing the detector valve from its holder while the set is in operation.

IT will sometimes be found that more clearly defined absorption (or reduction of the strength of incoming signals) is obtainable when the aerial connections to *The Wireless World* Station Finder (January 13th) are reversed. This reversal is effected by joining the aerial lead-in to socket R, and the receiver aerial terminal to socket A1 or A2, depending on coupling requirements.

A Station Finder Hint

It has also been observed that the calibration of this device may tend to alter slightly after the first two or three days'

use. The variation will usually not be serious enough to cause ambiguity between stations, and is probably due to "bedding-down" of the condenser bearings, and to the fact that the sweep of the moving vanes is slightly increased in use. If this effect is noticed it is as well to re-set the zero adjustment in the manner described in the original article; this will only take a few minutes. At the same time, the condenser dial should be re-set if necessary, so that the zero mark on the dial corresponds accurately with the datum line when the moving vanes are completely disengaged from the stator.

NEW USE FOR PHOTOCELL

Averting Damage to Printing Machinery

ONCE more the photo-electric cell has been called upon to replace the fickle "human element"—this time in the service of printing. In co-operation with the General Electric Co., the Cornwall Press Limited, printers of *The Wireless World*, have now introduced the photo-electric cell as a "watcher" to prevent the damage so often caused to printing machines by paper breakage.

A photocell is utilised on each web and the main amplifier with its relay is fitted at a convenient point away from the machine.

In a recent demonstration given to show the effective action of the photo-electric control, the whole machine came to rest completely in about two seconds after the fracture of the paper.

Without any such device a breakage

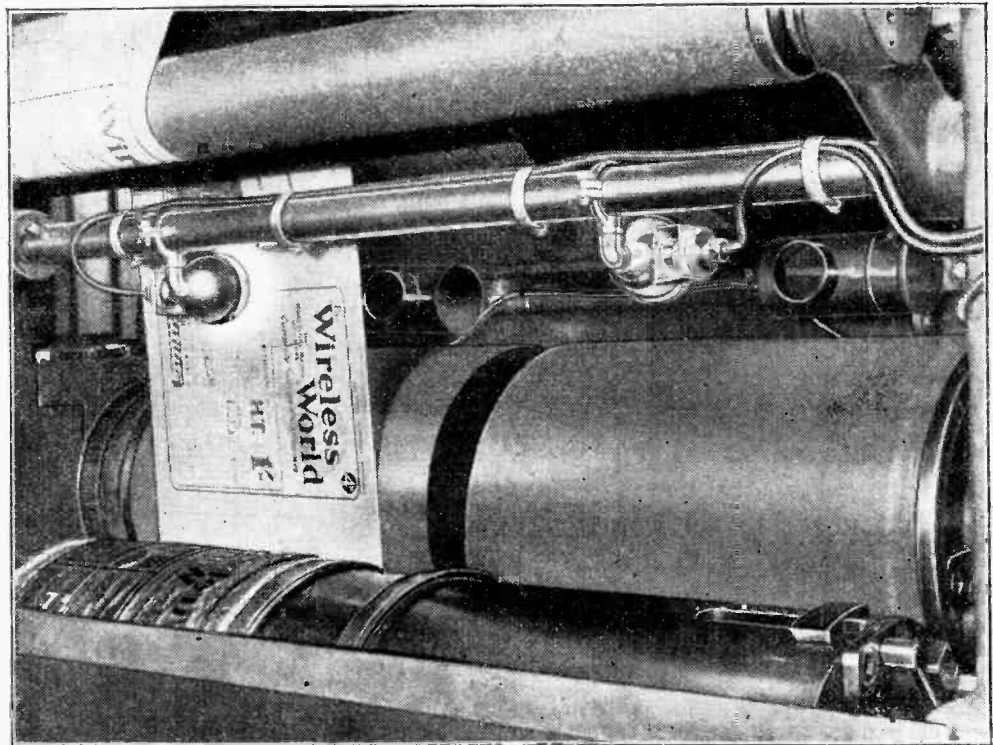

A picture demonstrating at a glance how the photo-electric control operates in a modern printing machine. So long as the paper intercepts the beam of light the machine continues to operate. If the paper breaks, the beam is thrown on the photocell, which actuates a valve relay and the machine is stopped.

In this particular installation a small lamp is fitted to illuminate one side of the sheet of paper as it passes through the machine; the photocell is in a specially designed housing on the opposite side of the sheet. Normally, the paper obstructs the passage of the light and the photocell is kept dark, but immediately a fracture occurs, light reaches the cell, the valve relay contacts close and bring into operation the mechanism which stops the machine.

will, if unobserved, often cause the loose web to wind itself round the cylinders so that the printing plates may become damaged, for, unfortunately, it is impossible to be certain that a breakage will be detected in time by the operators. In addition to the cost of the actual material damage the waste of time involved in removing and replacing any damaged parts is very expensive. The photocell averts the danger in the most practical and convincing manner possible.

BROADCAST BREVITIES

New Blood in Vaudeville

MR. LANCE SIEVEKING, who last September took over the direction of broadcast vaudeville in order to devise new ways of putting us in a good humour, will relinquish the task next month. Everyone at Broadcasting House is asking who will succeed him.

Advice on Variety

At first it was believed that Eric Maschwitz would desert his editorial chair and take full command of vaudeville, but I understand that a compromise is likely to be effected, with Maschwitz as vaudeville consultant, adviser, or what you will, and that trusty servant of the public, John Sharman, in actual charge.

John Sharman

Sharman's name is little known to the listening public, but the truth remains that he has been responsible for more successful vaudeville and variety shows in the last few months than anyone else. On several occasions the Governors themselves have registered satisfaction at a particular vaudeville show, and in each case it has subsequently been discovered that Sharman was the originator.

Vaudeville v. Opera

Broadcast vaudeville has certainly taken up the challenge recently thrown out by studio opera, with which Gordon McConnell is hoping to make Britain "opera-conscious," at the expense (one supposes) of vaudeville.

I understand that within the next few weeks vaudeville devotees may be entertained by a famous Irish tenor whose name is a household word all over Europe and America.

A Dismal Audition

A friend of mine gave moral support the other day to an unfortunate member of the B.B.C. staff whose job it is to hold preliminary auditions of candidates for the vaudeville microphone. There is a wealth of tragedy in that word "preliminary," for auditions such as these are intended to meet the first onslaught of aspirants and decimate their ranks, leaving a few lucky ones to meet the gods on Olympus.

During the audition in question all thirteen "turns" were turned down. This sort of thing goes on from day to day.

Dr. Boult to Conduct Vienna Broadcast

A SYMPHONY Concert will be relayed to London Regional listeners on March 2nd, from Vienna, in co-operation with the Austrian Broadcasting Company. Dr. Adrian Boult, Music Director of the B.B.C., will conduct the Vienna Philharmonic Orchestra, the programme consisting of works by Mozart and Brahms, as well as some English works, the composers represented being Elgar and Holst. Dr. Boult was invited to direct this concert as guest conductor in the Viennese Orchestra's big winter series.

By Our Special Correspondent

A Harry Tate Station

DAVENTRY 5XX is the old crock among European broadcasting transmitters, and breakdowns are now so frequent that the station has quite a Harry Tate atmosphere.

Naturally, the B.B.C. is unwilling to purchase new components for a station whose days are numbered, so I am afraid that 5XX listeners will have to possess themselves in patience until Droitwich relieves the strain.

Not What it Seemed

A photograph reached me last week showing what appeared at first glance to be an early Victorian broadcasting station with a heavy timber lattice mast and a hutlike transmitting room at the base. Closer inspection revealed that the contraption was a primitive boring machine which is tapping the ground below the Droitwich site to discover whether mineral salt deposits are likely to interfere with the construction of the new B.B.C. station.

The station, by the way, is not expected to start transmission before the autumn of next year.

Empire Broadcasting: The Programmes

IT is to be hoped that the programme side of Empire broadcasting will justify the technical success of the venture. Judging from the comments of a New Zealand correspondent, I imagine that people in the Antipodes are by no means satisfied with what has already been issued to them.

"Too many 'talks and gramophone records are not wanted," writes the New Zealander. "Our stations have as good a selection of gramophone records as the B.B.C. Relays of special events will be welcome, and we should like to listen to speakers of distinction who otherwise could not be heard out here."

Royal Interest

This last wish should have been amply realised yesterday (Thursday) for the Prince of Wales (according to my information at the time of writing) arranged to go to Broadcasting House specially to broadcast to the Australian Zone the speech which His Royal Highness had made the evening before at the New Zealand Day Dinner at the Savoy Hotel.

Unfortunately for Australia and New Zealand, broadcasts of such importance as this will be rare.

No More Mike Tests?

AFTER many experiments with condenser and other microphones, the B.B.C. engineers seem to have gone back to their early love, the Marconi-Reisz. Whereas two or three months ago the visitor to Broadcasting House never knew what sort of mike he would find in any particular studio, in the majority of cases the Reisz has been reinstated.

In the Reign of George III.

AN unusually promising programme of the "réminiscences" type is to be heard by National listeners on February 18. Mr. Leslie Baily, the producer, will go back one hundred and fifty years and give listeners a concert at Vauxhall Gardens, "Rosina, or Love in a Cottage," as played at the New Theatre Royal, Covent Garden, in the reign

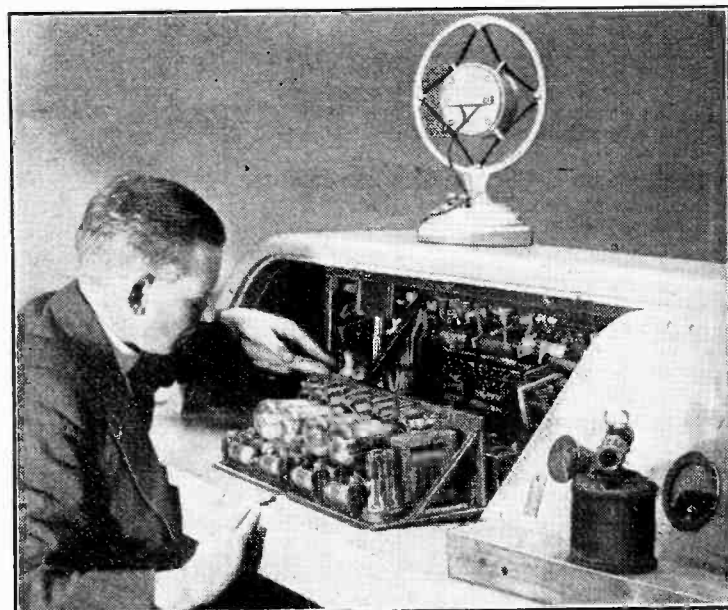

PREPARING FOR DRAMA. A B.B.C. engineer making adjustments at the rear of the Dramatic Control Panel at Broadcasting House. By the use of this panel a radio play producer can control the outputs of a dozen studios.

of George III, a discourse by Sir Horace Walpole from "To-night's Debate in the House," and a word from Dr. Samuel Johnson.

"Chu Chin Chow"

AN important dramatic broadcast is being arranged for April next. This will be "Chu Chin Chow," the wartime play which ran at His Majesty's Theatre, London, from 1916 right through to the end of the war.

"Chin"

Mention of "Chu Chin Chow" reminds me of a note received from a Japanese correspondent who tells me that a new censorship has been instituted because a well-known medical professor broadcasting from JOAK, Tokio, used the Japanese pronoun, "Chin," meaning "we," in an idiomatic form reserved exclusively for the Emperor.

The Chief of the Social Education Bureau happened to be listening.



Correspondence

The Editor does not hold himself responsible for the opinions of his correspondents
Correspondence should be addressed to the Editor, "The Wireless World," Dorset House, Tudor
Street, E.C.4, and must be accompanied by the writer's name and address

What Does the Public Want?

IT is a pleasure to read the letter from "Diagnostic," to read the comments of someone courageous enough to stand up to that bogey called Selectivity. And "bogey" is the only word for it. I have in mind a well-known receiver, for which the chief selling appeal is selectivity, which will receive anything between 20 and 30 stations under fair conditions, and yet in the London area cannot separate London National from London Regional!

Twelve months ago, one manufacturer was courageous enough to spend hard money in trying to establish whether selectivity was justified, and although in these columns I cannot deal with the means used to establish the point the evidence was such as to determine the manufacturer to drop a high power "selective" set he had in mind and concentrate on a cheaper model "for the locals." But I can say this, that the sum total of the investigation proved that about 95 per cent. of several hundred listeners quite obviously did not listen to foreign stations. By "listening" I mean receiving a foreign station for a total time of half an hour a week.

Your correspondent finishes his letter with the sentence, "... perplexities of technical design are as nothing compared with the perplexities of estimating what the public wants." That is perfectly true, but just as research will solve the problem of technical design so, too, will research solve the problem of determining what the public want. The average manufacturer's guide is purely and simply the fashion of the moment. Half a dozen instances in support of this at once leap to mind, but as each in turn would probably start a controversy of the same nature as the present one, it is perhaps better to leave them unsaid.

ADVERTISING AGENT.

Gordon Square, W.C.1.

I HAVE read with interest the letter by "Diagnostic" in your correspondence space on the relative advantages of home and foreign listening, and would like to make the following observations in reply.

"Diagnostic" states that in his own experience, he has yet to meet a listener who consistently relies on foreign broadcasts for real entertainment. Speaking for myself, I rarely listen to anything else.

I make no claims to obtaining satisfactory results for any length of time from stations broadcasting between 200 and 450 metres, but there are several stations radiating above 450 metres, which I find can be thoroughly relied upon, both for quality of reception and good entertainment value.

I refer in particular to Beromünster, Langenberg, Prague, Munich and Budapest. Naturally I do not receive these stations with the same degree of clarity and strength as that of the West Regional transmitter, twelve miles away, but they are all considerably superior to the Northern, Midland, and London Regionals, which offer poor reception in South Wales.

Additionally, if intelligent use is made of the foreign programme section of *The Wireless World* it is almost always possible to obtain a pleasing programme from one or the other of the above stations, at any time after dusk, a godsend when one is more or less tied to the National programme for home amusement.

My receiver is no better than the average, being an all-electric set incorporating two screen grid stages, but I still maintain that good entertainment can be had regularly from abroad on the wave lengths mentioned, and when I change my set, selectivity and ability to obtain a fair range of programmes, will be my first consideration.

"EUROPEAN LISTENER."

Newport, Mon.

IT would be interesting to listeners here in South-west Cornwall if your correspondent "Diagnostic" would inform us which station is our local.

All the Regionals fade too badly for us to hear a satisfactory programme.

Poor old 5XX does its best, but it is not uncommon, especially during autumn and spring, for it to fade and distort so badly that we cannot even hear the News Bulletin from beginning to end.

We have always been dependent on the Continental stations for our entertainment, but since the arrival of the new high-power stations, which fade very little, listening is much more of a pleasure than it was formerly, and I would add that your weekly programme, with its full list of items, is a great boon.

We want all the sensitivity and all the selectivity that can be put into our sets, and the supplying of these by the makers is in the right direction.

Your correspondent is welcome to his local set; it would be of no use here.

Cornwall. GEO. EUSTACE,

Eng.-Lt.-Commander, R.N.

(retired).

MAY I through the medium of *The Wireless World* have the pleasure of making the acquaintance of your correspondent "Diagnostic," so that he may at least come across one person who makes a practice of listening continuously to foreign programmes?

Of course, the word continuously may be construed in many ways. If he means it in its dictionary sense of "without interruption" I plead not guilty and withdraw, but if he means one who, dissatisfied with the everlasting organ recitals, dance music, same old orchestras on the same days of each week as the B.B.C. puts out, turns to something fresh, then I am one of the men he wishes to know of.

Retired from business, with gardening and wireless as my two prime interests, I turn each morning, afternoon and evening to the Continent, taking only the news and talks in which I may be interested from London, finding many Continental stations whose programmes can be received equally as well as those of the B.B.C.

If, in receiving a programme, fading or

morse sending intervenes, one can usually find a relay station free from interruption and so continue the listening.

So I say to the manufacturers, go ahead on the lines upon which you are working. Give us still better distant reception, for the number dissatisfied with the present programmes of the B.B.C. is growing every week. You are indeed catering for a real demand.

Middlesex.

Wm. H. R. BRUCE.

I READ with interest the letter from "Diagnostic" in Jan. 27th issue of *The Wireless World*, and think that he must indeed have "struck an exceptional patch of the genus listener" to arrive at the conclusions expressed therein.

Take my own case. My main interest lies in opera, and if I had to depend on the B.B.C. for operatic relays I should fare very badly indeed.

The occasional act from an opera relayed by the B.B.C. is no good to anyone. It has no value to those uninterested and is very unsatisfying to opera-lovers, and in this respect "the B.B.C. programmes are inferior to foreign ones."

It may surprise "Diagnostic" to learn that this past week I have heard five operas from abroad, including a performance of "La Gioconda" with Gigli and Formichi in the cast—names which I think prove the point doubted by him, "that the somewhat lower standard of reliability and quality of reproduction is far outweighed by the brilliance of the foreign programmes."

As a matter of fact the opera mentioned was relayed by Rome and the reception was of a very high standard, and during the four hours' relay fading did not occur once, which I think shows that (2) "foreign programmes can be heard satisfactorily."

I personally know many people who spend several hours every week listening to foreigners, and I am looking forward to the time when I possess a set such as the A.C. Menodial when I shall have even more stations at my service.

Canonbury, N.1.

J. C. SANSOM.

I THINK "Diagnostic" is about right. Manufacturers are continually worrying the public to buy something which the public does not want, but which the manufacturers think the public should have, and can be persuaded to buy. The more foreign stations held out as bait the more components does the listener require. Out-of-date sets must be scrapped and new ones bought to furnish the requisite selectivity.

Personally, I do not listen to foreigners, as I prefer quality to the nuisance of fading, atmospheric, and other interferences, and, anyhow, a record of "How Deep is the Ocean" is no better because it comes from abroad than it is when it comes from London—not so good, in fact.

When I visit my "foreign-listening" friends they usually run me round the foreigners, stopping about ten seconds at each one, to show what the set will do, but when they settle down to listen, I notice, it is the local station which is relied upon to provide the entertainment.

Correspondence—

Advertising will sell nearly anything, and if the manufacturers can make us buy they don't mind if our purchases become "white elephants."

R. S. WALLIS.

Potters Bar, Middlesex.

THE mush, fading, etc., that usually come in with the remoter stations, are so annoying, when compared with the results that the local stations give, that even those who have powerful sets soon tire of "touring."

The fact that retailers stick to the B.B.C. and records proves that the interest in Continental reception is not general.

JOHN D. WINDLE.

Southall, Middlesex.

THE letter from your correspondent "Diagnostic" calls for a protest from one foreign listener. Personally, and I can also vouch for others, the bulk of my reception comes from abroad and from non-sponsored programmes. I have no experience of commercial receivers, but here is what the W.W. A.C. Monodial Super has done as regards reception in this district during the last eight months:—

(1) Quality.—Tested by the recent B.B.C. broadcast of pure musical notes gave perfect reproduction from 50 to 5,500 cycles, with a slight fall then to 6,000 cycles.

(2) Sensitivity and selectivity.—Gives for the whole evening, free from any background noise, mush, or heterodynes, reproduction equal to London from Rome, Milan, Heilsberg, Muhlacker, Leipzig, Bero-munster, Langenburg, Trieste, Munich, Brussels I, Hilversum, Prague, and Brno. Dozens of others on which fading occasionally happens, but also here London National fades.

On this set one can listen for three to four hours at volume sufficient, if necessary, for a small hall to complete operas or orchestras. As everyone knows, the cast of the La Scala at Milan is the finest in Europe, and the A.C. Super enables one to listen to something which we can never get from the B.B.C., viz., a complete opera with the best artistes in Europe, the Berlin, Amsterdam, Stuttgart, Czech, and other Philharmonic Orchestras relayed and picked up direct, which is quite a different thing from hearing them in parts over hundreds of miles of even high-frequency cables.

A point not touched on by "Diagnostic," but in which I think the B.B.C. lags behind its foreign *confrères*, is this: A foreign station giving an international transmission gives the announcements in all the languages of the countries taking the transmission. Very seldom is this done by the B.B.C. when the Continent is taking our transmissions. It would be only courteous for us to do likewise.

Upminster.

F. CHANDLER.

AS a fairly constant listener to foreign transmissions, I should like to make a few comments. I cannot speak for persons who buy 2 H.F. sets and do not use them, but I have a set and do, and I read a German radio paper. No doubt many potential

listeners have not a separate room and set where they are able to indulge their fancy. Again, foreign interest is increased where one has travelled and understands a number of languages (the announcements, at any rate). Still, there is plenty to hear without speech. Just before reading "Diagnostic's" letter I had been listening to a lecture from Heilsberg on Hayden's musical clocks. Amusingly, the lecturer kept on playing records of which not a sound was audible, and then coming back to the "mike" and referring to them! As I am writing Warsaw has been playing Chopin's works, and has gone into a jolly interval signal. We do not listen to foreigners because they are "better" but because they are different. I never listen to B.B.C. plays, vaudeville, sport, rarely dance music, rarely debates, so I have plenty of spare time. I have just bought a record of the Comedien Harmonists played recently by Reykjavik, and am looking out for a peculiar "mocking" one played this week by Stockholm.

Certainly there is an exasperating amount of Morse interference and fading, but one just has to bear it as one of the ills. The continuous whistle nuisance can be lessened by moving the head slightly into a nodal or silent point.

H. E. ADSHEAD.

Great Bardfield, Braintree.

I WAS most interested to read "Diagnostic's" letter under the heading of "What Does the Public Want?" in your issue of January 27th. While I do not pretend to speak for the ordinary wireless enthusiast, whether technical or otherwise, I certainly consider "Diagnostic's" comment on what is usually considered the most important function of a receiver, namely, the recep-



A CRITICAL MOMENT A scene in the Leipzig studio, where the lady announcer awaits the striking of the gong, which is actuated by a clock.

tion of foreign stations, is very definitely called for so far as musicians and technically educated music lovers are concerned. It is only within the last two or three years that we musicians have seriously considered the importance of radio as a means by which we can indulge in listening to, and studying, our art.

The trouble was that, up to that time, reproduction was so poor from a musical point of view that what was not actually lost in transmission was distorted to a degree that made it impossible for a musician to listen without being decidedly repulsed. However, now the story is very different, and the reproduction of the B.B.C. Symphony Concerts, chamber music, etc., can surpass even that of the gramophone, and thus we are able to listen to performances which can be a very excellent sub-

stitute for the real thing. I use the word "can," since good reproduction is the characteristic only of expensive instruments. On the other hand, to listen-in to foreign stations with the exception of perhaps one or two is still hardly worth the while of musicians, for, in the first place, apart from interferences, the reception is of a very definitely low standard, and, in the second, foreign programmes do not offer us, outside special occasions, programmes that are any better than those provided by the B.B.C.

It must be remembered that the musician will only turn to a foreign station (1) because he wants to hear some work, either new or old, that is rarely or never performed in this country; (2) he is anxious to hear one of the great foreign orchestras, such as the Berlin Philharmonic, to compare technically with our own orchestras, such as the B.B.C. and the London Philharmonic. It goes without saying, therefore, that, unless the reproduction is first-rate, he will only get a distorted and untrue idea of what he wants to listen to, with the result that he has merely wasted valuable time.

I know many musicians who have refused to purchase a wireless set as they are unable to find anything at a figure which they are able to afford and which at the same time will give a colourable imitation of the real thing.

In short, an instrument that will not reproduce a faithful representation is useless for any programme, from a musician's point of view. I know that it can be done. Therefore surely commercial sets could be manufactured to produce real music at a cheaper figure by the sacrifice of some of their distance-getting properties. I, as a musician, know that were this possible a very ready sale would ensue.

RALPH HILL, Editor.

The Musical Mirror and Fanfare.

SURELY your correspondent, "Diagnostic," overrates the difficulties of the set designer in his letter in the issue of January 27th? It is not really a question of listeners who want only local stations and quality, or another group who must have foreign stations all the time. The real standard for a set is, will it provide, at almost any time, a suitable alternative programme, British or Continental? If one wishes to hear opera and the B.B.C. is not providing it at that time, the loss of some quality matters little. The real demand is for the type of transmission one prefers, at the right moment.

The "distance fiend" can look after himself. The *Wireless World* has given him ample choice of circuits he can assemble, and I think he is usually independent of the set manufacturer.

Anyhow, the problem is no more difficult than that of the manufacturer of motor cars, yet he does not try to pin all his clients down to comfortable "tourers."

In conclusion, may I say how I appreciate the way your magazine has developed, still ahead with design but much easier to understand than it used to be.

I particularly like the lucid articles by Mr. Scroggie. Could he give us more information on the control of bass resonance in parallel-fed L.F. couplings, another article on accurate matching of set and speaker, and possibly some one to deal with the use of quiescent push-pull and small H.T. units?

"INTERESTED."

Newcastle-on-Tyne.

Correspondence—

YOUR correspondent "Diagnostic" has spoken nothing but the truth, though he has probably put the cat among the pigeons so far as your readers are concerned. But then your readers are not typical of the great bulk of wireless listeners to whom everything "inside the box" is a sealed book. I do not number among my many friends more than one regular listener to foreign stations. The rest of us agree with "Diagnostic." On the odd occasions when the B.B.C. has an off night we usually switch off altogether. We simply cannot tolerate fading, atmospheric, interference of any kind or the ghastly hiss of the powerful de luxe receiver when reaching out. We do not even listen to Daventry because the quality is so poor, nor do we listen to a land-line programme if there is an equally attractive one from the local studio.

A high-class two-station receiver would only deprive us of Radio Paris on Sunday afternoons and during Test matches—probably it "never would be missed." I feel sure that if some enterprising manufacturer would put on the market a range of two-station receivers he would have an immediate success.

Manchester. "TWO-WAY SWITCH."

The B.B.C. Organ

AS the builders of the new B.B.C. organ, may we be allowed to comment on the remarks made in "Broadcast Brevities" in your issue dated January 27th?

We are anxious for your readers to know that the organ will contain absolutely nothing "which would make an ordinary (or extraordinary) organ enthusiast go queasy"! There will definitely be no "effects" such as drums, glockenspiel, and the like—nothing but pure organ tone of the best kind human hands can produce. This will be a large concert organ, capable of playing anything written for the organ or transcribed for it from orchestral scores.

We are not ashamed of our cinema organs—in fact, we are proud to have contributed largely to the popularity of this type of instrument by installing such a large number. The tremulant, the vox humana, the swell pedals, and all the special effects have their uses and can equally well be abused, like all good things. But the Broadcasting House concert hall is no place for a theatre organ, and any "performer who wishes to beat the cinema organ at its own game" on our organ there will have a bitter disappointment.

We are sure your readers will sympathise with us in trying to live down the huge success of our cinema organs in an attempt to maintain our reputation as builders of cathedral, church, and concert organs.

Willesden, N.W.10. J. I. TAYLOR,
Director, The John Compton
Organ Co., Ltd.

Quiescent Push-pull

I WISH to congratulate you on bringing to light the valuable properties of quiescent push-pull, at a time when concentration on mains-drive tends to leave the battery user in neglect.

As announcements of manufacturers have described it as a "new principle," I would draw attention to the fact that a quiescent push-pull receiver of my design, with an output of 1,500 milliwatts and an initial anode current of 8 mA., was put on the market as the Burndept Universal Five (battery model) three years ago.

London, S.E.19. M. G. SCROGGIE.

In Next Week's Issue:—

The MODERN A.C. QUALITY AMPLIFIER

A Self-contained Gramophone Equipment with Electric Motor, Pick-up and Amplifier giving 5 to 6 watts Undistorted Output

FEW sounds are more distressing than those emanating from an over-worked loud speaker or amplifier, yet the phenomenon is not a rare one. Too often an equipment entirely suitable for domestic use is pressed into service at a party or similar function and is expected to entertain some hundreds of people just as successfully as it would a few friends at the fireside.



The amplifier shown separate from the cabinet. The synchronous electric motor, pick-up and the two controls are attached to the motor board.

LIST OF PARTS REQUIRED

After the particular make of component used in the original model, suitable alternative products are given in some instances

- 1 Mains transformer, 400-0-400 v. Savage type M.G.A. 4 volts 3 amps, centre tapped; 4 volts 2 amps; 4 volts 1 amp., centre tapped. (R.I. Sound Sales, Varley)
- 1 Output choke Savage "Massicore" type L.34 (R.I. Sound Sales, Varley)
- 1 L.F. choke, 28/14 henrys R.I. type DY.11 (Varley)
- 1 L.F. transformer, 4:1 Multitone "Toco"
- 1 Graded potentiometer for above Multitone
- 1 Combined potentiometer, 100,000 ohms and mains on-off switch British Radiophone type 484 (Belgin, Claude Lyons, Rotorohm, Lewcos, Watmel, Wearite)
- 1 Power resistance, 3,000 ohms, 10 watts Varley C.P.30 and holder
- 1 Resistance, 100 ohms, 1 watt Claude Lyons
- 1 Resistance, 500 ohms, 1 watt Claude Lyons
- 1 Resistance, 1,000 ohms, 1 watt Claude Lyons
- 1 Resistance, 5,000 ohms, 1 watt Claude Lyons
- 1 Resistance, 10,000 ohms, 1 watt Claude Lyons
- 1 Resistance, 50,000 ohms, 2 watts Claude Lyons
- 1 Resistance, 500 ohms, 3 watts Claude Lyons (Dubilier, Eric)
- 1 Potentiometer, 30 ohms Claude Lyons "Humdinger"
- 4 Valve holders, 5-pin Clix chassis mounting type (Belgin, Eddystone, W.B.)
- 2 Fixed condensers, 1 mfd., 250 volts D.C. working Dubilier type B.S.
- 1 Fixed condenser, 2 mfd., 250 volts D.C. working Dubilier type B.S.
- 1 Fixed condenser, 4 mfd., 350 volts D.C. working (Peak, T.C.C.) Dubilier type L.S.B.
- 3 Fixed condensers, 4 mfd., 500 volts D.C. working T.C.C. type 95
- 1 Fixed condenser, 0.1 mfd., 350 volts D.C. working (Dubilier, Peak) T.C.C. type 84
- 1 Combined twin fuse holder and Mains Connector, complete with two 1-amp. fuses Bulgin type F.15
- 9 Ebonite shrouded terminals, Earth, 3 L.S., 3 L.S., 2 Pick-up Belling-Lee type "B" (Burton, Clix, Elex, Igranic)
- 1 Plymax baseboard, 18x9x1/2 in. Peto-Scott
- 2 Battens, drilled, 18x1 1/2 in. Peto-Scott
- 2 Battens, 8 1/2 x 1 1/2 in. Peto-Scott
- 1 Metal cowl Peto-Scott
- 1 Gramophone motor unit B.T.H. "Truspeed"
- 1 Pick-up Marconiphone K17
- Cabinet, 19x15x14 1/2 in. Peto-Scott
- 2 lengths Screened sleeving Goitene (Harbros, Lewcos)
- 8 lengths Systoflex, flex, etc.
- 1 Vacuum thermal delay switch Ediswan D.L.S.1
- Screws: 22 1/2 in. No. 4 R/hd.; 22 1/2 in. No. 6 R/hd.; 8 1/2 in. No. 6 R/hd.; 6 1/2 in. No. 4 R/hd.; 2 1/2 in. No. 6B.A.
- Valves: 1 Marconi or Osram MHL4 metallised, or Mazda AC/HL. 1 Marconi or Osram PX25 or Mazda PP5/400, 1 Marconi or Osram U.14 or Mazda UU.120/500.

BLUE PRINTS

As mentioned elsewhere in this issue, blue prints for "The Wireless World" All-Wave Monodial Super (Battery) are obtainable, price 1s. 6d. post free. In addition, blue prints are available for the following:—

- Autotone. (February 24th, March 2nd and 9th, 1932.)
- Monodial A.C. Super. (Booklet, price 1s. 8d. post free.)
- Modern Straight Five. (June 22nd and 29th, 1932.)
- Baby Superhet, A.C. (August 19th and September 2nd, 1932.)
- Baby Superhet, Battery. (October 7th, 1932.)
- Short Wave Two. (November 4th and December 23rd, 1932.)
- Monodial D.C. Super. (December 2nd and 9th, 1932.)
- Straight Three. (December 16th, 1932.)
- Modern D.C. Three. (December 30th, 1932, and January 6th, 1933.)

These can be obtained, price 1s. 6d., from the Publishers, Hiffe & Sons, Ltd., Dorset House, Tudor Street, London, E.C.4.

Undoubtedly there does exist to-day a large demand for an ambitious gramophone equipment capable of delivering up to 6 watts speech. This demand is fulfilled by the "Modern A.C. Quality Amplifier" which consists of two L.F. stages, the interval coupling being a transformer with variable tone control. To safeguard condensers and other equipment from high initial voltages a vacuum thermal delay switch is incorporated and each stage is thoroughly decoupled.

There is provision in the smoothing circuit for energising two loud speaker fields so that dual-compensated units can be used within any reasonable distance from the amplifier.

READERS' PROBLEMS

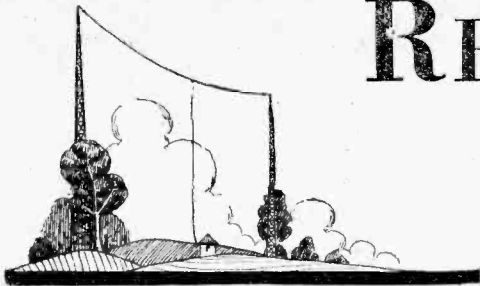

A Universal Station Finder

WE are asked to say whether *The Wireless World* Station Finder could be modified to give identification both by the absorption principle (as in the original instrument) and also by the addition of a buzzer, as a radiating wavemeter. Our querist has made up the device as described, and now wishes to extend its usefulness by converting it into a generator of signals of known wavelength as an aid to fault-finding, ganging, and general receiver adjustments.

This is quite a practical plan, and the cost of having a buzzer—which will only amount to a few shillings—is well justified if the Station Finder is required to do anything more than perform the functions for which it was originally designed. Full information regarding the addition of a buzzer was given last week, but in order that the instrument may be made to serve either as an absorption or a radiating meter

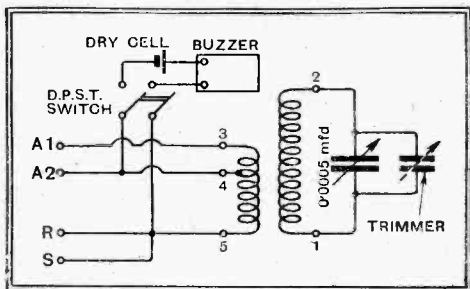

Fig. 1.—Indication by absorption or radiation at will: a de luxe version of the station finder.

at will, we suggest that it should be wired as shown in Fig. 1. With the double-pole single-throw switch in the "open" position, the meter may be connected in the aerial circuit in the usual manner. By closing the switch the buzzer is put into operation, but before doing this the instrument should be entirely disconnected from the receiver.

When the instrument is used as an aid to making critical adjustments, it is worth while taking a little extra trouble in adjusting the buzzer, so that the amplitude of the oscillations which it produces in the tuned circuit may remain sensibly constant.

Potentiometer Resistance Values

WHEN a potentiometer is used to control the grid voltage of a battery-fed variable- μ H.F. valve, it is normally connected across the grid bias battery, and so will draw current from it. The actual value of the potentiometer is seldom a matter of any great importance, the main requirement being that its ohmic resistance will be sufficiently high to prevent an undue wastage of current.

A potentiometer of about 25,000 ohms is very often specified. This happens to be a standard value obtainable almost every-

THESE columns are reserved for the publication of matter of general interest arising out of problems submitted by our readers. Readers requiring an individual reply to their technical questions by post are referred to "The Wireless World" Information Bureau, of which brief particulars, with the fee charged, are to be found at the foot of this page.

where, and is perhaps rather more dependable than a component of higher resistance. Connected across a 9-volt battery, for example, the current consumed by a potentiometer of this resistance will amount to only about a third of a milliampere, and so the life of the battery will not be greatly less than if it were working under "no load" conditions. Of course, measures are always taken to interrupt the battery circuit when the set is out of use.

To those correspondents who have written to us on the subject, we would say that when it suits them to do so, there is little reason why they should not use potentiometers of, say, half or twice the value specified. But if there happens to be a bias-limiting resistance in series with the potentiometer, the value of this resistance should be increased or reduced proportionally. For instance, if a 25,000-ohm potentiometer is recommended in a certain design, together with a limiting resistance of 2,000 ohms, a change in potentiometer resistance to 50,000 ohms would imply the use of a "limiter" of 4,000 ohms. The nearest standard value of 5,000 ohms would be satisfactory.

25-cycle A.C. Mains

WE have recently received several requests for advice on the subject of operating recently described *Wireless World* receivers on 25-cycle A.C. mains.

The position may be briefly summed up by saying that almost any A.C. set may be made to work satisfactorily with a supply system of that low periodicity, but, of course, a specially designed power transformer must always be used. Incidentally, the transformer is bound to be larger than one intended for standard 50-cycle supplies, and so slight modifications in the original layout may become necessary. It may also be necessary to change the relative positions of the power transformer and L.F. transformer in order to minimise hum.

The Wireless World INFORMATION BUREAU

THE service is intended primarily for readers meeting with difficulties in the construction, adjustment, operation, or maintenance of wireless receivers described in *The Wireless World*, or those of commercial design which from time to time are reviewed in the pages of *The Wireless World*. Every endeavour will be made to deal with queries on all wireless matters, provided that they are of such a nature that they can be dealt with satisfactorily in a letter.

Communications should be addressed to *The Wireless World* Information Bureau, Dorset House, Tudor Street, E.C.4, and must be accompanied by a remittance of 5s. to cover the cost of the service. The enquirer's name and address should be written in block letters at the top of all communications.

There is also the question of smoothing. Theoretically, a considerably more generous smoothing system will be required, but in practice the ordinary smoothing circuit may be quite effective; this is because both the loud speaker and the human ear are less sensitive to the lower hum frequencies of the 25-cycle supply. It is therefore recommended that additional smoothing condensers—and possibly an extra choke—should not be added until they are found to be necessary.

Measuring "Free" Bias

WITH an ordinary voltmeter it is practically impossible to make an accurate measurement of the voltage applied from an automatic grid-bias system. The degree of error depends on such factors as the resistance of the meter and the value of the bias resistor.

With a valve voltmeter it is possible to make a direct and accurate measurement, but very few amateurs have access to this piece of apparatus. As a rule, one must be satisfied with an indirect estimation of voltage, which is obtained by measuring the current flowing through the bias resistor and then calculating the voltage that will be developed across it.

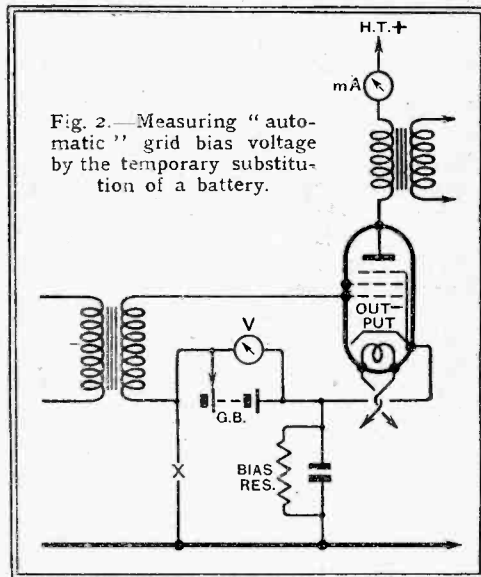

Fig. 2.—Measuring "automatic" grid bias voltage by the temporary substitution of a battery.

In the absence of special appliances, a measurement of bias voltage can only be made by a method of substitution, and this is the plan that we recommend to a reader, who has a multi-range milliammeter and a voltmeter. Briefly, what we recommend him to do is to insert the milliammeter in series with the anode of the valve (in this case the output valve) and to substitute temporarily a bias battery for the original automatic system. The voltage of this battery will then be varied until the same anode current flows as under normal automatic bias conditions. The voltage of the bias battery, as measured by a good voltmeter, will then be equal to that originally applied.

Connections will be as shown in Fig. 2; the original grid return lead must be interrupted at the point X, and the positive side of the bias battery must be joined directly to the cathode of the valve.

The Wireless World

THE
PRACTICAL RADIO
JOURNAL
22nd Year of Publication

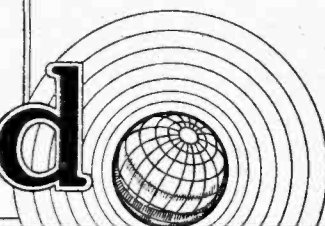
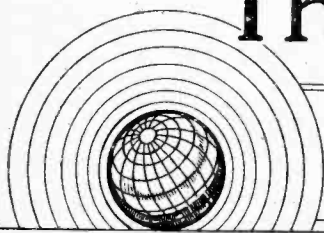

No. 703.

FRIDAY, FEBRUARY 17TH, 1933.

VOL. XXXII. No. 7.

Proprietors: ILIFFE & SONS LTD.

Editor:

HUGH S. POCOCK.

Editorial Offices:

116-117, FLEET STREET, LONDON, E.C.4.

Editorial Telephone: City 9472 (5 lines).

Advertising and Publishing Offices:

DORSET HOUSE, TUDOR STREET,

LONDON, E.C.4.

Telephone: City 2846 (17 lines).

Telegrams: "Bthaworld, Fleet, London."

COVENTRY: Hertford Street.

Telegrams: "Cyclist, Coventry."

Telephone: 5210 Coventry.

BIRMINGHAM:

Guildhall Buildings, Navigation Street, 2.

Telegrams: "Autopress, Birmingham."

Telephone: 2970 Midland (3 lines).

MANCHESTER: 260, Deansgate, 3.

Telegrams: "Iliffe, Manchester."

Telephone: Blackfriars 4112 (4 lines).

GLASGOW: 26B, Renfield Street, C.2.

Telegrams: "Iliffe, Glasgow." Telephone: Central 4837.

PUBLISHED WEEKLY. ENTERED AS SECOND CLASS MATTER AT NEW YORK, N.Y.

Subscription Rates:

Home, £1 1s. 8d.; Canada, £1 1s. 8d.; other countries abroad, £1 3s. 10d. per annum.

As many of the circuits and apparatus described in these pages are covered by patents, readers are advised, before making use of them, to satisfy themselves that they would not be infringing patents.

CONTENTS

| | Page |
|---|------|
| PROGRAMMES FROM | |
| ABROAD, pp. I—XXIV | |
| Editorial Comment | 127 |
| The Modern A.C. Quality Amplifier | 128 |
| Practical Hints and Tips | 132 |
| News of the Week | 133 |
| Automatic Volume Control | 134 |
| Parallel-Feed Precautions | 137 |
| Broadcast Brevities | 139 |
| Majestic Earlswood Receiver | 140 |
| Letters to the Editor | 142 |
| New Apparatus Reviewed | 143 |
| Readers' Problems | 144 |

EDITORIAL COMMENT

Headlines for the B.B.C.

Wake Up the Announcers!

IF we opened our daily paper one morning and found no headlines to any article and the same size type throughout, we should undoubtedly regard it as dull in appearance and be annoyed at the difficulty we should experience in sorting out news or items of importance from what was trivial in character.

In the case of broadcasting, it is upon the announcers that the responsibility devolves for presenting the news or prefacing the various features of the programme, and whilst we should not like the announcements to be exaggerated in character, yet we heartily deplore the present monotonous manner in which both news and announcements are given out. If the announcer is so overworked that he is too tired to put any enthusiasm into his introductions, then, naturally, he must have our sympathy, but we suspect that it is not the fault of announcers individually but a part of their training that they should make their announcements in this mechanical fashion. Last week when in the news we were informed of the magnificent achievement of the R.A.F. flyers in breaking the distance record in their flight to the Cape, the announcer's delivery was so sad and monotonous that we could be excused for fearing, at first, that the flyers had met with disaster instead of success. Surely it was an occasion when the B.B.C. could have put a headline into the news and the announcer have let himself go with a little enthusiasm over so magnificent an achievement.

This general monotony in announcements pervades the whole of the programmes of the B.B.C., and we feel strongly that however desirable the B.B.C. may feel it to be to take pre-

cautions to suppress irresponsibility on the part of announcers, yet something should be done to eliminate the "weariness" from the announcers' tones and an effort made to put headlines of bold type in their proper perspective in the prefaces to the news and programme items.

Inter-Nation Broadcasts

Success of an Initial Effort

WE congratulate the B.B.C. and the N.B.C. of America on the enterprise shown in organising the successful debate last Saturday between Yale and Cambridge on the subject of War Debts and Reparations.

The idea of this debate fits in admirably with the suggestions put forward by us in a Leader included in our issue of February 10th. In the case, however, of this debate a common language was employed. Our suggestions included talks in English from Continental stations and from the British stations in Continental languages.

Those who may have listened last week to the broadcast of a speech by Herr Hitler must have been impressed with the interest that this speech would have aroused amongst English listeners if it had been more generally understood.

What is needed in Europe to-day is for nations to understand each other's peculiar aspirations and ideals and to have some appreciation of individual national problems, in order to be sympathetic and understanding when these problems are discussed. We do not believe that the ordinary channels of communication can be as effective in achieving this result as broadcast talks, and it is for this reason that we hope the interest in the debate on war debts will encourage the B.B.C. to further efforts.

The MODERN A.C. QUALITY AMPLIFIER

A Self-contained Gramophone Equipment giving 5 to 6 watts Undistorted Output

By W. I. G. PAGE, B.Sc.

TO people who have grown up with the gramophone and have heard it through the vicissitudes and paroxysms of earlier years, it may be difficult to realise how nearly perfection has been reached in the modern electric reproduction. To the advantages of electrical recording are added those of the modern electric amplifier, an example of which it is the purpose of this article to describe. It can be seriously argued that the time has now come when a good gramophone amplifier with generous power output can be more satisfying than a small amateur orchestra.

In the Modern A.C. Quality Amplifier no pains have been spared to secure a faithful rendering of the original, and a flexibility of control has been arranged to suit the different character of the records played and the varying tastes of a large audience.

It is through the introduction of the 25-watt output valve, giving 5 to 6 watts

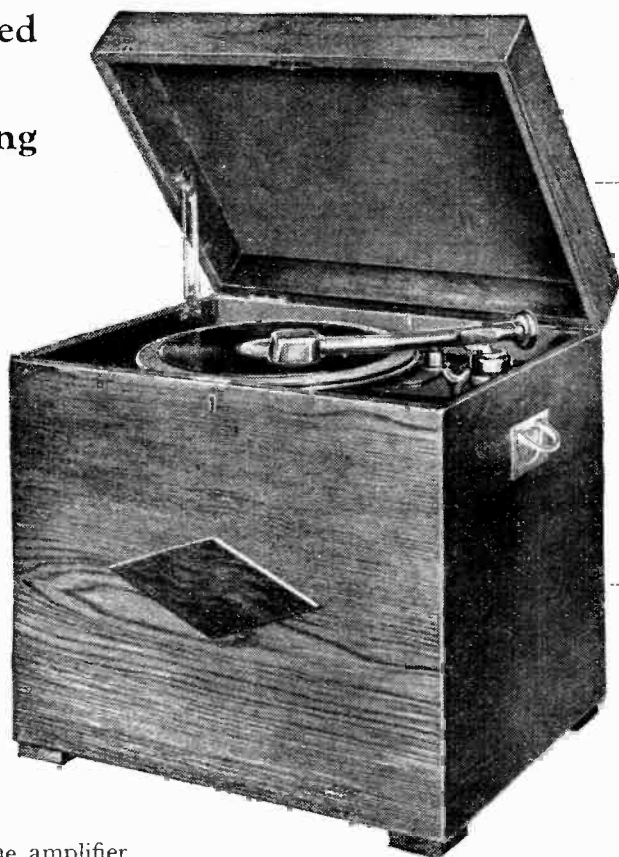

FEATURES:

The equipment comprises a two-stage amplifier housed in a cabinet containing a synchronous gramophone motor, turntable and pick-up. The L.F. intervalve coupling consists of a transformer with continuously variable tone control. To safeguard condensers and to economise in equipment a vacuum thermal delay switch is incorporated and instability is guarded against by thorough decoupling. There is provision in the smoothing circuit for energising two loud speaker fields so that dual compensated units can be used. If desired, a record changer can take the place of the synchronous motor.

the woodwork to warp. Free circulation of air round the valves is assured in the amplifier being described by a curved metal cowl from which convection currents are diverted through the metal grille at the back of the cabinet; furthermore, the base of the cabinet and the baseboard and battens of the chassis have a number of large holes drilled in them.

The amplifier equipment, which is transportable, will, when working at full volume level, be capable of entertaining quite 300 people in a concert hall or of providing music for 200 people dancing; on the other hand, it can be tamed to give less than 1 watt (A.C.) if an occasion arises to use it in an ordinary living room.

The amplifier is built on a metal-covered baseboard measuring 18 ins. by

speech, that the construction of an ambitious amplifier delivering "Public address" volume comes within the scope of the amateur. Little deviation from the conventional layout used for much smaller amplifiers need be made. There is, however, the question of ventilation, as the heat developed by the large output and rectifying valves is liable in a self-contained gramophone equipment to dry the bearings of the electric motor and to cause

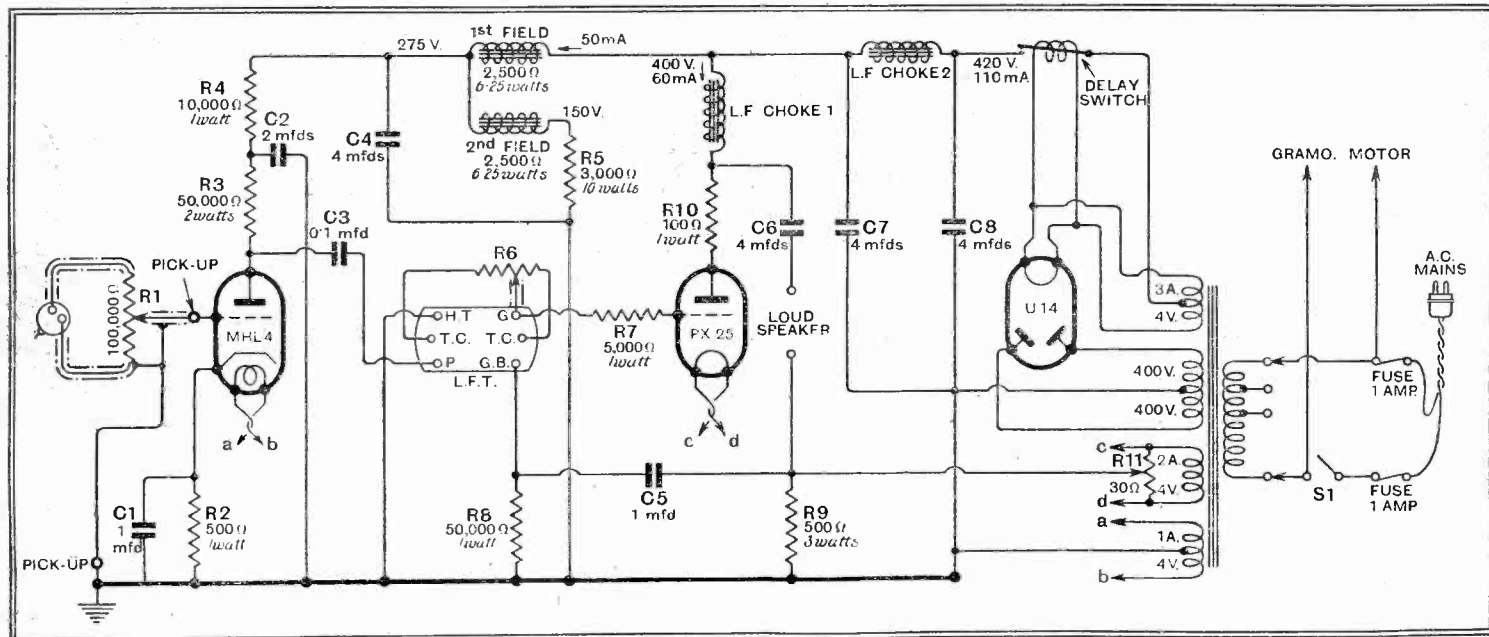

The complete circuit diagram. The potentiometers R1 and R6, controlling respectively volume and tone, are mounted on the front of the motor board to the right and left of the turntable. The switch S1 is integral with the potentiometer R1.

The Modern A.C. Quality Amplifier—

9 ins. by $\frac{3}{4}$ ins. standing on four battens each $1\frac{1}{4}$ ins. deep. The chassis is housed in the base of a large cabinet, the upper compartment of which forms the motor board, and to this is attached the B.T.-H. "Truspeed" synchronous motor, the

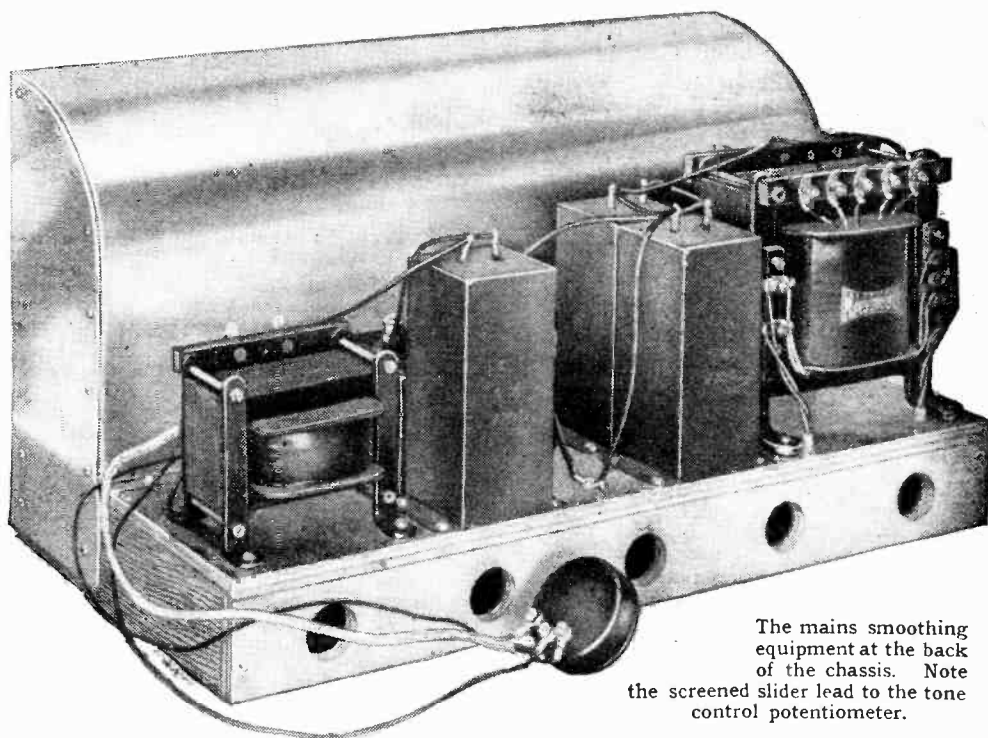

The mains smoothing equipment at the back of the chassis. Note the screened slider lead to the tone control potentiometer.

Marconiphone pick-up, and the two control potentiometers. A lid of substantial proportions is provided so that, when closed, needle chatter cannot be heard during the playing of a record. Looking at the front of the unit the left-hand potentiometer controls the tone—the interval coupling being effected by a Multitone transformer with centre-tapped windings, while the right-hand control shunted across the pick-up adjusts volume, and when rotated to its extreme anti-clockwise position, open-circuits the mains input, cutting off both the amplifier and the motor.

Dual Speakers

It is felt that with an amplifier having such a large output the speaker or speakers (if two be employed) should not be built-in to the cabinet, and their location should be left to the discretion of the constructor. It is often an advantage to have baffles mounted in the corner of a hall near the ceiling; especially is this the case when music is required for dancing. There are undoubted advantages in using dual speakers, where the output is over, say, 3 or 4 watts, for not only is the volume level increased, but a better frequency response is obtained and the bass is especially well rendered. Bearing this in mind, the smoothing equipment of the amplifier has been designed to include two loud speaker field windings in series, each of 2,500 ohms D.C. resistance, and as the voltage distribution scheme allows 50 mA. to flow through them—an adequate dissipation of 6.25 watts is obtained in each.

Dual speakers, which must be mounted close together on a baffle of reasonably large area, are generally fed from one output transformer mounted on the baffle or on one of the speakers; it is therefore necessary to take only a single pair of

leads for speech currents, but each field requires a pair of leads, accounting for a total of six wires between amplifier and speaker unit. No instability or hum was produced when these leads, as twisted pairs, were run a few inches apart for a distance of 25 to 30 feet.

From the circuit diagram it will be seen that there is applied to the output valve a

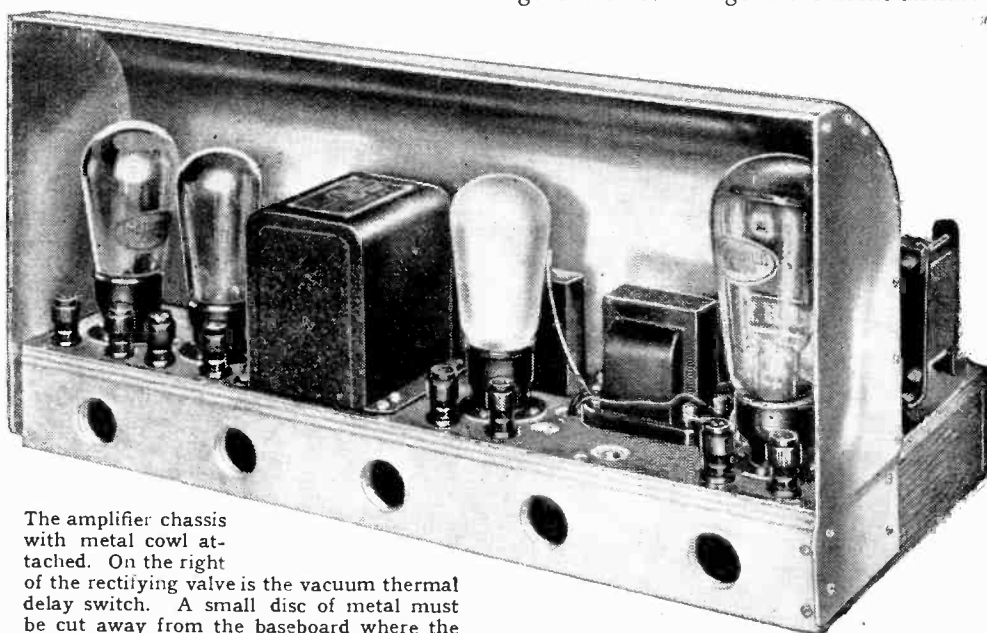

The amplifier chassis with metal cowl attached. On the right of the rectifying valve is the vacuum thermal delay switch. A small disc of metal must be cut away from the baseboard where the Humdinger is brought through.

little less than 400 volts, although the first valve does not really need much over 120 volts H.T. to accommodate the output of the Marconiphone pick-up. Unless certain expedients are resorted to, this dis-

parity of voltage requirements will force the designer to include high-voltage condensers in that part of the set associated with the first valve. These condensers will have to carry with safety the high voltage applied during the 25 seconds while the heater of the indirectly heated valve is warming up.

Quite a large number of condensers are involved, and to avoid heavy cost, and, incidentally, considerable extra baseboard space, either a separate low-voltage rectifier must be used for the first valve or a thermal-delay switch interposed in the main positive H.T. lead. The second of these has been considered the most practicable, and the Ediswan vacuum switch—type D.L.S.I.—has been chosen. This component resembles a valve and consists of a bi-metal contact strip assembly mounted in a glass bulb with a 4-pin base, and connections must be made so that the input is joined to the grid pin and the output to the anode pin. The time delay can be varied by change of heater temperature, but with four volts, contact is made after 30 seconds, which is entirely satisfactory. The heater consumption under these conditions is 0.5 ampere.

Voltage Distribution

The general circuit is quite straightforward and components having a large margin of safety have been chosen. The mains are led to an adaptor unit screwed to the inside wall of the cabinet. Two 1-ampere fuses are included here, and connection is then made via the switch S.1 (integral with R1) to the motor and the primary of the mains transformer. The latter has an incremental tapping of 10 volts so that all voltages between 200 and 250 can be accommodated. The general D.C. voltage and current distribu-

tion is shown on the circuit diagram. With a load of 60 mA. for the output valve and 50 mA. for the speaker fields together with R5, an initial unsmoothed voltage of 420 is found across C8. The main smoothing choke drops about 20

The Modern A.C. Quality Amplifier—

volts, leaving 400 volts to feed the anode circuit of the PX25 and the two speaker fields. Each field causes a drop of 125 volts, so 150 volts is left to be absorbed in the resistance R5. No account has been taken of the small current passed by the MHL4 valve as this forms a negligible part of the total.

Separate heater windings for the two valves have been arranged on the mains transformer so as to facilitate automatic bias. To the grid and anode terminals of the output valve holder are connected anti-parasitic oscillation resistances R7 and R10, which prevent unwanted high-

BLUE PRINTS

For the convenience of readers constructing this Amplifier, full-sized blue prints of the complete layout and wiring diagram are available from the publishers at 1s. 6d. post free.

frequency disturbances. The grid circuit is decoupled by R8 C5 and automatic bias is provided by the 3-watt resistance R9. An intervalve transformer with a continuously variable tone control potentiometer (R6) has been chosen, as it is found that by its use the output can be adjusted to suit various acoustic surroundings. Sometimes speech is more

natural if the tone is raised above the level found best for music, and there are some records with which it is a great advantage to bring up the bass register. The curves reproduced show the response (1) when the potentiometer is turned to the extreme bass position; (2) the midway position, and (3) full treble response. The voltage amplification on the vertical scale is that given by an MHL4 valve working into a load of 50,000 ohms. Although parallel-fed, the transformer is not auto-coupled, thus grid decoupling of the succeeding valve is fully effective.

Little need be said of the input circuit and valve. Anode decoupling is given by

PRACTICAL WIRING PLAN AND DIMENSIONAL DATA

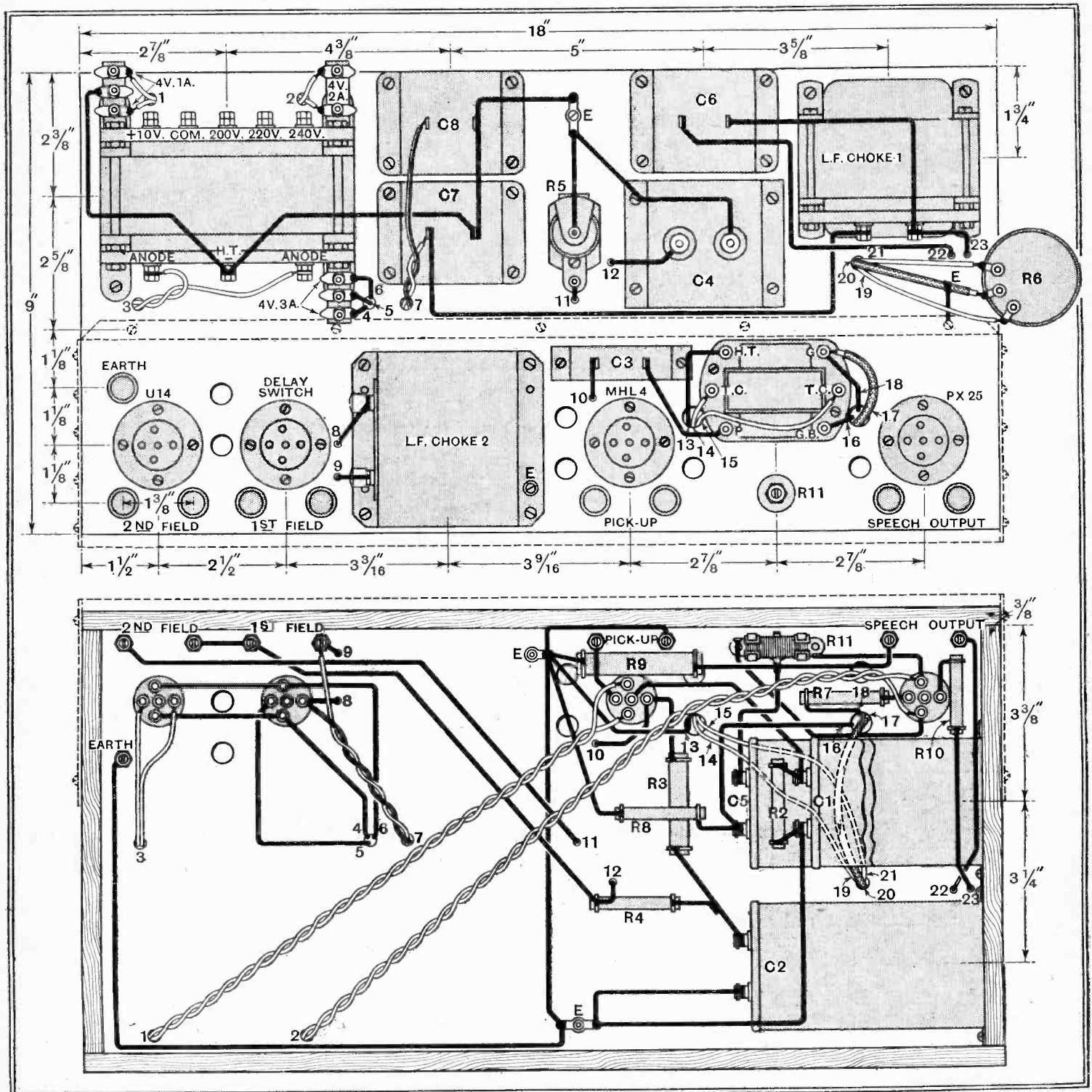

The volume control and mains on-off switch are mounted on the motor board and are not shown.

The Modern A.C. Quality Amplifier—

R4 C2, and adequate protection from electrostatic pick-up is afforded by earthing the motor and using earthed screened leads for the sliders of R6 and R1, the metal braiding of the lead in the latter case being used for the pick-up return circuit. The connections for the pick-up terminals mounted on the baseboard of the amplifier should be clear from the circuit diagram. The bias resistance R2 of 500 ohms will generally be found of sufficiently high value, but with pick-ups having an exceptionally large peak output, a value of 1,000 ohms may be necessary.

The gramophone motor chosen is of the synchronous type and is self-starting, and the correct speed is maintained exactly if the mains are frequency-controlled. An adjustable automatic stop is provided, which is found to give consistent and positive operation with the different types of run-off groove. The distance between the lid of the cabinet and the motor board, also the clearance above the cowl in the amplifier, have been made large enough to accommodate a Garrard record changer which has a permanent pick-up.

LIST OF PARTS REQUIRED

After the particular make of component used in the original model, suitable alternative products are given in some instances

- 1 Mains transformer, 400-0-400 v. Savage type M.C.A. 4 volts 3 amps, centre tapped; 4 volts 2 amps; 4 volts 1 amp., centre tapped. (R.L. Sound Sales, Varley, Vortexion, Trix)
- 1 Output choke, LFC1 Savage "Massicore" type L.34 (R.L. Sound Sales, Varley, Trix)
- 1 L.F. choke, 28 1/4 henrys, LFC2 R.L. type DY.11 (Varley, Trix)
- 1 L.F. transformer, 4:1, LFT Multitone "Toco"
- 1 Graded potentiometer for above, R6 Multitone
- 1 Combined potentiometer, 100,000 ohms and mains "on-off" switch, R1, S1 British Radiophone type 484 (Bulgin, Claude Lyons, Rotorohm, Lewcos, Wabmel, Wearite)
- 1 Power resistance, 3,000 ohms, 10 watts, R5 and holder Varley C.P.39
- 1 Resistance, 100 ohms, 1 watt, R10 Claude Lyons
- 1 Resistance, 500 ohms, 1 watt, R2 Claude Lyons
- 1 Resistance, 5,000 ohms, 1 watt, R7 Claude Lyons
- 1 Resistance, 10,000 ohms, 1 watt, R4 Claude Lyons
- 1 Resistance, 50,000 ohms, 2 watts, R3 Claude Lyons
- 1 Resistance, 500 ohms, 3 watts, R9 Claude Lyons (Dubilier, Erie)
- 1 Potentiometer, 30 ohms, R11 Claude Lyons "Humdinger"
- 4 Valve holders, 5-pin Clix chassis mounting type (Bulgin, Eddystone, W.B.)
- 2 Fixed condensers, 1 mfd., 250 volts D.C. working, C1, C5 Dubilier type B.S.
- 1 Fixed condenser, 2 mfd., 250 volts D.C. working, C2 Dubilier type B.S.
- 1 Fixed condenser, 4 mfd.; 350 volts D.C. working, C4 (Peak, T.C.C.) Dubilier type L.S.B.
- 3 Fixed condensers, 4 mfd., 500 volts D.C. working, C6, C7, C8 T.C.C. type 95
- 1 Fixed condenser, 0.1 mfd., 350 volts D.C. working, C3 (Dubilier, Peak) T.C.C. type 84
- 1 Combined twin fuse holder and Mains Connector, complete with two 1-amp. fuses Bulgin type F.15
- 9 Ebonite shrouded terminals, Earthing, 3 L.S., 3 L.S., 2 Pick-up Belling-Lee type "B"
- (Burton, Clix, Ealex, Igranic)
- 1 Plymax baseboard, 18x9x3/8 in. Peto-Scott
- 2 Batters, drilled, 18x1 1/2 in. Peto-Scott
- 2 Batters, 8 1/2 x 1 1/2 in. Peto-Scott
- 1 Metal cowl Peto-Scott
- 1 Gramophone motor unit B.T.H. "Trusped"
- 1 Pick-up Marconiphone K17
- Cabinet, 19x15x14 1/2 in. Peto-Scott
- 2 lengths Screened sleeving Goltone (Harbros, Lewcos)
- 8 lengths Systoflex, flex, etc.
- 1 Vacuum thermal delay switch Ediswan D.L.S.1
- Screws: 22 3/16 in. No. 4 R/hd.; 22 3/16 in. No. 6 R/hd.; 8 3/16 in. No. 6 R/hd.; 6 3/16 in. No. 4 R/hd.; 2 3/16 in. No. 6 B.A.
- Valves: 1 Marconi or Osram M114 metallised, or Mazda AC/11L or Cossor 41M11L, 1 Marconi or Osram PX25 or Mazda PP5/400, 1 Marconi or Osram U.14 or Mazda UU.120/500 or Cossor 400BU.

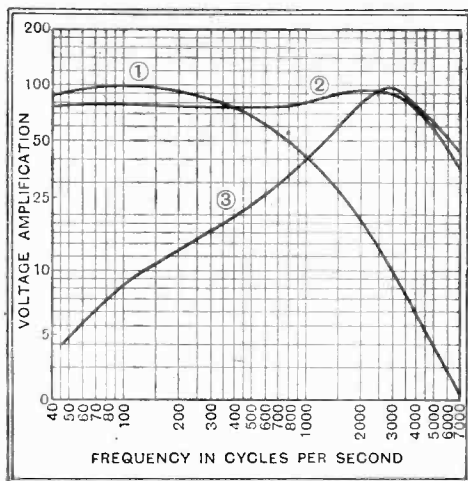

Frequency response curves of the Multitone 1 to 4 L.F. transformer. When the tone control potentiometer is turned to either extreme treble or bass, the response is given by curves 3 and 1 and an intermediate position is represented by curve 2.

The Marconiphone pick-up must be properly tracked, and the arc formed by the needle point when the tone arm is swung over the record should cut the centre of the turntable spindle.

When dual speakers are used it is important to "phase" them correctly—that is, each speech coil should be pushing and pulling simultaneously. If a wrong connection is suspected—and it will be accompanied by loss of bass and the existence of "dead" spots some yards from the

speakers—it is only necessary to reverse the leads to one speech coil. If only one speaker is used the terminals for the second field (next to R5) should be bridged by a 10-watt resistance of 2,500 ohms. Suitable dual speakers to handle up to 6 watts speech are the Sonochorde Senior Dual SR.2500; Rola Type F7M.2500 plus F62500, with OOB transformer; Magnavox type Magna DC142/144, 2500 fields plus 20500 transformer; Baker Elomag Dual (2500) and Celestion DS.28 or 88.

If reference is made to the drawings and photographs no difficulty in construction should present itself. It cannot be emphasised too strongly how important are the various earth connections to the metal covering of the baseboard. Aluminium oxidises very quickly, and unless a really tight joint is made there may be intermittent contact. It is as well to earth the amplifier, using the terminal provided.

When the building of the equipment has been completed, and the various speaker connections arranged, the only adjustments to be made (apart from the controls of tone and volume) are the "Humdinger" (R11), the automatic motor stop, the phasing of the speakers, and the correct connections on the primary of the mains transformer, remembering the 10-volt tapping if the supply is 210, 230, or 250 volts.

A gramophone equipment built to this design is available for inspection at 116/117, Fleet Street, London, E.C.4

DISTANT RECEPTION NOTES

READERS have possibly discovered for themselves that at long last the new Athlone transmitter is regularly at work. On the first night of the station's official career the quality did not appear to be too good, but this will no doubt be improved later. Trouble, though, may be experienced from Rabat, whose separation from Athlone is only 3.4 kilocycles. The Moroccan station is now using a power of 5 kilowatts, and comes through very strongly at times when Dublin is silent.

Marseilles appears to have been testing recently with greatly increased power. This station is credited officially with 1.6 kilowatts, but on several occasions lately it has been as strongly received as the 13-kilowatt Bordeaux. The French regional scheme worked out by General Ferrié is still hanging fire, for since there have been twenty-seven French Governments in the last few years, it has been impossible to find time to pass the necessary Bill. When the scheme is complete there will be a chain of some fourteen Government stations, most of them rated at 60 kilowatts. No place in France will be outside the service area of one or more of these stations.

It was announced a short time ago that a decree had been issued providing for the Government control of all transmitting stations, including those operated by private concerns and by amateurs. It is to be hoped that this marks the beginning of a new era in which some stations, such as Radio LL will cease to cause chaos by thrusting in upon unauthorised wavelengths (Radio LL is separated by only 4.5 kilocycles from Hamburg, on the one side, and Seville Union Radio, on the other), whilst others in the

lower part of the medium waveband will no longer wander with equally disastrous results from wavelength to wavelength as inclination takes them.

As the programme pages of *The Wireless World* show, the two Brussels stations are now giving us a welcome extension of programme hours at the week-ends. On Sundays both come into action at 10 a.m. instead of 12 noon, and both on Saturdays and Sundays the evening programme continues until midnight. It is understood that the lengthening of the programme hours is made possible by increased receipts from licence fees. These stations are so well received in this country, both in daylight and after dark, that we may almost count ourselves as being within their service area.

Reception of European stations continues to be remarkably good. On the long waves Huizen has shown occasional weakness, but as a rule this station can be heard well at any time when it is in operation. Warsaw's transmissions come through with immense strength. Kalundborg can be received with good volume and quality on most days, but occasionally there is interference from Morse signals.

Amongst the medium-wave stations heterodyne interference is rather more troublesome than it was a week or two ago, many stations suffering from it at times. Those which have been worst affected are Vienna, Beromünster, Paris Ecole Supérieure, Milan, Heilsberg, Turin, and Fécamp. Outstanding medium-wave stations at present are Hilversum, Bordeaux Lafayette, Breslau, Strasbourg, Lwow, Toulouse Midi, Leipzig, Katowice, Rome, Langenberg, Prague, and Budapest. D. EXER.

Practical HINTS AND TIPS

AIDS TO BETTER RECEPTION

BY the exercise of a little ingenuity the amateur will often find it possible to make use of components which are not precisely in accordance with the specification laid down for the particular circuit on which he is working. A case in point

Condensers in Series

is the use of fixed condensers in positions where the D.C. potential which they will be called upon to withstand is higher than the maker's rated working voltage.

By wiring two low-voltage condensers in series, the voltage existing across the circuit can be divided between them, and so they may be usable with safety. But, since the total effective capacity of two condensers in series cannot be as high as the actual value of the smaller, it will not as a rule be economical to use them in this way unless both are of equal capacity; the resultant value will then be half that of either condenser.

It is the purpose of this note to draw attention to a point of considerable importance, which may easily be overlooked when putting this scheme into operation.

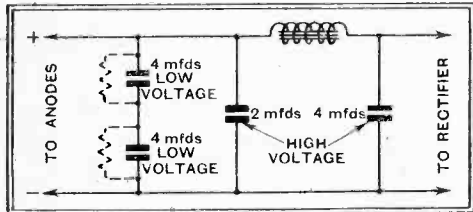

Fig. 1.—A practical case where low-voltage condensers in series may be used in a high-voltage circuit. Protective resistances, shown in dotted lines, ensure that the applied voltage shall be equally distributed.

Although the two condensers in a series combination may be of equal capacity, and have the same rated working voltage, there is no guarantee that their insulation resistance will be similar. Now the proportion of the total voltage developed across each condenser will depend upon the relative values of their insulation resistance. In fact, the two condensers form a potential divider, along which the leakage current creates voltages in proportion to the resistance.

It is a fact that the insulation resistance of nominally similar condensers can differ very considerably indeed. In order to equalise the voltages across series-connected condensers it is necessary to establish a stable potential at the junction between them, which shall be independent of the leakage current. This can be done by connecting two resistances of the same value, one in parallel with each of the condensers. It is necessary that these resistances should pass sufficient current to swamp the leakage current of the con-

densers without imposing too much additional load on the power supply system. In normal cases resistances of 1 megohm will be found suitable.

OF all the modern refinements that may be added to a long-range receiver of the more ambitious type there is surely nothing more desirable than an automatic volume control system. Various methods whereby a sensibly constant volume may be maintained, more or less independently of the strength of incoming signals, have recently

Step by Step

been described in this journal.

Many readers who are planning new sets will probably consider it essential to include automatic volume control as an integral part of the design. At the present stage of development it would perhaps be better to make provision for this addition, but to wire and test the set without it. Then, when all initial adjustments have been made and everything is working properly, the extra apparatus may be fitted and wired.

Those without previous experience of automatic volume control may excusably be puzzled by some of the effects that it introduces. In the event of a fault existing in the receiver these effects will complicate matters, and render difficult the tracing of even a minor defect. When it can be assumed that the set itself is beyond suspicion the fitting and adjusting of the control system is relatively simple.

IN many receiver designs it is usual to depend on the mounting of the ganged tuning condenser as an electrical connection for the various circuits which are controlled by the condenser. For instance, this applies to the "A.C. Monodial Superhet.," and it has been found that even a slightly imperfect connection at this point has serious results.

Chassis Connections

Among other manifestations, it introduces instability, because the resistance of the bad connection is common to several circuits.

Accordingly, care should be taken with the mounting, both from the mechanical and electrical point of view. When an aluminium chassis is employed it should be remembered that a film of insulating oxide tends to form on this metal, and so especial pains should be taken to see that any electrical connection is firmly made. In cases of doubt it is wise to supplement the mechanical mounting by an extra electrical connection made to any convenient earthed point from the condenser frame.

IT is worth while to point out that no system has ever been devised whereby the ganged tuning system of a receiver may be maintained in perfect alignment, irrespective of the capacity of the aerial with which the set is used. This is perhaps rather an academic than a practical point, as with most present-day designs imperfections in input circuit tuning, introduced by quite considerable changes in aerial capacity, are difficult to detect.

Aerial Capacity

Still, it should be borne in mind, especially when the aerial is of non-standard dimensions, or when it appears that for any reason it may have a larger or smaller capacity than usual, that the ganging of a factory-built receiver may be out of alignment. Accordingly, the trimmer of the input circuit (that which controls the tuned circuit in direct association with the aerial) may possibly be adjusted with advantage.

Wearite Whistle Suppressors

WEARITE Heterodyne Filters, specimens of which have been submitted for test, are intended primarily for connection across a loud speaker; two types are available, one removing all frequencies over 3,500 cycles, and the second over 5,000 cycles. The first is more obviously effective in suppressing the great majority of interfering whistles, but it cuts rather too deeply into the musical scale for some tastes. The second filter is especially recommended for high-quality sets, but in any case the great advantage of these units is that they may

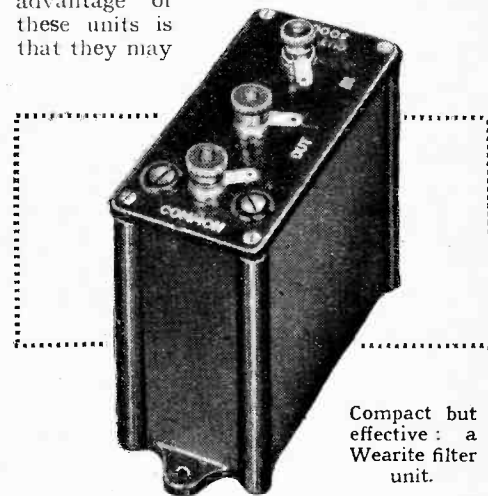

Compact but effective: a Wearite filter unit.

be easily disconnected when interference is not present.

Both models cost 10s. 6d. each; they were found to perform the function for which they are designed in an unexceptionable manner, especially with a high-impedance pentode output circuit. The makers are Wright and Weaire, Ltd., 740, High Road, Tottenham, London, N.17.

NEWS of the WEEK

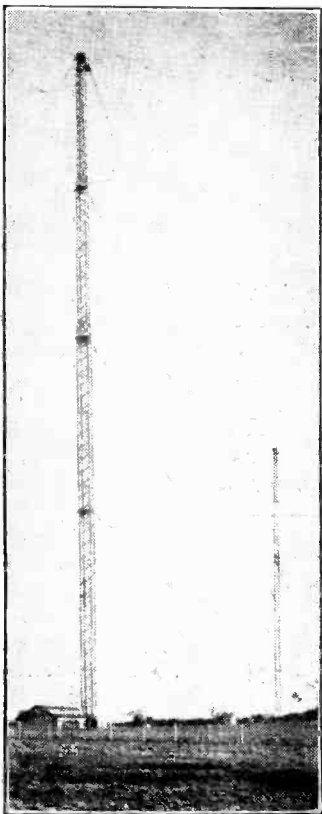

MASTS AT MOYDRUM. The aerial system of the new high-power broadcasting station of the Irish Free State. The transmitter has a power of 60kW. and was built by the Marconi Company.

Lions in their Lairs

WHERE and how Michael Faraday, Guglielmo Marconi, and other scientists made their revolutionary discoveries will be vividly demonstrated in the "Rooms of the Scientists" at the Daily Mail Ideal Home Exhibition, which opens at Olympia, London, W., on Wednesday, March 29th.

Ladies Welcomed

THERE are 232 licensed feminine radio amateurs in the world, according to the American Radio Relay League, which adds that 190 of the ladies are in the United States.

"Amateur radio has welcomed these modern Dianas of the magic telegraph key and microphone" is the League's gallant comment.

Directional Broadcasting from Vienna

THE great Austrian broadcasting station at Bisamberg, near Vienna, is already taking shape. Among its interesting features is the steel mast aerial (similar to that at Hilversum) working in conjunction with a second reflector aerial 150 yards away, which should have the effect of strengthening the radiations in a westerly direction. Vienna being in the eastern part of the country, this arrangement should produce better reception conditions in Austria and give listeners here a better chance.

Current Events in Brief Review

Radio at the B.I.F.

NO fewer than thirty-five wireless firms are exhibiting in the Hall of Music and Radio, which forms a prominent section of the British Industries Fair, opening on Monday next, February 20th, at Olympia.

No Wireless for Workless

THE Schoonhoven (Holland) Municipal Council has decided that no unemployed person may subscribe to a radio relay service or acquire a wireless set without incurring the loss of his unemployment pay.

Cause and Effect

BAVARIAN listening licences increased rapidly in number after the opening of the high-power transmitter at Leipzig on December 3rd, and the total is now 331,131. The January increase of 9,326 was approximately a third of the total increase during 1932.

Mansion as Radio Palace

BRICK by brick, each one numbered, the façade of a patrician's mansion in Amsterdam is being removed in order that the building can be transformed into a radio palace worthy of forming the headquarters of Avro, the great Dutch broadcasting association.

When the wireless apparatus has been installed in the basement, and the large rooms have been reconstructed as studios and offices, the façade will be replaced, and, externally, the building will be as venerable as ever.

German Amateur's Triumph

THE novel Accuracy Contest, organised by the society of leading European amateur transmitters known as the Ragchewing Club, drew participants from regions as wide apart as Finland and the Sahara, and in a keenly fought contest the German station, D4UAN, captured first place.

The object of this contest, as announced in *The Wireless World* a few weeks ago, was to promote efficient operating by encouraging participants to relay messages from country to country in the language of the originating country, and not in the ubiquitous English generally employed among "hams."

D4UAN, admirably located "right in the centre of things" at Nuremberg, amassed the enormous total of 933 points, by handling no fewer than 206 messages. The runner-up, PA00Q, of Eindhoven, obtained 428 points with ninety messages. Among the British competitors, station G2ZQ, operated by Mr. J. Hunter, of Blackheath, secured first place among the ten "G" participants, all work being carried out on the 7,000 k.c. (42-metre) amateur band.

"Electrical Music" Postponed

THE European broadcast of "electrical music" arranged for February 16th and referred to in our last issue, was postponed at short notice. News of the revised date of this interesting concert will be eagerly awaited.

Licences for Norwegian Listeners

ON July 1st next the Norwegian State will take over control of all broadcasting stations from the private companies now owning them. Thenceforth all wireless sets must be licensed at a fee of 10 crowns (approximately 18 shillings) per annum.

Amateur Transmitter for Everest Attempt

THE British expedition which will shortly leave England to conquer Mount Everest, under the leadership of Mr. Hugh Ruttledge, is relying largely upon radio to enable the advanced exploring party to keep in touch with the base camp, where a powerful commercial-type transmitter will be erected. But at the advanced radio station at camp No. 3, at an altitude of approximately 21,000 feet, a special portable transmitter will be used which has been constructed by two members of the Radio Society of Great Britain, G6RL and G6US.

Wireless Parts for Unemployed

AN appeal for unwanted wireless components is issued by the Peel Institute, 65, St. John Street, London, E.C.1, in connection with work which has been organised for unemployed men in the district. All sets built at the Institute are used by the men themselves. Enquiries will be gladly answered by Mr. A. R. Kelly at the Institute.

Three-hour Funeral Broadcast

ACCORDING to a Berlin correspondent, a singularly depressing broadcast took place on Sunday, February 5th. All German stations except Königswusterhausen, Stuttgart, and Munich broadcast an electrical recording of the complete funeral service of a young Nazi who was shot on January 30th, and the item lasted three hours!

What's Wanted

THIS is the title of an interesting booklet issued by the Institute of Patentees, giving a list of 895 "needed inventions." The wireless section includes the following:—

Coils which have square-topped selectivity curves to a greater degree than those at present in use.

A really satisfactory interference eliminator.

Cheap device for automatically switching a set off when the station goes off.

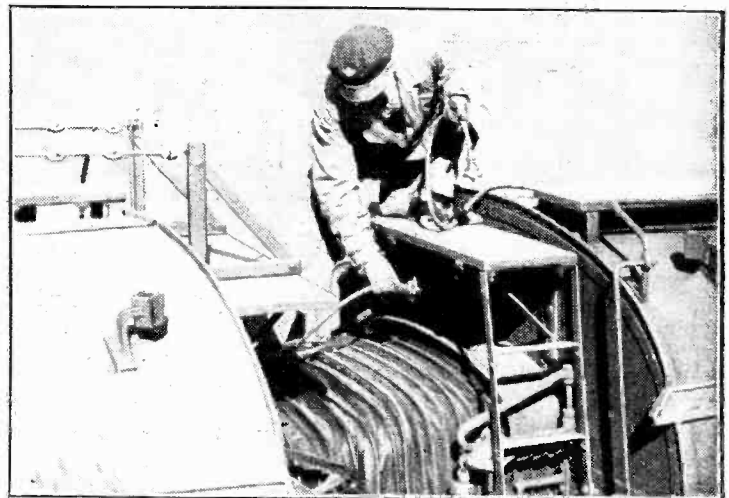

RADIO ROUTINE. One of the daily tasks of this shunter on the Hungarian State Railways is to join up the wireless reception cables when connecting the radio car to other coaches.

The portable transmitter is a redesigned ex-W.D. trench set rebuilt to form a self-excited continuous-wave transmitter, operating on wavelengths between 60 and 120 metres. Two P.M.4 valves, supplied by the courtesy of the Mullard Wireless Service Co., are used in the transmitter; the maximum input is 15 watts; H.T. is supplied by an ex-W.D. hand generator and L.T. is taken from Siemens inert cells.

The whole installation is extremely compact and light, and can be carried by one man.

H.F. inductance coils stamped out of sheet metal in a flat spiral.

An efficient loud speaker (the present efficiency is only one or two per cent.).

A Q.P.P. Set

IMPRESSIVE results were obtained on a moving-coil loud speaker actuated by 1½ watts output when the "Aerodyne-Hawk" battery-operated receiver of Messrs. Hustler, Simpson and Webb, Ltd., was demonstrated last week. This new set incorporates quiescent push-pull.

Automatic Volume Control—

to obtain two equal outputs to drive the push-pull stage the load is placed partly in the cathode and partly in the anode circuit, R₃ and R₄ being the two load resistances respectively, the values of which are adjusted in order to equalise the outputs from the points P and Q. C₁ and C₂ are blocking condensers which must be used to prevent D.C. voltages from reaching the grids of the push-pull output stage.

In order to obtain the delay action the A.V.C. voltage is not taken directly from the cathode circuit, but tapped off from the second diode A₂, through a suitable smoothing circuit R₆ C₆. This second diode is normally biased from the potentiometer R₇, the slider S of which

is set so as to give the minimum bias required by the controlled valves. With no signal the cathode is positive with respect to S by a voltage equal to the delay voltage, and until this delay voltage is exceeded the diode A₂ does not rectify and the grids of the controlled tubes remain at the same D.C. potential as S. As, however, the signal increases the cathode becomes more negative, and eventually assumes the same potential as A₂, which then takes circuit. Due to the low impedance of the diode compared to the resistance R₅, A₂ thereafter remains at approximately the same potential as the cathode, the A.V.C. then taking its normal effect just as it would if connected directly to the cathode.

Due to the lower amplification required with this type of automatic volume control, an inter-carrier noise-suppressing device is not so necessary, and it is usually sufficient to make the threshold sensitivity of the set slightly above the prevailing noise level.

It is hoped to follow this article with another describing a commercial development of the double-diode triode valve.

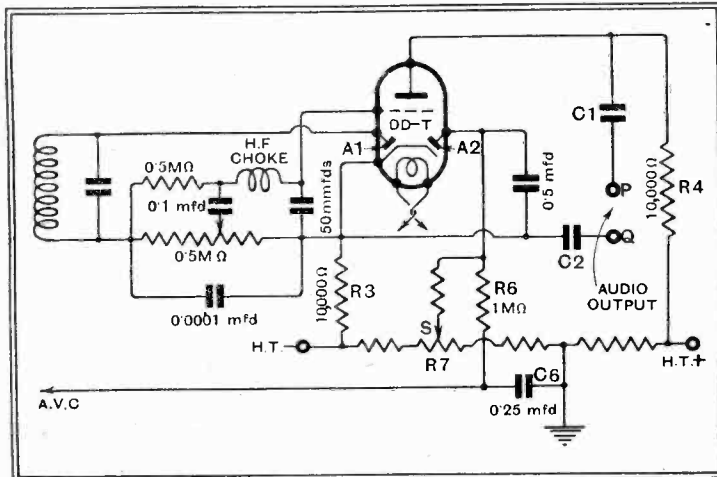
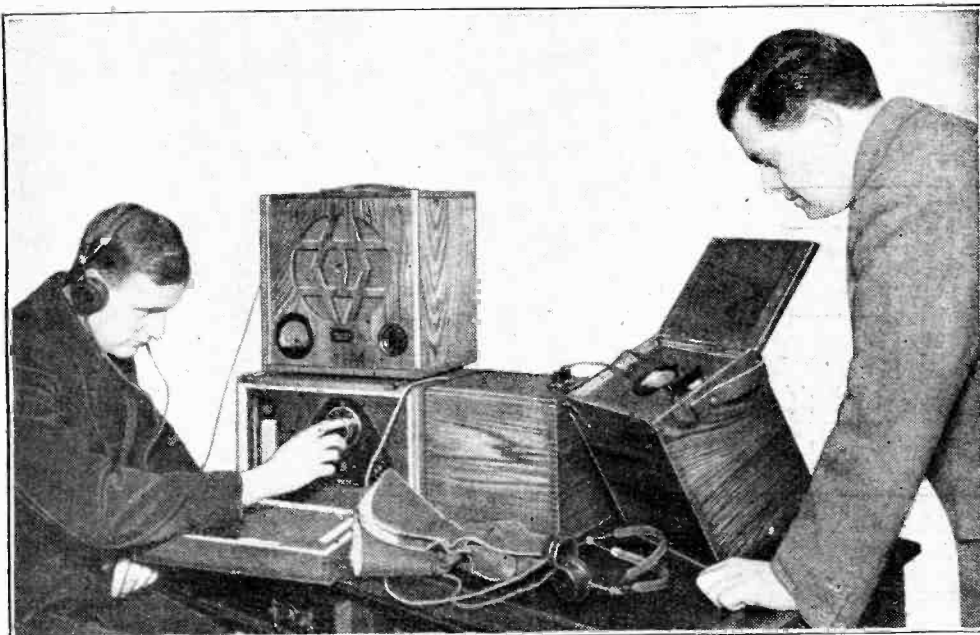

Fig. 7.—Delayed and amplified A.V.C. arranged for coupling into a push-pull output stage.

WIRELESS ON THE EVEREST EXPEDITION



Rapid communication with the base camps should be of the greatest assistance to the party which will shortly attempt to scale the world's highest mountain under the leadership of Mr. Hugh Ruttledge. The photograph shows (left) Mr. Smythe, the second in command, examining the McMichael short-wave receivers which will be used as far as base camp No. 3, half-way towards the summit. On the right is Mr. David Richards, another member of the expedition, who has been responsible for the wireless organisation.

"ULTRA-SHORTS" IN PORTSMOUTH

ULTRA-SHORT-WAVE tests with amateur-built apparatus are yielding some interesting results in the Portsmouth district, where Mr. Albert Parsons, lecturer at the Municipal College, has been transmitting over the city roofs on wavelengths of the order of 150 centimetres.

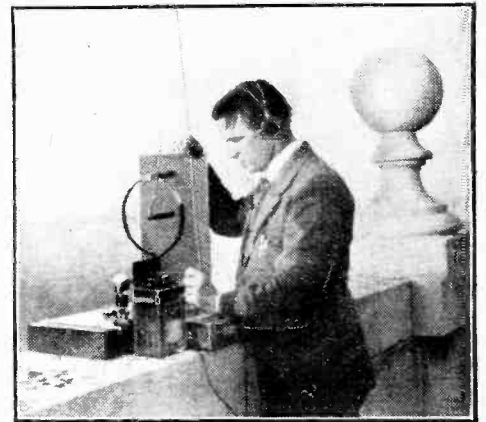

Mr. Albert Parsons with his ultra-short-wave transmitter on the roof of the Technical Institute, Portsmouth.

Excellent speech has been transmitted on 150-200 centimetres without noticeable deflection by intervening objects although some deviation has been observed when using an impromptu harmonic wave reflector system.

It is interesting to note that interference by electrical machinery was practically nil on the 200-centimetre wave despite the near proximity of a mercury arc rectifier used for the town supply.

We understand that Mr. Parsons will shortly attempt ultra-short-wave tests between Southsea and the Isle of Wight.

o o o o

BOOKS RECEIVED

Wireless: Its Principles and Practice, by R. W. Hutchinson, M.Sc. Written for wireless amateurs, experimenters and students, and comprising the theory of wireless telegraphy and telephony and its practical working, expressed in a simple, rational and scientific way. Pp. 271+xii., with frontispiece and 220 diagrams and illustrations. Published by the University Tutorial Press, Ltd., London. Price 3s. 6d.

Wie helfe ich mir Wenn mein Rundfunk-Empfänger Versagt, by Hans Coler and Karl Roessger. 2nd edition, revised. A short and instructive book on tracing and repairing faults in wireless receivers. Pp. 38, with 27 illustrations and diagrams. Published by Rothgier und Diesing A.G., Berlin. Price R.M.2.

Physics in Meteorology, by G. C. Simpson, C.B., C.B.E., D.Sc., LL.D., F.Inst.P., F.R.S., Director of the Meteorological Office, London. A reprint of a lecture given before the Institute of Physics in November, 1932, showing the application of sound, light, heat, magnetism and electricity, to the solution of problems of meteorology. Pp. 22, with 5 diagrams. Issued by the Institute of Physics, London.

Hints and Tips for Motor Cyclists (11th Edition), compiled by the staff of *The Motor Cycle* and containing 721 useful hints and instruction on all subjects connected with equipment, repair and upkeep of motor cycles. Pp. 204+xiv. Published by Iliffe & Sons Ltd., London. Price 2s.

Parallel-Feed Precautions

The Limitations of Decoupling

By M. G. SCROGGIE, B.Sc., A.M.I.E.E.

SOMETIMES in changing over from one system to another which is better—or more fashionable—the anticipated improvement fails to materialise. The resulting disappointment may slightly cloud our normal judgment and cause us to lay the blame on the new system. Nevertheless, the case against it is not necessarily proved, for there is a possibility that certain other effects have been brought into operation that were not there before and that are no essential part of the new arrangement.

The now popular parallel-feed transformer coupling is a case in point. In adopting it there is a risk of running into at least one danger that is not obvious. The fact that no undesirable effects due to this cause exist when a directly fed transformer is in use tends still further to conceal the trap from the unwary.

To avoid creating needless alarm it should be pointed out at this stage that users of battery-driven sets, or, at least, those with grid-bias batteries, need read no further. On the other hand, readers addicted to resistance or choke coupling should, for the purposes of this article, consider themselves, however reluctantly, to be included among the followers of the parallel-feed transformer coupling, for the matter applies, in lesser degree, to them.

It should also be mentioned that the parallel-feed system includes more than one circuit arrangement. The one dealt with here is that

which seeks to gain extra amplification by applying both primary and secondary voltages to the grid of the succeeding valve, or occasionally to give the effect of a lower-ratio transformer by connecting in similar fashion, but with one of the windings reversed. This is often described as the auto-transformer connection, and requires that the two windings of the transformer be connected together at one point.

It is shown in Fig. 1. The items enclosed within a dotted line can be purchased as one unit. R1 is the resistance for feeding the first valve with current and at the same time diverting "signals" through the trans-

former primary winding P by way of the condenser C1. The circuit to the cathode of the following valve is completed by C2, another fairly large capacity. A signal voltage is therefore set up between the cathode X and the point Y (which, as C1 is supposed to be large enough in capacity to offer negligible impedance, is practically the same thing as the anode of the previous valve). Owing to the action of the transformer, another voltage three or four times greater—according to the step-up ratio—is generated by the secondary winding between Y and Z (the grid of the second valve).

If the transformer windings have been connected up the right way the total voltage applied to the valve between X and Z is the original voltage plus the multiplied voltage. So far everything goes according to plan.

Now we turn attention to the little group of components in the corner—R2, R3, and C2. This is the usual recommended system for providing the second valve with grid bias. R2 carries the valve current, and its resistance is so chosen as to drop the correct number of volts for biasing purposes. The resistance generally lies between 300 and 1,500 ohms, the actual figure depending on the type of valve.

The current carried by R2 consists not only of the unvarying feed to the valve, but also of the signal currents created in the second valve by the action of the transformer coupling. Now, it is only the voltage dropped by the former that we wish to apply as negative bias to the grid—or, what is exactly the same thing, positive bias to the cathode. If the signal voltages also are fed back between cathode and grid they conflict with those arriving lawfully via the transformer, and

the result is a loss of amplification that may amount to more than 80 per cent. in power.

To overcome this difficulty the signal currents may be provided with an easy short-circuit path in lieu of R2 by shunting it with a condenser. The effectiveness of such a condenser depends on frequency; if it is 1 mfd., for example, at 5,000 cycles it is 30 ohms; at 500 cycles, 300 ohms; and at 50 cycles 3,000 ohms. So that while it provides an effective by-pass for the high notes, at 50 cycles it might almost as well not be there. While the high notes are up to full strength the low are brought down to perhaps one-fifth power, and the last state is worse than the first.

Shunting the Decoupling

But by interposing R3, of about 100,000 ohms, even the 3,000 ohms of C2 at 50 cycles is virtually a short-circuit, and the signal voltage across R2 is prevented from doing anything between X and Z, which are the points between which the input to the valve is reckoned.

If the foregoing explanation has been followed it will be understood that the condenser C2 has been rendered effective only by the contrast between its 3,000 ohms or less and the 100,000 ohms of R3. If R3 were reduced to 3,000 ohms the arrangement would be much less effective—only about half as good. For example, if a comparatively low resistance were to be connected in parallel with R3, the decoupling or filtering effect of the whole arrangement would depend

IS the extra amplification obtained by auto-coupling an L.F. transformer worth while? The author points out the difficulties which arise in decoupling this circuit and shows that in a mains set it is preferable to use the more conventional transformer coupling in which the primary and secondary are not directly connected.

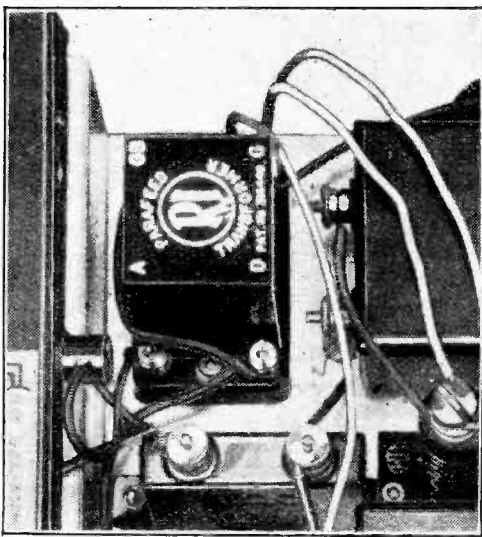

Typical example of a parallel-feed transformer with its associated components in a Wireless World receiver.

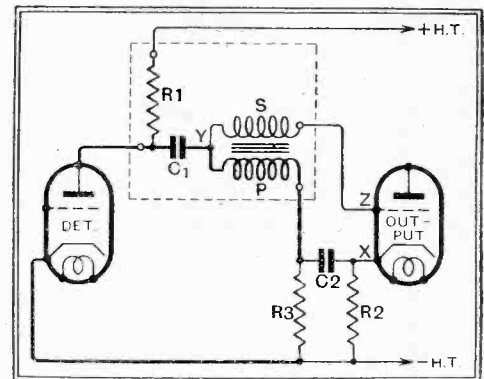

Fig. 1.—Parallel-feed and auto-coupled L.F. transformer. The decoupling resistance R3 is shunted by the circuit shown in heavy lines and so becomes partially ineffective.

Parallel-feed Precautions—

almost entirely on the low resistance, and no increase of R3 would avail to put things right.

Of course, nobody would dream of connecting such a low resistance intentionally. And yet one has been connected in the circuit diagram, just as surely as if it had been labelled R4. No award is offered for finding it, for it has been marked in heavy lines. It is true that it comprises several assorted items, to wit, one valve, one condenser, and one transformer primary winding. The resistance of an A.C. valve in the position shown is generally about 10,000 ohms. The condenser has quite a low impedance if it is doing its job properly. The only high impedance is P.

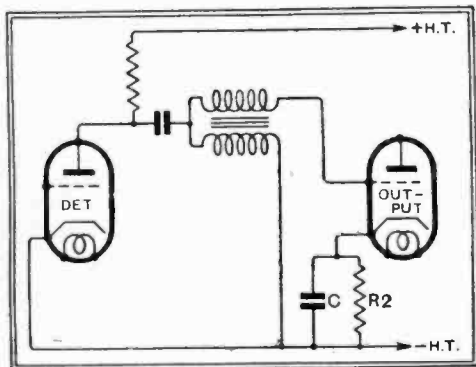

Fig. 2.—The automatic bias resistance R2 may be shunted by an electrolytic condenser of 50 to 100 mfd., thus preventing the disability of the circuit of Fig. 1.

This takes to itself practically the whole of the signal voltage across R2, in other words, just the voltage we are anxious to exclude from the valve input. But much worse than that; the transformer steps it up and applies the multiplied signal, plus the original, between X and Z.

This makes the position very serious indeed. It is bad enough to have the voltage drop across the bias resistor fed back, but if it is multiplied by four or five en route more than four-fifths of the amplification may disappear, while if the secondary is reversed it is usually capable of setting up continuous "motor boating," which none of the usual decoupling devices avails to cure.

Battery bias is not a remedy to appeal strongly to the owner of an "all-electric" set. One alternative is a very large condenser C across to R2 (Fig. 2). Nothing less than 50 or 100 mfd. is advised, and, fortunately, such a large capacity is obtainable at reasonable cost, since the development of electrolytic condensers. Another cure is to connect the cathode of the first valve so that the

offending voltage is not included (Fig. 3). An ordinary condenser of 1 mfd. or thereabouts is then suitable for C2, and

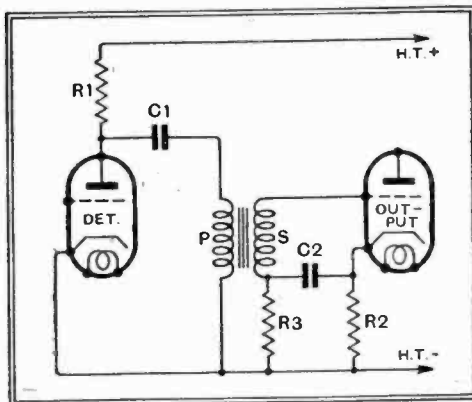

Fig. 4.—Although the extra amplification of auto-coupling is lost by this method of connection, decoupling becomes straightforward.

R3 is the usual 100,000 ohms. It is very important to see that the grid of the first valve is preserved from defilement by the objectionable feed-back. Generally it is a detector, with a grid leak taken straight to its cathode. Then all is well.

Alternative Circuits

A disadvantage of the Fig. 3 system is that the current to both valves passes through the same biasing resistor R2, which consequently must be lower in resistance.

Still another remedy is to connect the transformer as in Fig. 4. This is the method adopted in certain parallel-feed units. The two valves are then inductively coupled, and the primary winding is returned to a point where it does not complete the feed-back path. The

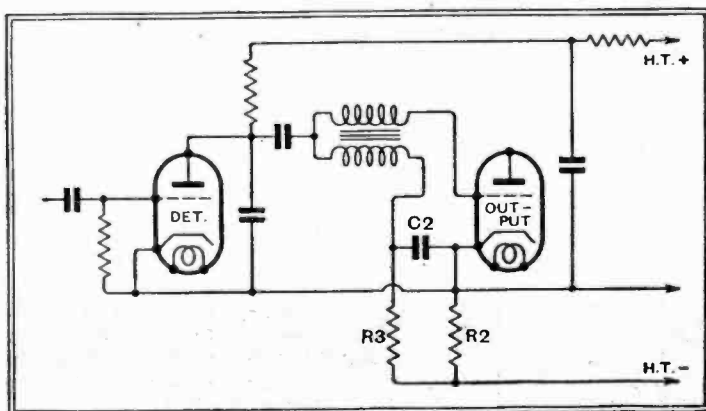

Fig. 3.—Another cure is to connect the cathode of the first valve as shown above.

extra amplification that is possible with a parallel-fed auto-transformer is thereby sacrificed, but it is better to do this voluntarily than to have a much larger slice of amplification forcibly taken away.

Unless these matters are in order the parallel-feed coupling certainly cannot give of its best. The bias system of Fig. 1 breaks down also for resistance or choke coupling, but the effects are not so dire, because of the absence of step-up. Nevertheless, there is no point in using methods that don't work properly, and may give rise to distinctly poor quality of reproduction.

CLUB NEWS

Automatic Telephones

SLADE Radio deserted wireless topics at a recent meeting, when Mr. R. G. St. George lectured on "Automatic Telephones." With the aid of lantern slides members were given a very clear understanding of the principles of the dialing, ringing and receiver circuits. A diagram of a 25-line private exchange was of the utmost interest.

The Society still has vacancies for new members, and enquiries will be welcomed by the Hon. Secretary at 110, Hillaries Road, Gravelly Hill, Birmingham.

Practical Direction Finding

PRACTICAL hints on direction finding and field days were given by Mr. Alexander Black at a recent meeting of the North Middlesex Radio Society, members of which have long been fascinated by this particular branch of radio. Mr. Black brought with him a D.F. set constructed on new lines. He considered that, in the absence of exceptional precautions, screening of the frame was a waste of time, and reminded his hearers of the success of Mr. Maurice Child's scheme last summer when using an open aerial and adjustable coupling coil for neutralising the vertical component of the signal—the cause of the majority of errors.

Hon. Secretary: Mr. E. H. Laister, Windflowers, Church Hill, London, N. 21.

Electric Clocks

ELECTRIC clocks provided an interesting theme of discussion at the meeting of the Croydon Wireless and Physical Society on January 23rd, when Mr. A. J. Webb, M.A., B.Sc., A.M.I.Mech.E., gave an outline of the various applications of electricity to horology. Several modern electric clocks were demonstrated, including the modern Buller self-driven clock, the synchronous motor clock driven from the 50 cycle A.C. mains supply, and a Hope-Jones synchronous master pendulum made by the lecturer.

Hon. Secretary: Mr. H. T. P. Gee, 51-52, Chancery Lane, London, W.C. 2.

For Short-wave Enthusiasts

A NEW Short-wave Listening League is willing to collaborate with any organisation in the exchange of reception reports and general research on the high frequencies. The members send notification of transmissions heard to headquarters each month.

All communications should be addressed to Mr. B. Dye, 213, Green Lane, Rawmarsh, Rotherham, Yorks.

Ratepayers' Radio

SOME interesting tests on the detection of distortion were carried out by Mr. Valentine, of Messrs. The Mullard Wireless Co., Ltd., at the last meeting of the Radio Section of the New Eltham Ratepayers' Association. Two amplifiers were used, connected to a single pick-up and speaker; by means of switches each amplifier was brought into use in turn. Listeners could detect at once the effect of changing valves and grid bias and could observe the baneful effects of overloading.

Hon. Secretary: Mr. A. E. Gillborn, 87, Montbelle Road, New Eltham, London, S.E. 9.

Photo Cells Explained

"PHOTO-ELECTRIC Cells and Gas-filled Relays" was the title of a lecture given by Mr. Inchley, of the General Electric Co., Ltd., at a recent meeting of the Smethwick Wireless Society. The lecturer dealt with the difficulties of manufacturing caesium cells and by working models demonstrated their practical applications. Describing the construction and action of the gas-filled relay, the lecturer demonstrated the various effects produced by the combination of photo-electric cell and relay using D.C. and A.C. He showed that the filament emission of the relay was sufficient to light a 15-watt lamp.

Hon. Secretary: Mr. E. Fisher, M.A., 33, Freeth Street, Oldbury, near Birmingham.

BROADCAST

By Our Special Correspondent

The Placid B.B.C.

PARLIAMENT can scarcely be flattered by the sublime nonchalance with which everyone at Broadcasting House is contemplating the House of Commons debate on broadcasting on Wednesday next, February 22nd. Even the existence of two special Parliamentary Committees—one of them self-appointed—to enquire into the activities of the Corporation fails to ruffle the beatific calm on the faces of those in authority at Portland Place.

Let 'Em All Come

It is being whispered, indeed, that Sir John Reith would welcome many more Parliamentary Committees with the same objects in view, for, although "in a multitude of counsellors there is wisdom," it is no less true that "too many cooks spoil the broth." If, as could easily happen, the Committees begin quarrelling among themselves. . . .

A Great Night at Westminster

Whatever happens, the debate on February 22nd is certain to be entertaining, and I wish the B.B.C. could arrange to broadcast it. If the truth were known, nearly everybody on both sides of the House is a broadcast listener and, as such, is anxious to assert his or her own viewpoint.

What a night!

Pleasant Sunday Evenings

MANY listeners to the foreign programmes will be relieved to know that the B.B.C. definitely state that no attempt is to be made to fill the 6 to 8 p.m. interval on Sundays with programme material of any description. This categorical denial of a rumour is reassuring, and makes one wonder why such rumours are not strangled at birth.

An Australian Enquirer

AFTER several months' stay in this country, during which he has conducted a thorough investigation of B.B.C. methods, Dr. R. S. Wallace, Vice-Chancellor of Sydney University and a member of the Australian Broadcasting Commission, left last week for a month in America, after which he will return to Australia via London.

Something to Learn

When I saw him, Dr. Wallace was full of enthusiasm over his reception at Broadcasting House, where every facility and enough literature to stock a library were placed at his disposal.

"I go away," he said, "with a good working knowledge of B.B.C. methods. We in Australia have a lot to learn from the B.B.C., but I hope that my Commission may be able to show the B.B.C. some day that it has something to learn from us."

Empire Emissaries

Dr. Wallace's latter remark was probably based on the suggestion that sooner or later the B.B.C. will send emissaries to Australia and other parts of the Empire to enable them to get not only broadcasting ideas, but first-hand information on what Empire

listeners want from the B.B.C. in the way of programme material.

Such visits, however, are not likely to take place until the Empire transmissions are put on a more stable footing.

Contributions from the Empire?

It is now openly stated at Broadcasting House that a permanent Empire service may involve a contribution from different parts of the Empire.

Entertainment Department

AN Entertainment Department to take charge of vaudeville and similar broadcasts is to be established with Mr. Eric Maschwitz, now Editor of *The Radio Times*, as Director.

Mr. Maschwitz is expected to take over his new duties in May next.

The New Director

Anyone who has spent even a minute or two in the company of Mr. Maschwitz, or "Holt Marvell," will recognise that he is an Entertainment Department by himself. What will happen when he imbues a staff with his own irrepressible spirits I tremble to think.

Aspirants for Editorial Chair

Several B.B.C. aspirants for the editorship which Mr. Maschwitz is resigning have already made their applications, but I fear that the chances are not entirely in favour of a staff man. Certain people with journalistic attainments outside Broadcasting House are also being considered.

Mr. Sieveking

Mr. Lance Sieveking, who has been handling some of the vaudeville programmes, will probably find a berth in the Talks Branch.

An Unhappy Thriller

Edgar Allan Poe's thriller, "The Fall of the House of Usher," the broadcasting of which was postponed some months ago owing to the illness of the B.B.C. producer, Peter Creswell, has been restored to the National programme for March 9th, and will be given Regionally on March 10th. The microphone version is by Peter Creswell and Barbara Burnham. Mr. Creswell will be responsible for the production.

Dr. Bredow's Resignation

THE resignation of Dr. Hans Bredow from the post of German Radio Commissioner means the departure of one of the big figures in European broadcasting. It was Dr. Bredow who presented Sir John Reith with the stained-glass window, showing St. Cecilia, which now adorns the "D. G.'s" room at Broadcasting House.

The retiring Commissioner was responsible for the first German broadcasting organisation ten years ago.

Sir John Reith's Unique Post

At no time, however, could it be said that Dr. Bredow wielded so much power as Sir John Reith, who seems to stand alone as a broadcasting "dictator," answerable only to a Board of visiting Governors.

M. Van Sonst, who is Sir John's "opposite number" in Belgium, can perhaps claim similar authority. Messrs. Aylesworth and Paley, who are Presidents of the National and Columbia broadcasting systems respectively, are much in the same category as Managing Directors of limited liability companies.

A Hard-working Chief

In Italy the Managing Director of the Broadcasting Company—Signor Chiodelly—is also the Chief Engineer, so I imagine he has his hands full.

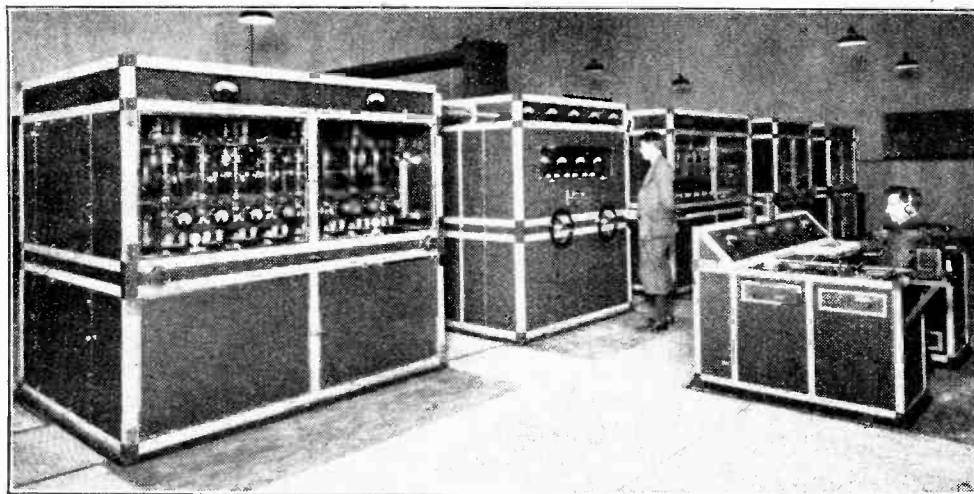

ANOTHER BIG VOICE. The transmitting hall of the new Marconi 60 kW. broadcasting station at Athlone, Irish Free State. The transmissions, which are heard at considerable strength throughout Great Britain, were inaugurated by Mr. De Valera on February 6th.



Majestic Superheterodyne

EARLSWOOD MODEL. TYPE 261B

A Seven-valve Receiver with
Automatic Volume Control

A CONSIDERABLE amount of work has been done recently on both sides of the Atlantic in solving the special problems arising from the exceptional range and selectivity of superheterodyne receivers, and the Majestic range of receivers is illustrative of the advance that has been made in the matter of ease of control and reduction of heterodyne whistles.

The aerial circuit is somewhat unusual, and is designed to give uniform coupling over the long- and short-wave bands, and also to eliminate second-channel interference. The first object is achieved by a combination of inductive and capacity coupling (L₁ and C₁), and the second by feeding back a part of the amplified signal from the cathode return lead of the first H.F. valve through the coupling coil L₂. The circuit constants are adjusted so that the feed-back tends to neutralise all incoming signals other than those to which the set is tuned.

Constancy of amplification over the tuning range is maintained in the coupling between the H.F. amplifier and the first detector by a combination of magnetic and capacitive coupling which takes the form of a few "dead-end" turns on the high-potential end of the transformer primary. These two stages, and also the I.F. amplifier, make use of the latest variable-mu screen-grid pentode valves, which are capable of a wide range of power-handling capacity without distortion.

The detector valve comprises a full-wave diode rectifier and a three-electrode amplifier in the same glass envelope. An adequate grid swing for the pentode output valve is thereby assured, with resistance-capacity coupling between the two stages.

Chassis Design

From the production and servicing point of view the chassis is a model design. The base is a one-piece pressing of exceptional rigidity, and can be lifted out of the cabinet after withdrawing the loud-speaker plug and detaching the control knobs without any fear of straining the wiring through warping of the chassis under the weight of the components. Special attention has been given to the question of con-

stancy of performance under severe changes of climatic conditions. All coils, by-pass condensers, etc., are impregnated in special wax, and tests have shown that the set functions satisfactorily at a temperature of 115 deg. F. in an atmosphere of 90 per cent. humidity.

The handling of the controls should present not the least difficulty to a non-technical listener, provided that the importance of accurate tuning is realised at the outset. The quality of reproduction is the best indication of whether the set is exactly in tune with the station required, for the effect of the automatic volume control circuit is to cause a marked rise in pitch if the station is off tune by so much as the thickness of the shadow line on the indirectly illuminated scale. Actually the thickness of the shadow is about 10 k.c. on the scale, and as the latter is calibrated in kilocycles it represents approximately the band occupied by adjacent stations.

Of the range and sensitivity of the set there can be no question. During the course of an hour, on a 50ft. aerial five miles from Brookmans Park, no fewer than sixty-six stations were identified on the medium-wave range. In logging these stations none was recorded which suffered from serious heterodyne interference, and more than forty required generous use of the manual volume control to bring them down to a reasonable level for a living room. Heterodyning between stations is, of course, beyond the powers of the receiver to suppress, but heterodyne whistles generated within the set were found to be much fewer than in many superheterodyne receivers we have tested. For this happy result the ingenuity shown in the design of the aerial circuit is largely responsible.

Reception at a distance of five miles from Brookmans Park is a severe test of selectivity, even for a superheterodyne. With the Majestic, however, only one channel was lost on each side of the National and Regional transmitters. At a slightly greater distance from the high-powered stations 10 kc. selectivity could be

confidently predicted at all parts of the tuning dial. Incidentally, the uniform sensitivity over both wave-ranges deserves special comment.

The action of the automatic volume control is flawless. But for slight differences in the level of background noise it would be difficult to estimate the relative powers of distant stations or to detect the presence of fading; and this clue is

only available on very weak stations, for with the average Continental transmission the signal strength is sufficient to reduce background noise to the vanishing point. According to the makers, a 100:1 change in signal strength produces a change in volume of only 2:1. As a matter of interest, the effect was tried of tuning-in a station on a 3ft. length of wire attached to

the aerial socket and then adding a 75ft. outdoor aerial. The change in volume was just noticeable, and was estimated at about 5 decibels.

Quality of Reproduction

There is an ample reserve of volume, and the predominating quality of reproduction is a full and round tone without any undue tendency towards an objectionable bass resonance. With the tone control in the "high" position there is just the required response in the treble to give good balance, and it should be necessary to make use of this control only in the few circumstances where low-pitched heterodyne whistles or background noises may make their presence felt.

Mains hum is rather high on first switching on the set, but soon subsides to an unobtrusive level when the valve heaters reach their normal temperature.

The proportions of the cabinet are dignified, and the polished walnut finish is in keeping with the general design.

The chassis illustrated is also available as the "Knightswood" table model in a cheaper cabinet at 24 guineas, while the 260-B chassis, with twin moving-coil loud speakers, is incorporated in the "Princewood" console receiver and the "Kingswood" radio-gramophone.

General.—Table model seven-valve superheterodyne. Moving-coil loud speaker. Automatic volume control. New variable-mu screen grid pentode valves and diode-triode detector.

Circuit.—H.F. amplifier—1st det.—Oscillator—I.F. amplifier—2nd det.—Pentode—Power rectifier. Provision for pick-up and external loud speaker. Universal mains transformer 105 to 250 volts, 25 to 133 cycles.

Controls.—(1) Main tuning, calibrated in kilocycles. (2) Manual volume control (radio and gramo.), and on-off switch. (3) Wave-range and gramo. switch. (4) Tone control

Price.—26 guineas.

Makers.—The Majestic Electric Co., Ltd., Tariff Road, Tottenham, London, N.17.

Screen-grid Pentode and Diode-triode Valves

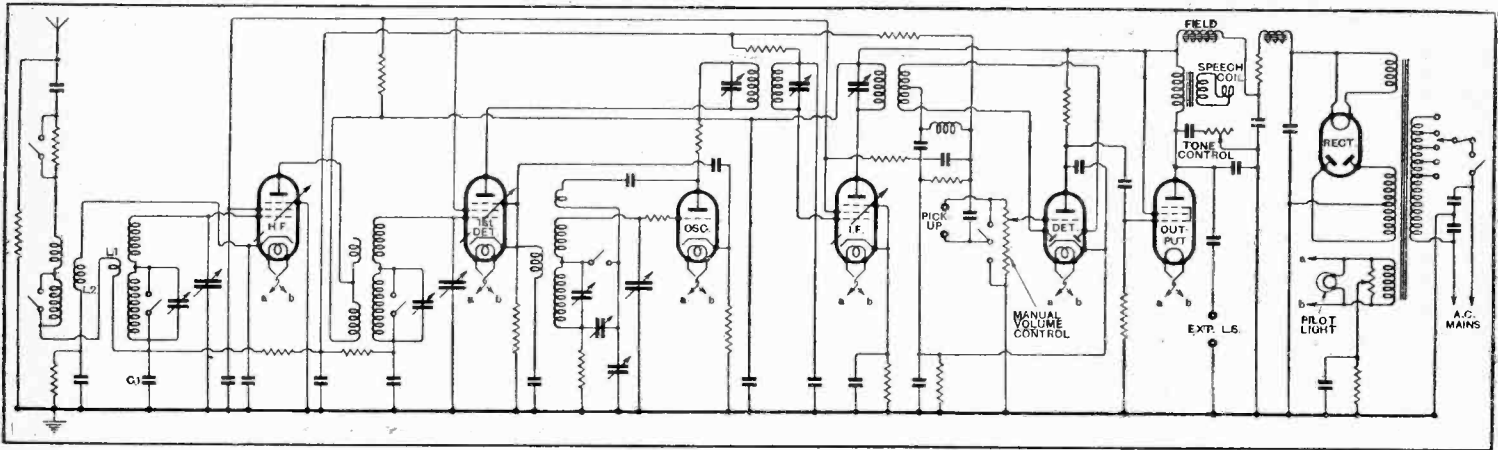

The circuit diagram. The second detector stage couples the duties of a full-wave diode rectifier and a three-electrode amplifier in its function as an automatic control valve.

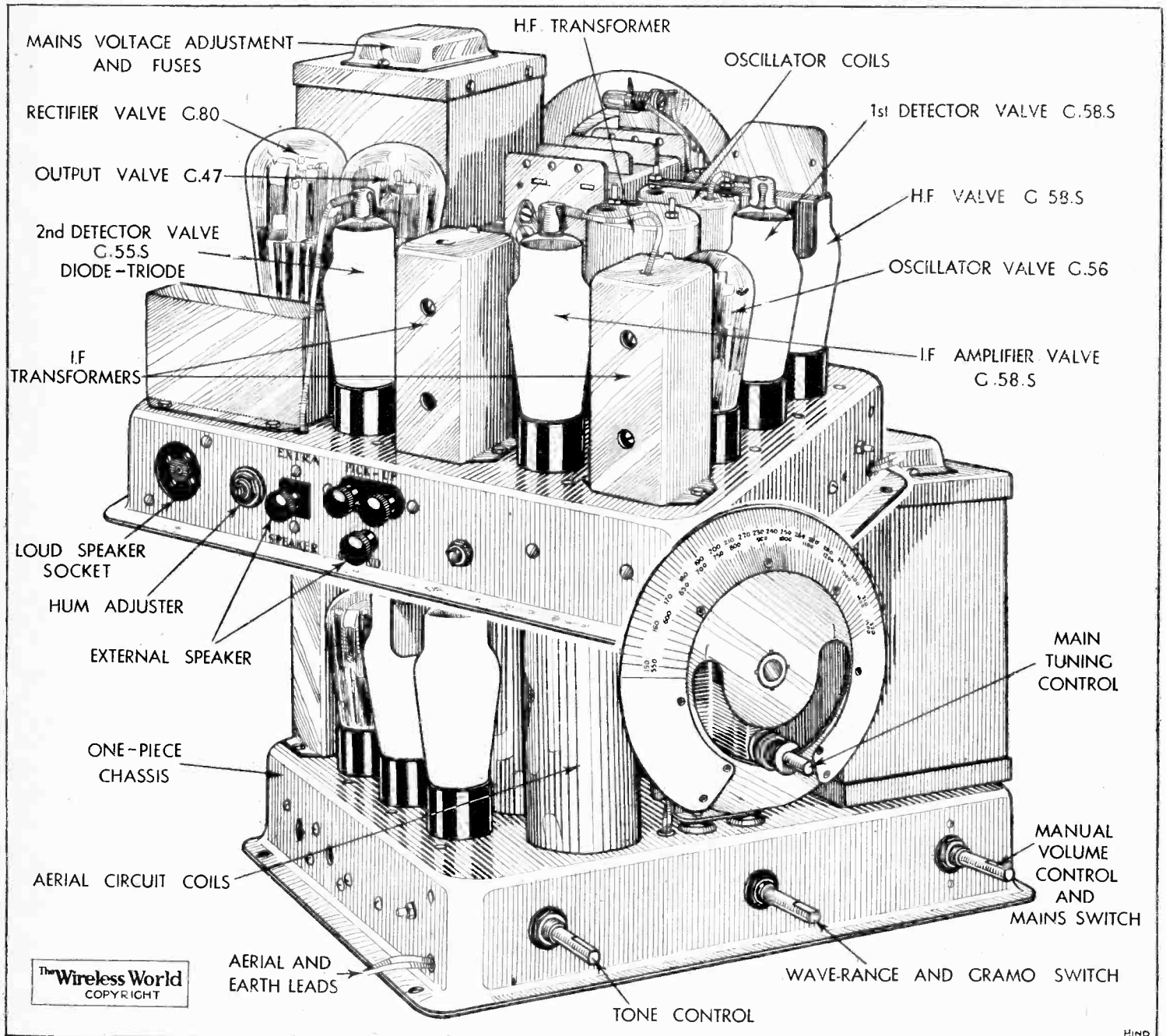

Mechanical rigidity and accessibility for adjustment and servicing have received special attention in designing the layout of the Majestic 260-A chassis.

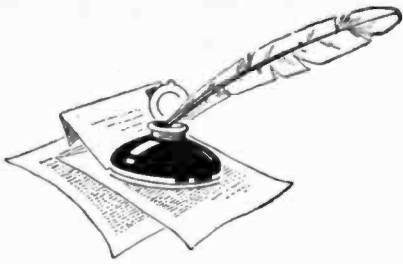

Correspondence

The Editor does not hold himself responsible for the opinions of his correspondents

Correspondence should be addressed to the Editor, "The Wireless World," Dorset House, Tudor Street, E.C.4, and must be accompanied by the writer's name and address

What Does the Public Want?

THOSE of your readers who support "Diagnostic's" views appear to be themselves the principal victims of the "huge misunderstanding" to which "Diagnostic" refers.

If these readers have no interest outside their local receivers, then they have surely wasted their time and money on wireless sets, and deserve to be condemned to listen only through the medium of a relay service with no further choice of programmes for the future. Surely, too, it is a "huge misunderstanding" for these readers to be interested in any wireless paper, and one wonders how they came to see the letter by "Diagnostic" in *The Wireless World*.

The discussion resulting from "Diagnostic's" letter seems to me to resolve itself into the simple conclusion that, if "Diagnostic" is right, then the sooner broadcasting through the ether is abandoned as a huge mistake the better, and programmes communicated, instead, through the medium of the wired relay.

In conclusion, I would like to remind "Diagnostic" and his supporters that in the early days of broadcasting in this country, reception, even of the local home station, was generally vastly inferior to what is now obtainable from the majority of the Continental stations. Progress in transmitter efficiency and improvements in receivers, including automatic volume control, would seem to promise us a wonderful choice of programmes in the near future. If British manufacturers prefer to pay attention to "Diagnostic," there is no doubt that, between relay services and American receivers, the British public will still get what it wants. **PROGNOSTIC.**

London, W.9.

YOUR correspondent, "Diagnostic," has the B.B.C. complex. He assumes the right to judge for the majority, and accepts the view of a small minority as the basis of his judgment.

I have been the proud (sic) owner of a wireless receiver for just one month. It is sold by the maker as "a set for the man who wants essentially home stations." Fortunately, the maker is honest to modesty. The set brings in some eighty foreign stations. It is well it does, for had I to rely upon home-station programmes for the last month that set would now be permanently inoperative.

The question of quality of programme is for the individual and not for "Diagnostic."

Some people may see humour in the performance of the Yorkshire mummers.

Some people may like their politics doled out by the Government-controlled B.B.C. in the Professor Laski fashion.

Some may care for the personal expressions of opinion given out under the heading of news, and some may even consider the nerve-wracking, horrible specimens of dance music on drum and saxophone to be satisfactory.

But to me, even with such short experience of listening in, it's a blessing to be able to tick off my own programme in *The Wireless World*, and listen to what I want—or at least to be able to shut out what I don't want—without having to shut down.

As to quality of reproduction, well, it may be better from North Regional or Daventry than from, say, Rome or Budapest. One would expect it to be.

But good-quality reproduction is merely an aggravation of bad music, and the majority of the relays from hotels and cinemas of jazz fall well within that category.

In my opinion, that is—and that's all that counts to me—or to anyone else.

Leeds.

TENTATIVE.

THE letter of "Diagnostic" in your issue of January 27th seems to me to come as near to the truth as it is possible when a case is stated with the necessary vehemence to produce sparks from the contact of controversial hammer and anvil.

This letter is of peculiar interest to me, because just about a year ago I made my own similar views on distant reception the subject of an article in *The Observer*. The result was a correspondence in which there were two dissents and one agreement with my views.

I am assured by observers on the Continent that the position there is much as it is here. There is a kind of sub-opinion that local programmes are inferior to those from a distance; but most listening time is actually occupied by the local stations. With regard to British listeners any real knowledge of the amount of time devoted to distant listening is almost impossible to obtain, at any rate without an enormous referendum.

As one who is closely in touch with public opinion, I would say that your correspondent is wide of the mark in some particulars. There is, as he admits, a considerable interest in the foreign stations of the knob-twiddling kind; but there is also a considerable public which does take an intelligent interest in foreign programmes.

When your correspondent suggests that those with true musical appreciation cannot long be satisfied with reception from distant stations I absolutely agree with him, and my opinion is based on experience of a substantial kind with all sorts of receivers, commercial and otherwise, and ranging in initial cost from £10 to £100. The fact is that the public capable of appreciating real quality is a very small one. Service engineers of the big companies tell me that in the majority of cases where a tone control is supplied, it is set to give as thick and as treacly a quality as is possible. There is, however, a very large public which is what may be called semi-educated musically, and though the reproduction they hear disgusts the musician they get very real enjoyment, and because they are not musically educated the "something

less" they get from distant stations is not distressing to them. Also, there is a very large public which is only satisfied with the most trivial, and that this public is powerful is evidenced by the Continental sponsored programmes which have a very large following in this country, particularly on Sundays.

To sum up; the B.B.C. programmes, particularly those which do not make use of long land-lines, are technically as good as any in the world; musically and educationally they are of a very high order. Reproduction approaching very nearly the original can be had from a local station only. This nearly natural reproduction presupposes very careful design in the reproducing instrument. The majority of commercial receivers give very good results; but in hardly any case do they give the best possible.

Apart from the large army of knob-twiddlers, there is a very real interest in foreign programmes which may be due to any one of a number of points of view. It is now too late to attempt the real musical education of the listening public. The B.B.C. has stultified its original educational endeavours by its insistence on the amusement to be had from distant listening, and our only hope lies in the gradual elimination of the electrical difficulties in distant listening which your correspondent so ably sets forth, and which *The Wireless World* has always acknowledged and done much to remove. **ERNEST H. ROBINSON.**

Woking.

AFTER ten years' listening to home and foreign stations, long, medium and short-wave, I most heartily agree with your correspondent that listening to home stations is the only real entertainment of an amusing and instructional character worth keeping the set on for.

Being in the trade also, I agree that sets must be capable of receiving the "foreigners" in order to appeal to those people who get a little thrill out of listening to some language that they cannot in the least understand, and also to be a bit above the people next door, who can only get twenty stations, and who do not wish to compete in the style of the anglers who can "tell a few."

From your local stations you expect to get, and do get, programmes of good quality and at steady strength, and, moreover, 100 per cent. understandable. That is good wireless entertainment.

From the foreign stations, if they are not giving the usual long-winded jabber, you get a very poor alternative to the home stations when it comes to musical entertainment. This, of course, is speaking generally, and I agree that occasionally you find a foreign station worth listening to, but for a comparatively short time only.

That is why I prefer now to stick to the locals—in other words: "Support Home Stations, and keep out the Foreigners."

Shrewsbury.

V. E. MORRIS.

LABORATORY TESTS

New Radio Products Reviewed

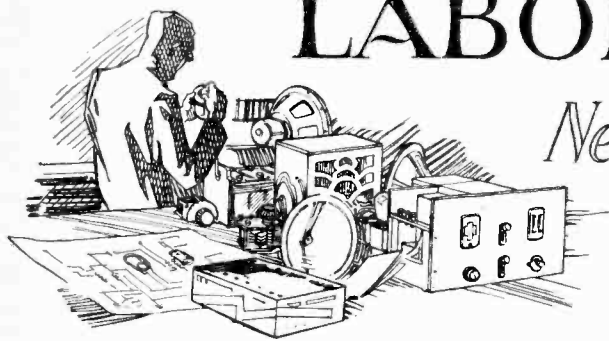

GOLTONE SCREENED COILS

THE new screened dual-range coils made by Ward and Goldstone, Ltd., Frederick Road, Pendleton, Manchester, are wound on 1½ in. formers and enclosed in aluminium cases measuring 3½ in. in length and 2¼ in. in diameter. In all there are five different types, and the windings have been chosen to suit the particular functions each coil is most suited to perform. No matter what the requirements may be there is a Goltone coil having well-proportioned windings and a suitable number of tappings for the purpose. Wave-change switches are not included, and these must be regarded as a separate item.

On test Goltone coils were found to compare very favourably with other coils of equivalent size and style; they are very efficient, and on the whole well above the average in performance.

The medium-wave winding has a measured inductance of 170 μH., so that when tuned with a 0.0005 mfd. condenser the waveband covered will be approximately 200 to 590 metres. The inductance of the long-wave section is 2,080 μH., which will give an effective wave-range of from 760 metres to just under 2,000 metres.

The price of these coils, including a small base screening plate, is 5s. 9d. each.

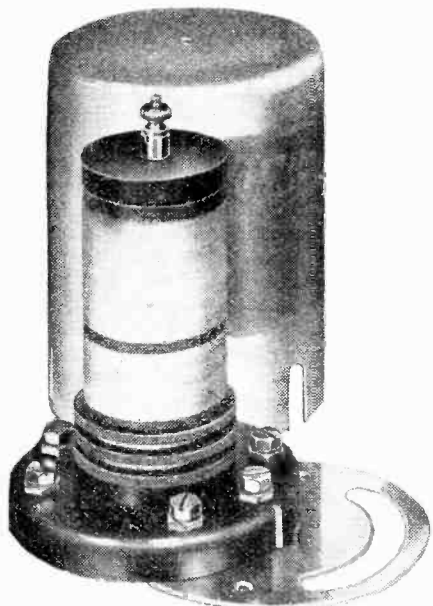

Goltone screened dual-range coil.

LOUD SPEAKER GRILLE FABRIC

A NEW style of fabric developed especially for covering the loud speaker fret has been placed on the market by the Pioneer Manufacturing Co., Cromwell House, Fulwood Place (High Holborn), London, W.C.1. Known as the Pioneer New Process Speaker Fabric, this material is so woven

that it imposes the minimum impedance to the passage of sound waves, as the weave is of an exceedingly open nature. The standard colour is a light gold, but a darker shade is available if preferred. Despite the "openness" of the weave the fabric effectively obscures the loud speaker and the inside of the cabinet.

It is sold in cartons with the material rolled to prevent creasing, and a piece twelve inches square costs 1s. A 15 in. x 15 in. size is priced at 2s., and each carton contains a small tube of glue.

M.K. FUSE PLUG

THIS fuse plug has been designed to afford adequate protection to a mains-operated receiver, and is fitted to the end of the lead in place of the standard two-pin mains connector. The plug pins are the British Standard 5-amp. gauge, and therefore fit the normal type of wall socket installed for light electrical apparatus.

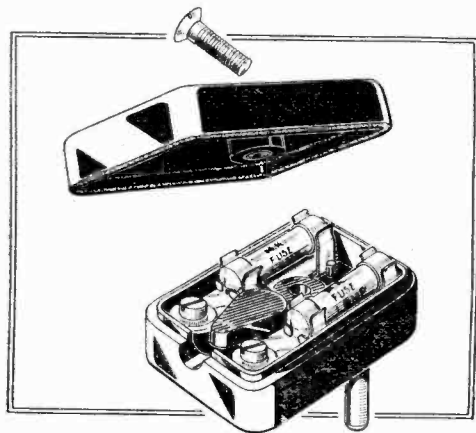

M.K. fuse plug fitted with two one-amp. fuses.

To avoid confusion with the ordinary mains plug the M.K. models are distinctive in shape, being rectangular in form and having the pins offset from the centre. Each model contains two small cartridge-type fuses—one in each supply lead—rated to "blow" at one amp. Fuses to give protection on two-amp. and five-amp. circuits are available also.

The makers are M.K. Electric, Ltd., Wakefield Street, Edmonton, London, N.18, and the price is 2s. in each case.

CORDO SCREENED H.F. CHOKES

SCREENED H.F. chokes particularly well suited for chassis mounting are now obtainable from Cordo Electrical Products, Ltd., 68, Victoria Street, Westminster, London, S.W.1. Two models are available known respectively as the Cordo Major and the Cordo Minor, the first mentioned having an inductance of 250,000 microhenrys. The inductance of the Minor is 150,000 microhenrys.

Samples of each type have been tested and found to be entirely satisfactory; their measured inductances are in close agreement with the makers' values, and, furthermore,

the self-capacity is reasonably low in each case.

The two connections, which take the form of soldering tags, are located at opposite ends of the cylindrical container, so that one is well placed for above-deck wiring, while the other, passing through a clearance hole in the chassis, can be included in the under-deck wiring by a very short lead.

The Minor model costs 2s. 6d., and the price of the Major is 5s.



Cordo Major and Minor screened H.F. chokes.

MAINS H.F. CHOKES

A PAIR of H.F. chokes for inclusion in the mains leads of D.C. sets has been submitted for test by Messrs. Sound Sales, Ltd., of Tremlett Grove Works, Junction Road, Highgate, London, N.19. The chokes are wound to the specification given for the components employed in *The Wireless World* Monodial D.C. Super, and they function in an entirely satisfactory manner.

Each choke consists of a single-layer winding of cotton-covered wire on a cylindrical former, and the winding is impregnated to render it impervious to moisture. A good point is the inclusion of ventilation holes in the base of the former, so that there is free

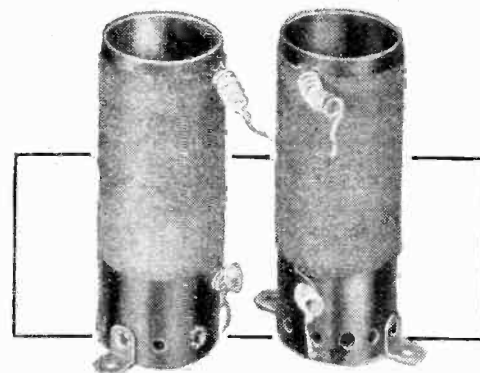

Sound Sales H.F. chokes for D.C. sets.

circulation of air. Mounting brackets are fitted, and the price is 3s. 6d. a pair.

Catalogue Received.

Manufacturers Accessories Co. (1928), Ltd., 85, Great Eastern Street, London, E.C.2.—Ninety-six-page catalogue illustrating and describing the proprietary range of receivers, accessories and components handled by this well-known wholesale house.

READERS' PROBLEMS

Reducing Transferred Capacity

BEFORE single-knob tuning became general, stray capacity in parallel with the tuned circuits of a receiver seldom gave us cause for anxiety. But nowadays this subject has assumed some importance, and it is not always easy to cover the full medium-waveband with a gauged tuning condenser having the usual 0.0005mfd. sections.

A case in point is brought up by a reader, who submits for our examination a circuit diagram of a straightforward H.F.-det.-L.F. three-valve set. His complaint is that the trimming condenser across the tuned H.F. coupling circuit has to be set at minimum capacity, while both the other corresponding trimmers are practically "all in." It is realised that this state of affairs is brought about by excessive strays in the coupling circuit, and our advice is sought as to how they may be reduced in value.

The part of the circuit in question is reproduced in simplified form in Fig 1 (a). Tuned grid coupling is employed, the plate of the H.F. valve being connected through a feed condenser C₃ directly to the high-potential end of the coupling inductance L.

Now the stray capacities across this circuit are bound to be fairly high; they will

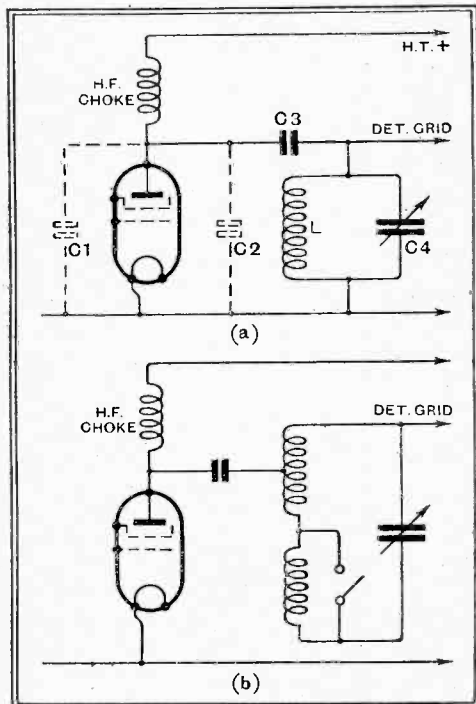

Fig. 1.—In diagram (a), stray capacities represented by C₁ and C₂ are transferred practically *in toto* to the tuned-grid coupling circuit. The proportion of transferred capacity is greatly reduced by adopting a tapped-down anode connection (diagram (b)).

include, for instance, the self-capacity of the H.F. choke, represented by C₁, and also the anode-cathode capacity of the screened grid valve (C₂). To the sum of these capacities must also be added that of the wiring, which may well be quite considerable if a screened lead is employed for the H.F. anode connection.

As the aggregate value of all these capacities cannot be reduced beyond a certain value, the obvious thing to do is to try to avoid transferring them in their entirety

THESE columns are reserved for the publication of matter of general interest arising out of problems submitted by our readers. Readers requiring an individual reply to their technical questions by post are referred to "The Wireless World" Information Bureau, of which brief particulars, with the fee charged, are to be found at the foot of this page.

to the tuned circuit, and in practice the simplest way of doing this is to "tap down" the anode connections to the tuning coil, as in Fig 1 (b). If we make a connection to the centre point of the coil, only one-quarter—and not one-half, as might be imagined—of the total capacities will be transferred. This plan is not likely to bring about any serious loss in magnification, and it will almost certainly confer an appreciable gain in selectivity.

It will be observed that, so far as long-wave reception is concerned, the anode connection to the tuned circuit is not "tapped down." To do this, it would be necessary to have a change-over switch in addition to the normal wave-range switch associated with the coil assembly. The absence of this refinement may not have any serious effect; stray capacities are seldom serious in their effects on the long waves, but the maintenance of accurate ganging may be doubtful unless it is added.

The Simplest All-mains Set

ALTHOUGH A.C. mains have advantages over D.C. when the design of a fairly ambitious receiver is in question, it is a fact that the D.C. user scores heavily if his requirements are confined to the simplest form of set. Due to the fact that a rectifier is not needed, the main source of complexity and expense at once disappears.

It is easy to dispose of a question raised by a reader who wishes to construct the simplest possible all-mains D.C. set for temporary use at short range with headphones. We can refer him to a complete design for a single-valve set of this type, which appeared in our issue of March 11th, 1931. The circuit diagram of this set is reproduced in Fig. 2; a "mains aerial connection" is shown in dotted lines, but where more sensitivity is needed an external aerial could be added.

Without attempting to discuss the circuit in detail, it may be stated that it is intended for operation on supplies of between 200 and 250 volts; the single valve is of the

general-purpose type designed primarily for battery feed, with a filament consuming 0.1 amp at 2 volts, and an ordinary electric lamp is employed to absorb the surplus mains voltage. For supplies between 200 and 220 volts, a 20-watt lamp will do, while for higher voltages of between 230 and 250 volts a 25-watt lamp should be substituted.

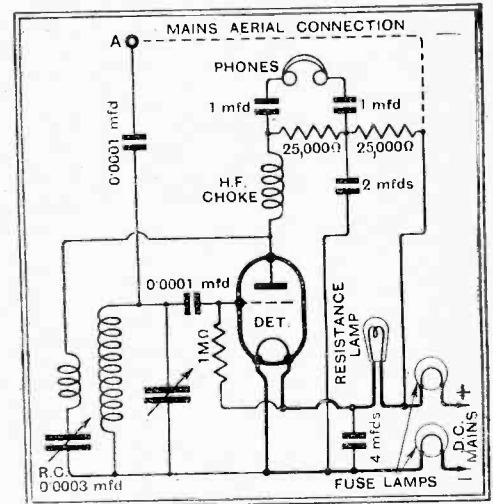

Fig. 2.—Power for nothing; the simplest possible all-mains set, with a voltage-reducing lamp which also provides illumination.

In order to combine safety with economy, the phones are fed through a resistance-capacity filter; another resistance-capacity arrangement is used for smoothing purposes, and will afford a sufficiently silent background on most mains supplies. Flash-lamp bulbs may be employed as safety fuses.

Microscopic Capacities

THE "top-end capacity" method of coupling a two-circuit tuner or band-pass filter is highly satisfactory, and, from the amateur point of view, has the special advantages of flexibility and cheapness. With this system the component circuits of the filter are linked together by a very small condenser joined between their high-potential ends. In order that the best coupling may be determined experimentally, it is usual for this condenser to be of the variable or semi-variable type.

It would appear to be necessary to stress the fact that the coupling condenser should be really small, and, most important of all, should have a low minimum capacity—not more than some 2 or 3 micro-microfarads. A maximum capacity in excess of 10 or 12 micro-microfarads is seldom needed. Further, it is a matter of some importance that the condenser should be wired in such a way that its connecting leads do not add appreciably to its minimum capacity; for instance, these leads should not be run close together and parallel to each other.

When correspondents who are using top-end coupling complain of broad and indefinite tuning, we always suspect that too much coupling capacity is being employed. This is almost certainly responsible for the troubles of a querist, who tells us that stations may be tuned in at two distinct settings, spaced by several degrees on the condenser dial. He is using a type of coupling condenser which we know to be suitable, and so we can only assume that the connecting leads are incorrectly arranged.

The Wireless World

INFORMATION BUREAU

THE service is intended primarily for readers meeting with difficulties in the construction, adjustment, operation, or maintenance of wireless receivers described in *The Wireless World*, or those of commercial design which from time to time are reviewed in the pages of *The Wireless World*. Every endeavour will be made to deal with queries on all wireless matters, provided that they are of such a nature that they can be dealt with satisfactorily in a letter.

Communications should be addressed to *The Wireless World* Information Bureau, Dorset House, Tudor Street, E.C.4, and must be accompanied by a remittance of 5s. to cover the cost of the service. The enquirer's name and address should be written in block letters at the top of all communications.

The Wireless World

THE
PRACTICAL RADIO
JOURNAL
22nd Year of Publication

No. 704.

FRIDAY, FEBRUARY 24TH, 1933.

VOL. XXXII. No. 8.

Proprietors: ILIFFE & SONS LTD.

Editor:
HUGH S. POCOCK.

Editorial Offices:
116-117, FLEET STREET, LONDON, E.C.4.
Editorial Telephone: City 9472 (5 lines).

Advertising and Publishing Offices:
DORSET HOUSE, TUDOR STREET,
LONDON, E.C.4.

Telephone: City 2846 (17 lines).
Telegrams: "Ethaworld, Fleet, London."

COVENTRY: Hertford Street.
Telegrams: "Cyclist, Coventry." Telephone: 5210 Coventry.

BIRMINGHAM:
Guildhall Buildings, Navigation Street, 2.
Telegrams: "Autopress, Birmingham." Telephone: 2970 Midland (3 lines).

MANCHESTER: 260, Deansgate, 3.
Telegrams: "Iliffe, Manchester." Telephone: Blackfriars 4412 (4 lines).

GLASGOW: 26B, Renfield Street, C.2.
Telegrams: "Iliffe, Glasgow." Telephone: Central 4857.

PUBLISHED WEEKLY. ENTERED AS SECOND
CLASS MATTER AT NEW YORK, N.Y.

Subscription Rates:

Home, £1 1s. 8d.; Canada, £1 1s. 8d.; other
countries abroad, £1 3s. 10d. per annum.

As many of the circuits and apparatus described in these
pages are covered by patents, readers are advised, before
making use of them, to satisfy themselves that they would
not be infringing patents.

CONTENTS

| | Page |
|---------------------------------------|------|
| PROGRAMMES FROM ABROAD, pp. 1-XXIV | |
| Editorial Comment | 115 |
| The Ferrocart III | 146 |
| Listening as an Art | 149 |
| Practical Hints and Tips .. | 151 |
| Q.P.P. With Triodes | 152 |
| News of the Week | 154 |
| Mutual Induction.. .. | 155 |
| New Automatic Bias Scheme .. | 157 |
| Lotus Four-valve A.C. Receiver | 158 |
| Laboratory Tests | 160 |
| Broadcast Brevities | 161 |
| Readers' Problems | 162 |

EDITORIAL COMMENT

Ferrocart

Importance of the New Coils

IN September, 1932, a stir was created in wireless circles by the publication in *The Wireless World* of the first information regarding a new type of radio frequency coil having an iron-content core given the name "Ferrocart," which had been developed by Hans Vogt, in Germany. We delayed to publish details of the new coils until we had made careful measurements ourselves to see if the claims made for them could be substantiated. The results obtained from our tests established beyond doubt the importance of the new principle, and the publication of the results of our measurements completely converted those who had, at first, been sceptical.

There has been little more that could be said on the subject until Ferrocart coils became available in this country. Some time has necessarily elapsed since our first announcement in September last year, before the task of the manufacturer of designing complete coils, with switching suitable for requirements in this country, could be completed. Coils have now been produced and are being put on the market, so that we are in a position to deal at once with this new coil principle in its practical application to the design of a complete receiver. Elsewhere in this issue a preliminary article on such a set, *The Wireless World* Ferrocart III, is included, and complete constructional details for building it will appear next week.

At this stage all we need say is that, even though we were prepared for exceptional results, the performance of this receiver has exceeded our own expectations. We believe we can say, with complete confidence, that in the matter of selectivity alone, quite apart

from other considerations, the Ferrocart III excels in performance any other known three-valve receiver. The coils themselves are almost unbelievably small, and are wound on bobbins little larger than the bobbins used for telephone ear-pieces. The saving of space with coils of this type is, in itself, important in certain applications, but the outstanding advantage of Ferrocart coils as applied to broadcast receivers is mainly centred around the very great increase in selectivity. So substantial is the progress made in this direction that one is inclined to wonder whether the straight set with Ferrocart coils has not been lifted on to the same plane as the superheterodyne, although we must not overlook the fact that Ferrocart coils also have their applications to enhancing the performance of the superhet—but this is another story.

Q.P.P. with Triodes

Matching Not Necessary

FROM the volume of correspondence which we have received, it would appear that a large number of readers are contemplating the conversion of the output stage of their existing battery sets to Q.P.P. By this means a very large increase of output can be expected as well as a reduced battery consumption. But there must be cases where the battery set user does not require "mains output," but feels the need for more than is obtainable from a single valve.

The smaller triodes in Q.P.P. give very pleasing reproduction in such cases, and the cost of conversion compared with that of pentodes is much lower, especially as matching is not essential.

An article dealing with this subject for the first time appears in this issue.

Announcing an Outstanding Receiver

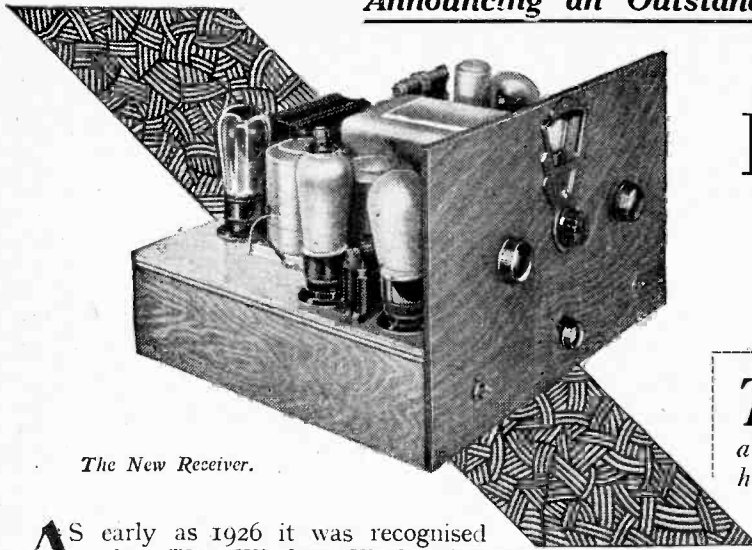

The New Receiver.

AS early as 1926 it was recognised by *The Wireless World* that efficiency in tuning coils was of fundamental importance to the practical realisation of high sensitivity and selectivity in a broadcast receiver. Large-diameter Litz-wound coils were developed, therefore, and they permitted for the first time a high degree of stable amplification to be obtained from a neutralised triode valve; they marked, in fact, the commencement of the era of effective high-frequency amplification.

The introduction of the screen-grid valve, however, made it possible to obtain the same amplification with coils of lower efficiency, and as selectivity was then of secondary importance, the large coils began to fall into disuse. Their abandonment was made complete by the necessity for complete screening in receivers, since their efficiency fell enormously when enclosed in a metal box of any reasonable dimensions, and they then proved little better than quite small solid wire coils.

The development of ganged tuning and built-in coil switching hastened this process, until coil design reached its present standardised form. These modern coils are much less efficient than their predecessors of seven years ago, but the exigencies of space prohibit the use of the latter, since no one would contemplate using three or four coils, each contained in a screening box measuring some 10 in. cube—dimensions which would be necessary to retain the full efficiency.

Reduced Coil Losses

The selectivity obtainable with the modern screened coil, however, has of late been becoming inadequate to deal with a congested ether, and the position appeared to be one of stalemate. Although an increase in coil efficiency was necessary to obtain the requisite selectivity, such an increase could not be obtained without making large increases in the coil dimensions, and this was prevented by limitations in the physical size of a receiver.

At this juncture, a new development made its appearance. It was discovered by Hans Vogt that if a coil were wound on a core consisting of very finely divided particles of iron, insulated from one another, the efficiency was increased to a remarkable extent. The introduc-

tion of the iron, of course, increased the losses due to the core, but so greatly increased the inductance that a much smaller quantity of copper wire was needed to maintain a normal inductance value. As a result, the copper losses were reduced to a greater extent than core losses were increased, and, on balance, the total resistance for a given inductance was reduced considerably. Not only this, it was found also that the physical dimensions could be reduced while still maintaining high efficiency.

A description of the new iron-core coils appeared in *The Wireless World* for September 16th, 1932, and in subsequent issues¹ the results of a series of measurements on them were published. These measurements fully confirmed the original claims, and it was shown that the efficiency of coils, smaller even than current practice dictated as the minimum, closely approached that of the early unscreened large-diameter Litz-wound inductances. It was at once evident that a very important advance had taken place.

At that time, however, nothing could be done to employ them in a receiver, for they were by no means fully developed and various manufacturing difficulties had to be overcome, and circuits designed to suit their characteristics. This initial work has now been brought to a satisfactory conclusion, and the new coils will now be available. The design of a suit-

¹ *The Wireless World*, September 30th and October 14th, 1932.

THE FERROCART III

Record Selectivity with the New Iron-cored Tuning Coils

THE introduction of ultra-efficient iron-cored tuning coils has at last made it possible to obtain from a simple straight set a degree of selectivity which bids fair to rival that of the super-heterodyne. To those accustomed to ordinary sets the selectivity given by the new coils is a revelation, and the principle undoubtedly opens out a new era in radio reception and will give a new lease of life to the straight set. In this article the theoretical considerations involved in the application of the coils to a receiver are discussed, and the complete constructional details of a three-valve A.C. set will appear in next week's issue.

able receiver has been proceeded with, therefore, and it may be said at once that phenomenal results have been obtained.

The mechanical form of the new Ferrocart coils can be seen from the drawing, and it closely resembles a miniature mains transformer. The coil for the medium waveband, the larger assembly, has a core built from "E" and "I" mouldings of Ferrocart, the windings are sectionalised, and Litz wire is used. The smaller long wave coil core is built from a pair of "L" shaped mouldings, and although the windings are still sectionalised, solid wire is employed. A small air gap is left at the joins in the mouldings of the core, and it is by the precise adjustment of this that matching is effected. The moulded bakelite base contains the waveband switching, and the coupling coils for a band-pass filter.

It will be seen, therefore, that we have now available coils of rather smaller dimensions than the accepted modern type, but which have an efficiency approaching that of large unscreened Litz-

wound air-core coils. It is only to be expected, therefore, that their application would raise a host of new problems.

The increased efficiency may be employed in two ways: it may be used to obtain improved selectivity, or to give increased amplification. Now it is evident that increased amplification is but rarely required, for experience shows that the sensitivity of the average present-day three-valve set is adequate for most

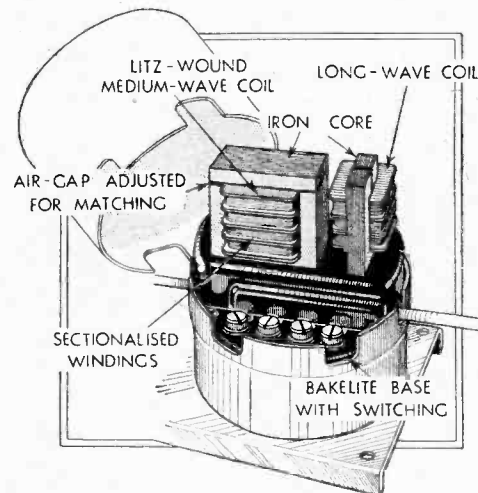

The construction of the new coils can clearly be seen in this illustration. The waveband switching and filter coupling coils are contained within the bakelite base.

The Ferrocart III—

requirements. Where such a receiver usually fails is on the score of selectivity. It is obvious, therefore, that the new coils should be used to remove the chief defect of existing sets, and that no improvement in amplification is justified if, as it must do, it involves any decrease in selectivity.

The aim in the receiver design, therefore, has been to obtain a maximum of selectivity while keeping the amplification at the normal figure obtainable with ordinary screened air-core coils. In order to do this, it is essential that all losses introduced by the circuit be kept at a minimum, and the choice of suitable components becomes quite limited. In addition, the sharper tuning renders ganging more critical, and necessitates the choice of a gang condenser with very accurately matched sections.

The choice of a circuit is also a matter requiring very careful attention, and that finally adopted is shown in Fig. 1. Fundamentally, it is in no way unusual, and it is only in the details that differences will be found. It must be realised that there is little object in producing a coil of abnormal efficiency if that efficiency is to be entirely destroyed by the circuit to which it is connected. The connection of a coil to any circuit, however, must inevitably introduce losses, and the problem becomes one of so arranging matters that these losses are kept to an absolute minimum.

This is primarily a matter of choosing all the components for their efficiency, but even when this is done, they must not be connected directly across the tuned circuits if losses are not to be prohibitive. It is necessary, in nearly every case, that the equivalent of a transformer coupling to the tuned circuit be adopted, for the losses

are then reduced by the square of the ratio used, and a very great gain is possible. In most cases an actual transformer connection is not used, but the equivalent, a tapping on the coil, is employed instead, since it is simpler.

The intervalve circuit, as may be seen from Fig. 1, is neither a simple tuned anode nor tuned grid circuit, but is of the type sometimes known as the tapped tuned grid circuit. Actually, in this case,

circuit, and a step-down transformer between the tuned circuit and the detector.

If ganging is to be accurately maintained, it is essential that the effective stray capacities remain the same on both wavebands; the turns ratio between the tapping and the whole coil must thus be the same on both wavebands, and switching is obviously called for. A single pole double-throw switch, therefore, changes over the tapping connection, while a make and break switch throws the long wave coil in and out of circuit as required.

In spite of the high ratios adopted in this tapping down, the damping on this intervalve circuit remains higher than is desirable, and a trace of reaction must be employed to remove this. To be successful, however, reaction must affect the tuning to a negligible extent, and it should remain fairly constant over the tuning range of the set. The anode circuit of the detector, therefore, is by no means unimportant, and the results obtainable from the H.F. side of the receiver are considerably affected by what is often con-

sidered to be a purely L.F. circuit. It is not, of course, for the detector handles both H.F. and L.F. currents.

It is important, therefore, to employ a suitable type of H.F. choke and the correct value of anode-cathode by-pass condenser. Moreover, it is necessary to insert a 500 ohms resistance in series with the reaction condenser and coil to prevent the possibility of the formation of parasitic oscillations on the long waveband, to obtain a smooth control, and to give a fairly constant setting to the control over the waveband.

It goes without saying that in these days the input circuit would take the form of

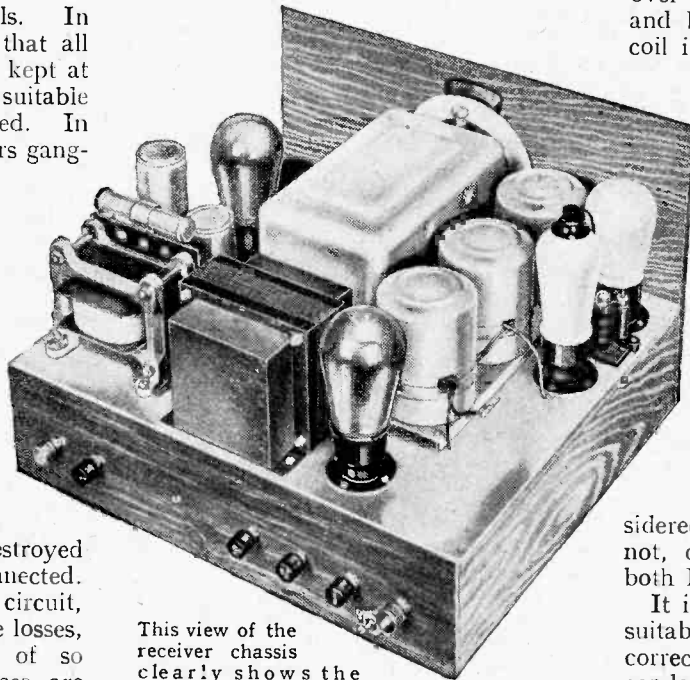

This view of the receiver chassis clearly shows the screened Ferrocart coils at the side of the gang condenser.

the connections to both the anode of the H.F. valve and the grid of the detector are tapped down, and as it has been found possible to use the same ratio for each, a single tapping serves the purpose. The action is thus that of a step-up transformer between the H.F. valve and the tuned

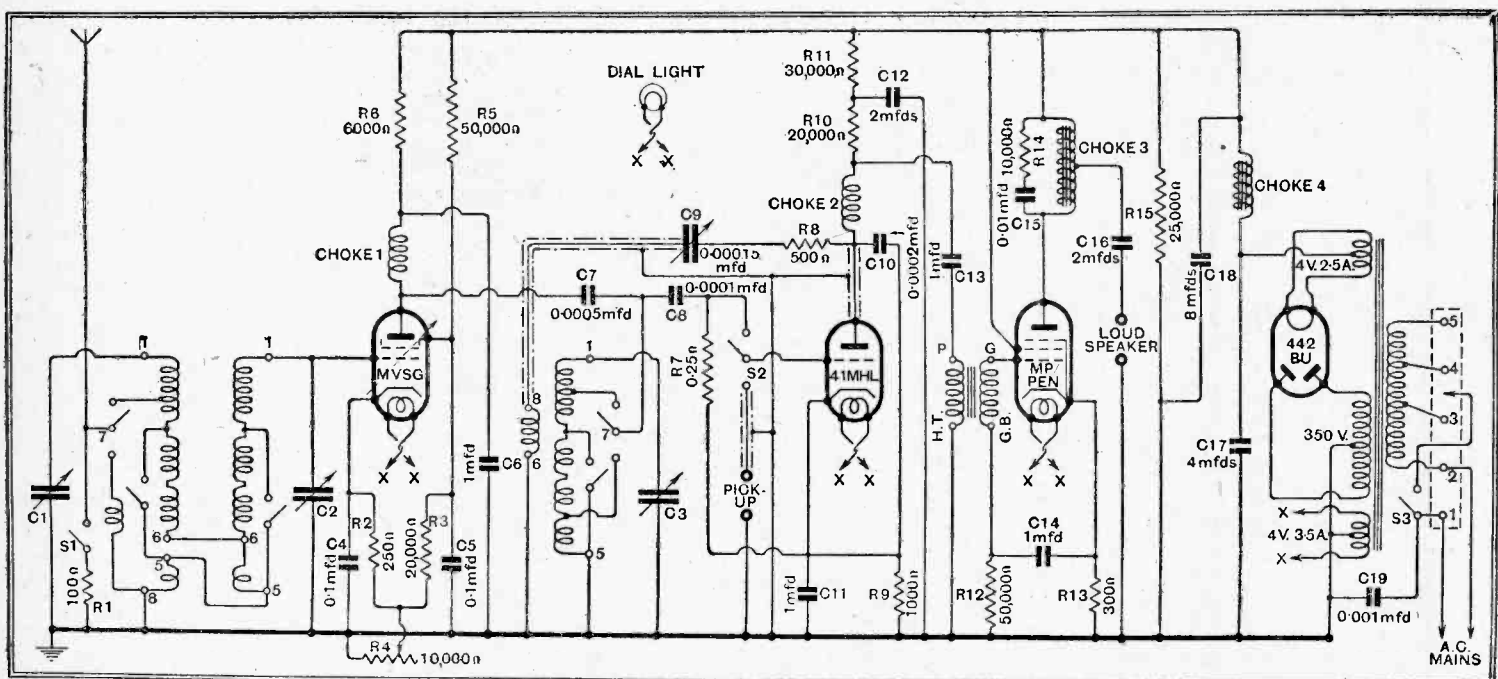

Fig. 1.—The circuit of the receiver with Ferrocart coils is fundamentally the same as that of an ordinary set, and the differences lie chiefly in preventing damping of the coils. A high-resistance smoothing choke is used, so that it may be replaced by a speaker field.

The Ferrocart III—
 a band-pass filter. The precise arrangement of this, however, is rather different from usual, for common inductance coupling has been adopted. In order that the overall selectivity should remain more or less constant through the wave range, it is desirable that the filter should have a single peaked resonance curve for wavelengths up to about 300 metres, after which the familiar double-humped curve should make its appearance, and the peak separation remains sensibly constant at all higher wavelengths. With ordinary coils, a mixed filter is necessary to obtain this result, but with Ferrocart it can be ob-

LIST OF PARTS

After the particular make of component used in the original model, suitable alternative products are given in some instances.

FERROCART III

- 1 3-gang condenser, 0.0005 mfd., with right-hand trimmers British Radiophone
- 1 Dial and dial light assembly British Radiophone
- 1 Reaction condenser, differential or straight, 0.00015 mfd., C9 Formo 23c
(Polar, Ormond)
- 1 Set of Ferrocart coils Colvern
- 2 H.F. chokes, Ch1, Ch2 McMichael "Binocular Junior"
- 4 5-pin Valveholders Clix chassis-mounting type
(Eddystone)
- 1 Volume control, 10,000 ohms, R4 Colvern ST5
(British Radiophone, Igranic, Watmel)
- 1 Electrolytic condenser, 4 mfd., C17 T.C.C. type 802
- 1 Electrolytic condenser, 8 mfd., C18 T.C.C. type 802
- 2 Fixed condensers, 2 mfd., 250 v. D.C. working, C.12, C.16 T.C.C. type 65
- 1 Fixed condenser, 1 mfd., 250 v. D.C. working, C.14 T.C.C. type 65
- 2 Fixed condensers, 0.1 mfd., non-inductive, 400 v. D.C. test, C4, C5 T.C.C. type 50
- 3 Fixed condensers, 1 mfd., non-inductive, 400 v. D.C. test, C6, C11, C13 T.C.C. type 50
- 1 Fixed condenser, 0.0005 mfd., C7 T.C.C. type 34
- 1 Fixed condenser, 0.0001 mfd., C8 T.C.C. type 34
- 1 Fixed condenser, 0.0002 mfd., C10 T.C.C. type 34
- 1 Fixed condenser, 0.01 mfd., C15 T.C.C. type 34
- 1 Fixed condenser, 0.001 mfd., mica, 1,000 v. D.C. test, C19 T.C.C.
(Dubilier)
- 2 Q.M.B. make-and-break switches, S1, S3 Bulgin S80
- 1 Q.M.B. change-over switch, S2 Bulgin S81
(British Radiophone, Claude Lyons)
- 1 Pentode output choke, Ch3 Telsen power type W172
- 1 2,500 ohms speaker field replacement choke, Ch4 Sound Sales
(Scott Sessions)
- 1 Mains transformer, screened primary, 350-0-350 v. 60 mA, 4 v. 2.5 amp. C.T., 4 v. 3.5 amp. C.T. Bryce
(Challis, Parneko)
- 1 L.F. transformer Lewcos type L.F.T.4
(Varley)
- 1 Resistance, 100 ohms, R1 Graham Farish "Ohmite"
- 1 Resistance, 250 ohms, R2 Graham Farish "Ohmite"
- 1 Resistance, 300 ohms, R13 Graham Farish "Ohmite"
- 1 Resistance, 500 ohms, R8 Graham Farish "Ohmite"
- 1 Resistance, 1,000 ohms, R9 Graham Farish "Ohmite"
- 1 Resistance, 6,000 ohms, R6 Graham Farish "Ohmite"
- 1 Resistance, 10,000 ohms, R14 Graham Farish "Ohmite"
- 2 Resistances, 20,000 ohms, R3, R10 Graham Farish "Ohmite"
- 1 Resistance, 30,000 ohms, R11 Graham Farish "Ohmite"
- 2 Resistances, 50,000 ohms, R5, R12 Graham Farish "Ohmite"
- 1 Resistance, 250,000 ohms, R7 Graham Farish "Ohmite"
- 1 Resistance, 25,000 ohms, 3 watts, R.15 Graham Farish "Ohmite"
Power type "HD"
(Dubilier, Erie, Claude Lyons)
- 1 5-way Connector Wilburn
- 6 Terminals, aerial, earth, L.S.+, L.S.-, 2 pick-up (Belling-Lee, Elex, Igranic) Clix type "B"
- 1 Plymax baseboard, 14in. x 12in. x 3/16in. Peto-Scott
(Prepared Metal Base Plate, bent and drilled Colvern)
- Panel, oak-faced ply, 9in. x 14in. Peto-Scott
- 2 Lengths screened sleeving Harbros
(Gollone, Lewcos)
- 2 ozs. 20 tinned copper wire, wood, 6 lengths sistoflex, etc.
- Screws: 14 3/16in. No. 4 R/hd.; 4 1/4in. No. 6 R/hd.; 20 1/2in. No. 4 R/hd.; 4 3/16in. No. 4 R/hd.; 12 1/4in. No. 4 R/hd.
- Valves: 1 MVSG, 1 41MHL, 1MP/PEN, 1 442BU Cossor

tained with a simple inductance coupling owing to the different law of variation of H.F. resistance with frequency.

It is further necessary that the aerial coupling to the first circuit be effected in such a manner that the coupling is truly to the first circuit only, and not to the secondary also. On the medium waveband, little is necessary in the way of precaution when a loose aerial coupling is used to provide selectivity, since the effects of a moderate degree of secondary circuit coupling are swamped by the remaining coil resistance. This is not the case on the long waveband, however, and if the resonance curve is to approach symmetry, it is essential to employ a separate aerial coupling coil. On both wavebands, the coupling is so adjusted that the aerial load on the secondary remains the same and is as small as possible, so that ganging remains accurate; it is actually affected by the aerial to an unusually small degree.

When these circuits are correctly designed, the remainder of the receiver can follow standard practice, and in the set to be described a variable-mu H.F. valve has been used with a power grid detector and a compensated pentode output valve. The mains equipment has a larger output than usual so that it is readily possible to energise a moving-coil loud speaker if desired and a high degree of smoothing is incorporated.

The improvement in performance which this receiver shows over a similar type fitted with ordinary coils is so great that it can be realised only by actually handling the set, and in words alone it is difficult to convey an adequate impression. In sensitivity and quality of reproduction the receiver is well up to standard, and it

is in selectivity that the performance is so outstanding. It is no exaggeration to say that the selectivity is considerably greater than that given by the average two-H.F. set with four tuned circuits, and among commonly employed receivers it is exceeded only by that of the superheterodyne.

The fact that within nine miles of Brookmans Park, with a good outdoor aerial and while the two locals were working, some seventy medium wave distant stations were received, speaks volumes for the performance. Algiers, separated from the London Regional by only 18 kc., could be received with only moderate interference, and Hamburg, some 26 kc. away, was obtained with no audible interference.

When it is remembered that under the same conditions of test an ordinary three-valve set will not permit any station between the Midland and the London Regionals to be received properly, some idea of the magnitude of the improvement can be obtained. The selectivity of all straight sets falls off somewhat at the lower wavelengths, but this is much less than usual with Ferrocart coils, and it is particularly striking to find that Turin, on 1,096 kc., and Trieste, on 1,211 kc., are both quite clear of the London National on 1,147 kc. The average spread of this station is thus about six channels on either side. Stations closer to London than this can be well received, but there is some liability to interference during quiet passages in the desired programme.

A list of the parts required for the new receiver is given herewith, and full constructional details of the set itself will appear next week.

THE BRUSSELS NOTEBOOK

Wavelength Variations During January

THE first report on the wavelength vagaries of Empire stations issued in 1933 by the Brussels checking station recalls the time before the Prague Plan scheme came into force. Stations seem to be piled on top of each other, and a surprising feature is that some of the offenders who have transgressed by 7 or 8 kilocycles have formerly been notable for their stability.

Conditions on the long waveband are unchanged except for one new station working on the same wave as Kaunas. The newcomer is the Roumanian station, Craciunelu. Telegraphy stations are causing more trouble. Daventry 5XX is behaving very badly, as it has now developed a second harmonic on 385.6 kc., next to its third on Vienna and its seventh among the Scandinavian relays. Moscow and Leningrad's harmonics continue as lustily as ever.

Medium Wave Offenders

Trouble is most rife on the medium waveband. Tartu, the Finn, has encroached into forbidden ground and was last heard on 510 kc., perilously close to the SOS wave, 500 kc. Even sorely tried Ljubljana avoids the danger wave by at least 20 kc. Tampere used Budapest's wave-

length for two days, and Riga interfered for two days with Munich, so that that station, which is permanently heterodyned by Palermo, was nearly wiped out. Between 644 kc. and 671 kc. no fewer than sixteen stations were working, including, of course, those on the international common wave of 662 kc.

New Wave Plan Tests?

Madona, the Latvian play, was to be found on 662 kc., and also Agen, the French station, which has been rebuilt after destruction by floods. Leipzig was free from Archangelsk for a week or so while the latter was experimenting with the wavelength shared by Toulouse and Stalino, but towards the end of the month the station showed a preference for Leipzig's wave. Posen, hitherto a steady station, trespassed on Milan's wavelength for two days, and Hilversum likewise offended by interfering with Limoges-Kosice. Frankfurt jostled Hörby for one day. It is believed that these inexplicable changes are in connection with tests for a new wave plan upon which the council of the International Broadcasting Union are busy preparing for submission to the postal administrations.

Listening as an Art

Do we Make the Most of What we Hear?

By A LISTENER

LISTENERS vary considerably in "quality"; in other words, different people, possibly of equal acuity of hearing, differ in their respective abilities to follow reproduced sounds, especially speech. The differences are, perhaps, more noticeable in the case of speech, since the spoken word is the normal and standardised vehicle of human communication. It is hardly possible to assess or standardise the impression conveyed by music. Domestic listening with several people often provides examples of the difference of quality between listeners; so, also, do the talkies. To a considerable extent, of course, this difference may be a matter of custom in listening to reproduced sounds, so that a certain added facility of listening is acquired. On the other hand, broadcast listening is now of so many years' standing that one would have thought that most people—certainly most listeners—would have acquired an art of listening.

The efforts of broadcasting technicians—production and engineering alike—are devoted chiefly to getting the greatest naturalness into their broadcast matter. At the listener's end the greatest appreciation of the broadcast efforts is, to a large extent, within the listener's own control—that is, assuming a good set and loud speaker, which are essential before

SO much time is spent in discussing the art of broadcasting—such questions as the correct use of the microphone and the right studio acoustics—that we are in danger of forgetting the listener's share in the proceedings. The finest broadcast fails if it falls on inattentive ears or ears which, for a variety of reasons, are unable to do justice to what is offered them.

influenced as it is by factors both physiological and psychological. For these advances the development and popularity of broadcasting have undoubtedly been largely responsible.

Not long ago there appeared in an American magazine of the "popular technical" class a short series of rules for broadcast listening. They are well worth quoting: (1) The room should be of fair size with plenty of rugs, curtains, books, etc., and with few unbroken wall-spaces; (2) listeners should sit directly in front of the loud speaker, usually at a distance of five to ten feet; (3) the receiver should be adjusted to moderate volume; if the announcer's words are intelligible in the far corners of the room the volume is usually about right; (4) avoid interruptions and discontinuities—once the volume and tuning controls are adjusted they should be left alone during the programme; (5) keep quiet—shut windows on noisy streets, etc., and avoid conversation; (6) the room should be dimly lit, with no actual lamp—not even the pilot lamp of the receiver—visible to any listener; (7) choose a comfortable chair and wear comfortable clothes.

These rules are possibly idealised, but there is a good deal of reason in them all.

The first is based on acoustic principles. Flat unbroken surfaces reflect the sound waves and cause echoes and reverberations; soft hangings, carpets, chairs, and even books all tend to absorb them and give less echo.¹ Clothes and the bodies of

¹This subject was dealt with at length by W. H. O. Sweeny in *The Wireless World* of January 20th, 1933.



Listeners vary considerably in "quality."

listeners have the same effect. For example, it has been estimated that an audience in an auditorium has about the same effect as would a series of feather beds spread over the seats. Too complete absorption gives a "dead" effect, but too much echo is the more likely and therefore the more to be watched.

The second rule is based on the fact that loud speakers mostly send out their waves in a beam or cone, which, incidentally, may vary for different frequencies. As regards the third rule, moderate volume obviously avoids distortion in set or speaker. The suggested criterion should have the general effect that peaks of loudest sounds are not such as to give detectable distortion.

The fourth rule, about interruptions, is merely the common sense of any sort of listening, and applies to broadcast just as it does to theatre or concert. Undue meddling with the controls is a common complaint of many domestic "experts," and is irritating and distracting to the rest of the household. The same general common sense applies also to the fifth rule, since any form of extraneous noise is naturally detrimental to the hearing of the programme. This, of course, assumes that the programme is worth listening to!

Talking and Listening

Here it may be interpolated that many people keep their sets switched on when they are not listening. We read from time to time of "wireless nerves." No doubt they are quite real, but are mostly due, not to obscure or magic effects of ether waves upon our systems, but to the irritation to which many people willingly expose themselves by listening to wireless and to other things at the same time. You must all know some friend—or fiend—who keeps the wireless on, usually at full volume, during conversation when nobody is listening to it, getting everybody, including, one hopes, himself, worked up into a state of nerves.

But this is aside. Certainly, for serious listening to a programme, the fifth rule is absolutely sound.



Interruptions should be avoided.

any reproduced matter can really be appreciated. The enjoyment of broadcast programmes is largely an æsthetic matter, but so many technical conditions govern the possibility of æsthetic appreciation that the subject comes reasonably within the scope of a technical journal.

Considerable advances have been made in the past few years in the general science of acoustics and in linking up the physical side of the subject with the human side,

Listening as an Art—

This (fifth) rule about silence also borders on to matters jointly physiological and psychological, both of which enter prominently into the last two rules. For example, the sixth rule about dim lighting is based on what appears to be a proved psychological fact, described, broadly, as "mixture of the senses." It is generally known and agreed that the final appreciation of the various senses lies, not in the particular sensory organ concerned, but in the brain. As a result, it appears that if the brain is busy with one sense it is less able to be stimulated by another.



Friend or fiend?

Examples are found in underground railways. Measurement of the absolute intensity of sound have revealed that, although the noise-level in a dim subway was actually less than in the open street, most ears found it greater. This is explained by the suggestion that in the dim light of the subway the eye is less strongly stimulated than in the daylight of the street, and that the ear—or, rather, the brain through the ear—is more actively affected by sounds of less strength. Similarly, the sense of touch can be measured by an appropriate instrument, and it has been found that subjects have shown decreased delicacy of touch when listening intently to a sound or when, in a brightly lit room. This no doubt explains the apparent enhancement of the other senses manifested by blind people.

An application of this fact is found in the sixth rule (about lighting). It is certainly a fairly normal experience that for best and most intent "listening" the room should be dimly lit—even dark. Have you ever tried closing the eyes when engaged in a trying long-distance trunk call?

Another fact in connection with lighting, also, is that dim illumination undoubtedly helps the listener to create his own imaginative background to the "heard" broadcast. The double broadcast of "Rope," for example, gave an excellent opportunity of trying the experiment of two degrees of lighting, and the effect was quite convincing. On that memorable Armistice night when "Journey's End" was broadcast a dim fire-glow permitted the conjuring up of a setting that differed but little from that of the stage presentation seen a few weeks later. Numerous other examples will readily occur to any listeners who have tried a like experiment. When the B.B.C.

advises a dim background it is worth while to try their advice, also to do the same on many occasions when they do not.

The same reasoning of the "mixture of the senses" is the basis of the last rule, about comfort. It is beyond doubt that definite distraction occurs with positive bodily discomfort, to say nothing of actual pain. But an exaggeration of skin sensations, even if they do not amount to conscious discomfort, may have an effect on the brain similar to that of strong light or any other sensory stimulus, and thereby render it less active to the auditory sense. Whether or not this is of sufficient importance to justify the development of special "broadcast wear" must lie with the listener and his own sense of comfort, or his ability to indulge it. Various accessory aids to comfort can readily be imagined!

Whether or not the whole of these rules are worth regarding must obviously depend on the listener's earnestness and desire to follow the particular programme. For certain types of programme, just as for certain types of listening community, they are obviously extravagant. For other types they are equally obviously of definite advantage.

How Imagination Helps

In the present stage of broadcasting we are dependent on the one sense, that of hearing, and on obtaining from it the maximum reality that we can. This despite the developing technique of television. To put it in another way,



Special "broadcast wear"

with a good modern set and speaker it is not difficult to obtain in a room (or, at any rate, at our ears) a degree of sound comparable to that which we might have in the studio or hall. Television is still a long way off from giving us, on a domestic scale, a size of visible image commensurate with that which is so easily obtained aurally.

From many generations of acquaintance with the printed word we, or at least some of us, have developed the faculty of imaginative reading, or of conjuring up an imaginative background which is at least highly satisfactory to ourselves. Have we yet carried that imagination as far towards the art of listening?

DISTANT RECEPTION NOTES.

YOU may have noticed that Leipzig's strength is not quite what it was. The reason is quite simply that the station is now using only about 80 instead of its full 120 kilowatts. I have seen it stated that the reduction was made on account of the swamping caused to those on neighbouring wavelengths, but this, I believe, is not correct. What actually happened was that with the full power in use it was found that the quality was none too good. After a series of experiments it was discovered that the station's service area could be amply covered and the quality vastly improved by reducing power.

That the quality of the transmissions is definitely very much better with the smaller power output there is no doubt. The difficulty probably arises in connection with the amplifiers between the low-power modulator and the output stage.

Speaking of high-powered stations reminds me that I have just received direct from the head of the Cincinnati, Ohio, station WLW, the astonishing information that by the end of the present summer a new 500-kilowatt transmitter will probably be at work. The Federal Radio Board's sanction has been received, all contracts have been completed and constructional work has already begun. The new transmitter will use the present WLW wavelength of 428.3 metres, a particularly favourable one for long ranges since it is not prone to fading.

Will U.S. Heterodyne Us?

One of the most interesting features about the new station will be the "vertical radiator." This is to have a height of 840 feet, and it is calculated that its use alone will increase the service area radius of a station by twenty-five per cent. With 500 kilowatts at their command and the vertical radiator the engineers of WLW are expecting a service area with a radius of 2,500 miles.

One rather dreadful thought is that if the American station does prove to have considerable field strength in this country it may cause trouble by heterodyning both Madrid Union Radio and Belgrade, both of which will be in the high-powered class before next autumn.

I do not know whether Trieste uses occasionally more than the 10 kilowatts with which it is officially credited, but on several occasions recently this station has been received at phenomenal strength. I have had it as early as four o'clock in the afternoon with volume not very much less than that of the local. Another wonderful station at the moment is Breslau.

For some reason or other Huizen (Hilversum programmes) is very much under the weather just now. This is surprising since other long-wave stations are in excellent form.

Of the medium-wave stations the best are Brussels Nos. 1 and 2, Munich, Florence, Prague, Langenberg, Rome, Katowice, Leipzig, Toulouse, Strasbourg, Milan, Breslau, Hilversum (Huizen programmes), Turin, Trieste, and Fécamp.

Hamburg shows a wonderful improvement, and Berlin Witzleben is nearly always worth attention. Lyons Doua is good on most nights, despite its official rating of 1.5 kilowatts only, and Genoa is now much better heard. D. EXER.

Practical HINTS AND TIPS

AIDS TO BETTER RECEPTION

IT is often convenient to be able to adjust a semi-variable condenser of the compression type without the need for delving into the interior of the set. At least one make of condenser (the Cyldon) may be mounted so that the regulating-screw head registers with a hole previously drilled through the floor or side of the cabinet in such a way that access for adjustment is obtained through this hole.

Inverted Condensers

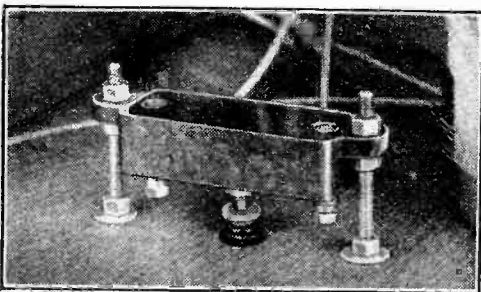

A semi-variable condenser, mounted so that adjustments may be made externally.

Without any very great difficulty, other types of condenser may be mounted so that adjustments may be made in this way, and a suggested method of mounting is shown in the accompanying illustration. Short lengths of 4 B.A. threaded rod act as supports to the condenser; the hole through which adjustment is made should be just large enough to afford clearance for the knob, which, of course, must be slotted to take a screw-driver.

IT is a fact that the great majority of modern receivers of the type designed for battery feed will work satisfactorily when fed with anode current from an eliminator. This holds good even if "free" grid bias is included in the receiver; although anode voltages will generally be higher than when batteries are used, the bias system will be sufficiently self-compensating to make good any discrepancies that are likely to occur.

Disturbing Free Bias

But care should be taken to see that nothing is done to frustrate the intentions of the designer with regard to the various currents that will flow through the bias resistor. In battery sets it is usual to feed the screening grid of an H.F. valve from an extra tap on the H.T. battery; with an eliminator, a regulating potentiometer, either of the fixed or variable type, is generally necessary for this circuit. If the screening grid potentiometer be included in the receiver, the extra current that it consumes will pass through the bias re-

sistor, and so any valves which are biased by the voltage drop across this resistor will be working under more or less incorrect conditions.

This state of affairs may be avoided by installing the feed potentiometer as part of the eliminator and not as part of the set. The extra current which it consumes will not pass through the bias resistor if this plan be adopted. Of course, many eliminators already include provision for critical control of screening-grid voltage, and so no special precautions are necessary.

THE adjusting screw of a trimming condenser (built into a ganged tuning condenser) is invariably in electrical connection with the "earthy" side of the circuit, and, in consequence, there should be, theoretically, no risk of disturbing tuning by body-capacity effects while these trimmers are being adjusted.

A Trimming Tool

But occasionally it will be found that, in order to make the adjustment, the metal shank of a screw-driver may come into sufficiently close proximity with high-potential connections or components to introduce a change in the tuning of the associated circuits. In this way misleading effects may be encountered, and it is not a bad plan to make a special trimming tool. This device is nothing more than a screw-driver with the shortest possible metal blade, and a fairly long handle of insulating material—wood is quite good enough for this purpose.

As trimmer adjusting screws generally turn quite freely, it may be quite permissible to avoid the use of metal altogether, and to make a special screw-driver with some such insulating material as a strip or rod of bakelite, paxolin, or ebonite.

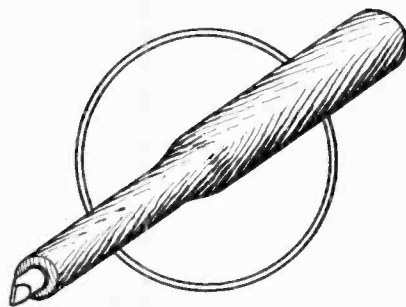

A simple form of insulated screwdriver, for adjusting trimming condensers. It is supplied with certain H.M.V. radio-gramophones.

When dealing with circuits where adjustments are exceptionally critical, it is perhaps worth while to take some pains to see that the screw-driver blade shall be an exact fit in the slot of the adjust-

ing screw. If this is done all backlash is avoided, and it will be found that adjustments can be made more accurately, and certainly much more easily, than when the width of the slot is considerably greater than the width of the blade. This is a point worth while remembering when making initial adjustments to the Station Finder.

THERE must be many sets using manufactured coils of the standard type (tuning coil, with tapping or separate primary winding for aerial, and also a reaction winding) as the tuned-anode coil of an H.F. valve, reaction being applied from the detector anode circuit.

A Simple Selectivity Device

Here, ready to hand, is a means of increasing selectivity with these coils. Instead of using the whole coil in the anode circuit, connect

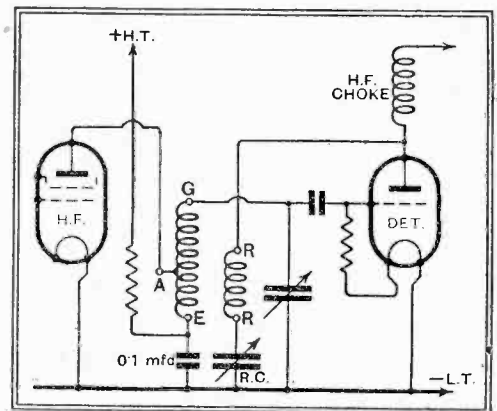

Fig. 1.—By joining the preceding anode to the "aerial" terminal of a standard coil, selectivity is improved.

the anode of the H.F. valve to the terminal marked "Aerial" of the coil (as in Fig. 1). The method thus applied is identical to that universally used to obtain selectivity between the aerial and input tuning circuit. The result will be an enormous increase in selectivity, accompanied by a relatively small drop in signal strength.

What happens is briefly this: The anode circuit impedance is reduced considerably, giving a lessened oscillatory p.d. across its portion of the coil. The tuned circuit is more or less loosely coupled to this coil. The fact of loose coupling has, however, reduced the damping effect of the preceding valve in proportion to the turns ratio. Thus the reduction in applied volts is to some extent compensated for by an increase in current, since current in a resonant circuit depends on the damping present. On the other hand, selectivity is gained, both due to the reduction in damping of the tuned circuit and to the loose coupling.

READERS' PROBLEMS

THESE columns are reserved for the publication of matter of general interest arising out of problems submitted by our readers. Readers requiring an individual reply to their technical questions by post are referred to "The Wireless World" Information Bureau, of which brief particulars, with the fee charged, are to be found at the foot of this page.

Reaction Circuit Connections

THERE need be no hesitation in mounting a reaction condenser in the most convenient operating position. Even though this procedure may necessitate long connecting leads, all risk of instability may be avoided by shielding these wires.

Similarly, when there is any suspicion that instability is due to long reaction leads, the experiment of shielding these leads may be tried with confidence; the effect of doing so is most unlikely to be in any way prejudicial to the operation of the set.

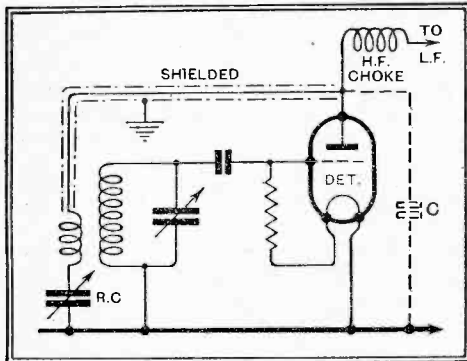

Fig. 1.—The use of a screened lead for the reaction circuit connection has no other effect than the addition of a small capacity (C) between detector anode and earth.

This is in answer to a correspondent who finds that his "2 H.F." set can be stabilised by disconnecting the reaction control circuit; he has satisfied himself that the trouble is not due to the use of a reaction condenser with an excessively high minimum capacity.

This correspondent goes on to ask whether the use of a screened lead to the reaction coil and condenser is likely to have any untoward effects; he is particularly anxious to know whether the extra capacity of the shielded connection is likely further to restrict the tuning range of the receiver.

We would certainly recommend him to try the effect of shielded connections. He can rest assured that the tuning range of the set will not be restricted; in effect, the capacity of a shielded lead from the detector anode will be additive to that already existing between the anode of the detector valve and earth. In this position, a capacity in the neighbourhood of 0.0003 mfd.—much more than that of a shielded lead—is likely to be actually beneficial.

The use of a shielded lead between the reaction coil and the "live" side of the reaction condenser will increase slightly the minimum capacity of the condenser; this is most unlikely to prove an unsurmountable drawback.

Erratic Volume Control

DESCRIBING the operation of his volume control, a correspondent tells us that loudness of reproduction is increased progressively until the potentiometer slider reaches a point a few degrees from the end of its travel. After this point there is a slight, but clearly perceptible, falling-off in volume.

A variable- μ valve is used in the receiver, and, according to a circuit diagram submitted by our querist, volume control is effected in a fairly conventional way by variation of the bias applied to this valve. But the usual limiting resistance has been omitted, with the result that when the potentiometer slider is at the "maximum" position, the grid is at zero potential, or at the same potential as the cathode.

This explains the effect described, and we think there can be no doubt that the falling-off in sensitivity is due to the flow of grid current, which imposes a certain amount of damping on the input circuit. As a general rule, maximum sensitivity will be obtained when the grid of the H.F. valve is made just sufficiently negative to prevent the flow of grid current.

"Monodial" Heater Voltage

IN the "A.C. Monodial," current for the indirectly heated valves in the receiver unit is fed through fairly long leads from the power supply unit; it is therefore a matter of some importance that the ohmic resistance of these leads should be low, and, accordingly, in order to prevent undue loss of voltage, two pairs of parallel interconnecting wires were employed. The resistance of these leads is so small that the drop in voltage should amount to very little more than a tenth of a volt, which is negligible.

A reader tells us that he has borrowed a dependable A.C. voltmeter, and finds that the voltage existing across the heaters of his own "Monodial" amounts to very little more than 3.6 volts; he goes on to say that the L.T. voltage measured directly across the transformer terminals is rather over than under 4 volts. He asks whether this indicates an excessive loss of voltage.

We are afraid that it does, and we advise him to lose no time in replacing the inter-unit L.T. leads by others of considerably greater cross-sectional area.

Paralleled Transformer Windings

IT is hardly to be advised that two or more of the separate L.T. windings of a power transformer should be connected in parallel. If the "sense" of the two interconnected windings be incorrect, they would act more

or less as a short-circuit, and there is a grave risk that the transformer would be burnt out.

Information on this subject is asked for by a reader who wishes to feed six indirectly heated A.C. valves from an existing transformer which has one L.T. winding rated at 4 volts 4 amps., and another at 4 volts 2½ amps. His proposal is to connect all the heating elements of the valves across these two windings after they have been joined in parallel.

Rather than run the risk of damaging his transformer, we suggest that four of the valves should be fed from the 4-amp. winding, and the remaining two from the other. The centre taps of both windings will, of course, be joined to the common earth line in the usual way.

Coupling Condenser Capacity

JUDGING from letters that have recently been received, there appears to be some uncertainty as to the precise effect of using, in a resistance-capacity amplifier, a coupling condenser of smaller capacity than is usually specified. The condenser in question is that marked C in Fig. 2.

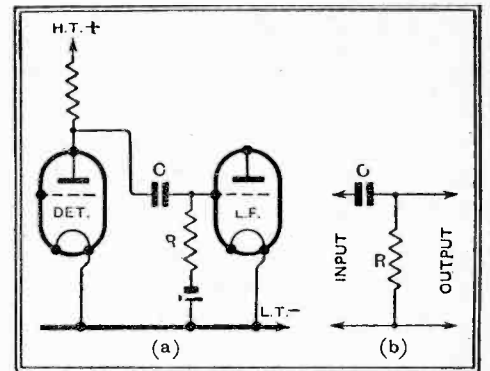

Fig. 2.—A resistance-coupled stage, and (diagram b) the equivalent circuit to show the effect of the coupling condenser.

Used in this position, too small a condenser will have the effect of attenuating proportionately the lower register in relation to the higher audible frequencies.

This is easy to understand if one regards the coupling condenser and its associated grid leak (R in the diagram) as a potential divider connected the source of input voltage—in this case the anode circuit of the preceding valve. The equivalent circuit, so far as these components are concerned, has been redrawn in Fig. 2 (b). Voltages developed across the condenser are wasted, and only those developed across the grid leak are passed on to the succeeding valve to do useful work.

Now the reactance of a condenser varies with frequency, and the proportion of signal voltage dissipated (and wasted) across the condenser limb of the potentiometer is much greater for low notes than for high; frequency distortion is in this way introduced unless the condenser has a sufficiently high capacity in relation to the grid-leak resistance.

The Wireless World

INFORMATION BUREAU

THE service is intended primarily for readers meeting with difficulties in the construction, adjustment, operation, or maintenance of wireless receivers described in *The Wireless World*, or those of commercial design which from time to time are reviewed in the pages of *The Wireless World*. Every endeavour will be made to deal with queries on all wireless matters, provided that they are of such a nature that they can be dealt with satisfactorily in a letter.

Communications should be addressed to *The Wireless World* Information Bureau, Dorset House, Tudor Street, E.C.4, and must be accompanied by a remittance of 5s. to cover the cost of the service. The enquirer's name and address should be written in block letters at the top of all communications.

Practical HINTS AND TIPS

AIDS TO BETTER RECEPTION

IT is often convenient to be able to adjust a semi-variable condenser of the compression type without the need for delving into the interior of the set. At least one make of condenser (the Cyldon) may be mounted so that the regulating-screw head registers with a hole previously drilled through the floor or side of the cabinet in such a way

that access for adjustment is obtained through this hole.

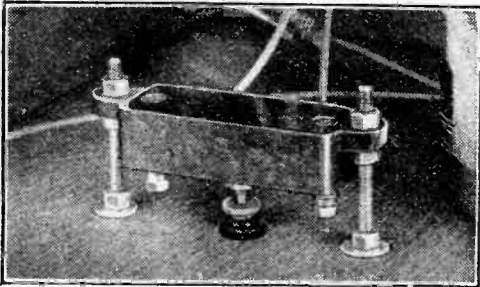

A semi-variable condenser, mounted so that adjustments may be made externally.

Without any very great difficulty, other types of condenser may be mounted so that adjustments may be made in this way, and a suggested method of mounting is shown in the accompanying illustration. Short lengths of 4 B.A. threaded rod act as supports to the condenser; the hole through which adjustment is made should be just large enough to afford clearance for the knob, which, of course, must be slotted to take a screw-driver.

IT is a fact that the great majority of modern receivers of the type designed for battery feed will work satisfactorily when fed with anode current from an eliminator. This holds good even if "free" grid bias is included in the receiver; although generally anode voltages will be higher than when batteries are used, the bias system will be sufficiently self-compensating to make good any discrepancies that are likely to occur.

But care should be taken to see that nothing is done to frustrate the intentions of the designer with regard to the various resistors that will flow through the bias resistor. In battery sets it is usual to feed the screening grid of an H.F. valve from an extra tap on the H.T. battery; with an eliminator, a regulating potentiometer, either of the fixed or variable type, is generally necessary for this circuit. If the screening grid potentiometer be included in the receiver, the extra current that it consumes will pass through the bias re-

sistor, and so any valves which are biased by the voltage drop across this resistor will be working under more or less incorrect conditions.

This state of affairs may be avoided by installing the feed potentiometer as part of the eliminator and not as part of the set. The extra current which it consumes will not pass through the bias resistor if this plan be adopted. Of course, many eliminators already include provision for critical control of screening-grid voltage, and so no special precautions are necessary.

THE adjusting screw of a trimming condenser (built into a ganged tuning condenser) is invariably in electrical connection with the "earthy" side of the circuit, and, in consequence, there should be, theoretically, no risk of disturbing tuning by body-capacity effects while these trimmers are being adjusted.

A Trimming Tool

But occasionally it will be found that, in order to make the adjustment, the metal shank of a screw-driver may come into sufficiently close proximity with high-potential connections or components to introduce a change in the tuning of the associated circuits. In this way misleading effects may be encountered, and it is not a bad plan to make a special trimming tool. This device is nothing more than a screw-driver with the shortest possible metal blade, and a fairly long handle of insulating material—wood is quite good enough for this purpose.

As trimmer adjusting screws generally turn quite freely, it may be quite permissible to avoid the use of metal altogether, and to make a special screw-driver with some such insulating material as a strip or rod of bakelite, paxolin, or ebonite.



A simple form of insulated screwdriver, for adjusting trimming condensers. It is supplied with certain H.M.V. radio-gramophones.

When dealing with circuits where adjustments are exceptionally critical, it is perhaps worth while to take some pains to see that the screw-driver blade shall be an exact fit in the slot of the adjust-

ing screw. If this is done all backlash is avoided, and it will be found that adjustments can be made more accurately, and certainly much more easily, than when the width of the slot is considerably greater than the width of the blade. This is a point worth while remembering when making initial adjustments to the Station Finder.

THERE must be many sets using manufactured coils of the standard type (tuning coil, with tapping or separate primary winding for aerial, and also a reaction winding) as the tuned-anode coil of an H.F. valve, reaction being applied from the detector anode circuit.

A Simple Selectivity Device

Here, ready to hand, is a means of increasing selectivity with these coils. Instead of using the whole coil in the anode circuit, connect

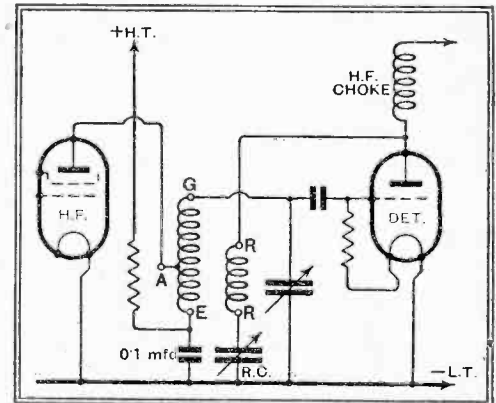

Fig. 1.—By joining the preceding anode to the "aerial" terminal of a standard coil, selectivity is improved.

the anode of the H.F. valve to the terminal marked "Aerial" of the coil (as in Fig. 1). The method thus applied is identical to that universally used to obtain selectivity between the aerial and input tuning circuit. The result will be an enormous increase in selectivity, accompanied by a relatively small drop in signal strength.

What happens is briefly this: The anode circuit impedance is reduced considerably, giving a lessened oscillatory p.d. across its portion of the coil. The tuned circuit is more or less loosely coupled to this coil. The fact of loose coupling has, however, reduced the damping effect of the preceding valve in proportion to the turns ratio. Thus the reduction in applied volts is to some extent compensated for by an increase in current, since current in a resonant circuit depends on the damping present. On the other hand, selectivity is gained, both due to the reduction in damping of the tuned circuit and to the loose coupling.

Q.P.P. with Triodes

Further Battery-economy Circuits

NOW that the great benefits conferred by quiescent push-pull are becoming appreciated, there must be many constructors who contemplate building a Q.P.P. receiver, or who propose to modify the output stage of their existing battery set. The desire to share with the mains user the undoubted advantages of a moving-coil loud speaker is natural enough, as is also the demand for more and more undistorted energy from the output stage.

True, the valve manufacturers not long ago gave us an excellent series of two-volt power valves capable of handling a few hundred milliwatts, but until the advent of Q.P.P., a wide gulf has separated mains output from that given by the battery set.

Q.P.P. and Mains Sets

Many queries have arisen as a result of the publication in this journal of the theory¹ and practice² of pentodes in Q.P.P., and it is proposed to deal with a few of them. First, it is asked whether automatic grid bias can be arranged; the answer is in the negative, because a fixed bias point for each valve is essential, and as the mean anode current during modulation varies within wide limits, large changes in grid potential would take place. Can Q.P.P. output be included in a set with which an H.T. eliminator is used? The answer must be in most cases "No," because the H.T. volts delivered by the eliminator vary in sympathy with the current taken, and a steady anode voltage—a desirable condition—would be

By
W. I. G. PAGE, B.Sc.

denied to the valves. In eliminators where the regulation is especially good it would be worth a trial.

Can Q.P.P. find application in a mains set? The answer to this is governed by the answers to the two previous questions. It would be possible only with battery bias or with a small separate rectifier for grid potential and an H.T. supply system such as a mercury rectifier, with which regulation can be beyond reproach. There are two other important questions, but happily the answers are less gloomy. Can matching of valves in Q.P.P. be dispensed with? Are triodes in Q.P.P. satisfactory? The rest of the article will be devoted to discussing these problems.

Considerable research has been carried out by the General Electric Co. into the possibility of using triodes in Q.P.P., and the writer is indebted to this company for certain data in respect of these valves which is given later. Any Q.P.P. system benefits if matched valves are employed, and the circuit of the "Quiescent Push-pull Two" receiver recently described probably represents the most efficient arrangement, but unless the very utmost

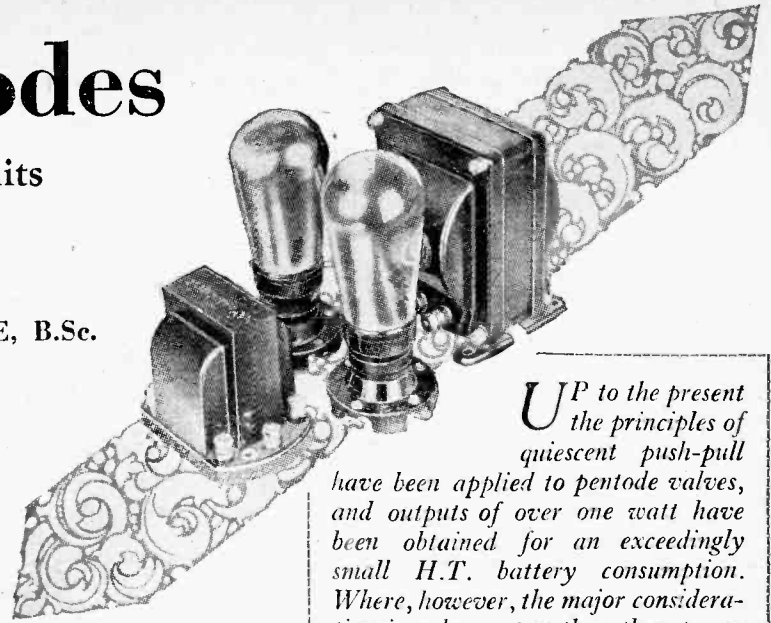

UP to the present the principles of quiescent push-pull have been applied to pentode valves, and outputs of over one watt have been obtained for an exceedingly small H.T. battery consumption. Where, however, the major consideration is valve cost rather than power output, triodes in Q.P.P. will probably find wide application, especially as matching is not essential and moving-iron speakers can be used satisfactorily.

is to be squeezed out of each valve, liberties can be taken. In fact, it is found that with triodes and the smaller pentodes, valves bought at random and representing the extremes of manufacturing tolerances may be pressed into service with the knowledge that the results will be entirely satisfactory, and a milliammeter, although most helpful, is not essential.

Experiments with Two Receivers

Two receivers have been constructed, one with two Osram L.P.2 valves in Q.P.P., and the other with two P.2 valves. From the results obtained it can be stated with confidence that the volume and quality of reproduction will satisfy the most critical. Unmatched triodes are essentially for use where the major consideration of valve cost outweighs power output. In a room measuring, say, 15ft. by 15ft., a watt of speech energy is unnecessary, and 350 to 400 milliwatts provides good entertainment. The two L.P.2 valves at 150 volts H.T. will give this output for the ridiculously small consumption of 1 mA. standing current per valve. The detector will feed the output stage without an intermediate valve, use being made of one of the high-ratio intervalve transformers developed for Q.P.P. Although the best results will be obtained with a moving-coil speaker, the use of a moving-iron instrument is not ruled out.

The load per valve is 5,000 ohms, so that the output transformer ratio is almost the same as that for two Pen.220A valves, for which so many speakers and output devices are already available. There is a very slight tendency for high notes to be accentuated, but this is cured by the ordinary compensator circuit consisting of an 0.005 mfd. condenser and a 20,000-ohm resistance in series, the whole being shunted across the output transformer

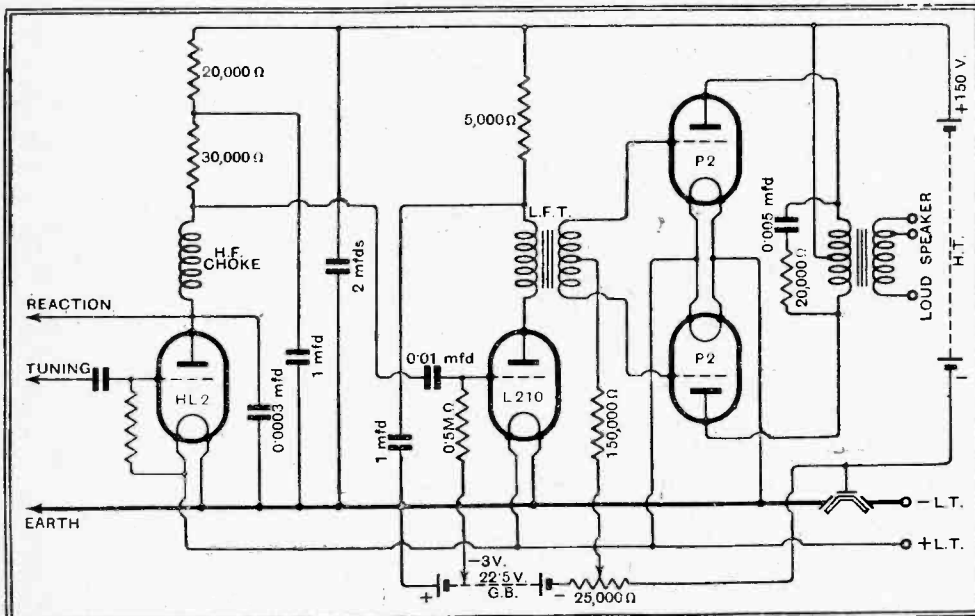

Fig. 1.—The detector-L.F. portion of a receiver with two P2 valves in Q.P.P. In this case an intermediate L.F. stage is necessary and the intervalve transformer ratio should be about 4 or 5 to 1.

Q.P.P. with Triodes—

primary. The 150,000-ohm anti-parasitic resistance in the common bias lead must be retained and a potentiometer across the

details of the set will be unnecessary, but emphasis should be laid on the tremendous saving in H.T. current effected by the Q.P.P. stage. It would require over 40

TABLE A.
QUIESCENT PUSH-PULL DATA.

| Milliwatts Output. | Two Valves in Q.P.P. (For Type see Table B.) | H.T. Volts. | Bias. | Total Quiescent H.T. Current* (mA.) | Total Working H.T. Current* (mA.) | Output Transformer (or Choke) Step-down Ratio for Speaker of following Impedance (Ohms) :— | | | | | |
|--------------------|--|-------------|-------|-------------------------------------|-----------------------------------|--|-----|----|----|----|-------|
| | | | | | | 2 | 3 | 5 | 10 | 15 | 2,000 |
| 200 | T1 | 110 | 6 | 2.0 | 3.5 | 100 | 82 | 64 | 44 | 36 | 3.0 |
| 300 | T1 | 130 | 7½ | 2.0 | 3.5 | 100 | 82 | 64 | 44 | 36 | 3.0 |
| 400 | T1 | 150 | 9 | 2.0 | 4.0 | 100 | 82 | 64 | 44 | 36 | 3.0 |
| 500 | T2 | 120 | 18 | 3.0 | 5.0 | 70 | 58 | 45 | 32 | 26 | 2.5 |
| 800 | P1 | 110 | 6 | 3.0 | 5.5 | 100 | 100 | 80 | 56 | 46 | 4.0 |
| | T2 | 150 | 21 | 4.0 | 7.0 | 70 | 58 | 45 | 32 | 26 | 2.5 |
| 1,000 | P1 | 130 | 7½ | 3.5 | 6.0 | 100 | 92 | 72 | 54 | 42 | 3.6 |
| | P1 | 150 | 9 | 4.5 | 7.5 | 100 | 90 | 70 | 49 | 40 | 3.5 |
| 1,300 | P2 | 110 | 13½ | 4.0 | 6.0 | 95 | 77 | 60 | 42 | 35 | 3.0 |
| | P2 | 120 | 15 | 4.5 | 6.5 | 95 | 77 | 60 | 42 | 35 | 3.0 |
| 2,000 | P2 | 150 | 21 | 5.0 | 8.0 | 92 | 75 | 58 | 41 | 34 | 2.9 |

* Includes total auxiliary grid current in the case of pentodes. The column for the 2,000 ohms speaker impedance refers to a moving-iron instrument of that value or to a moving-coil speaker with a built-in matching transformer giving the same value.

grid battery (9 to 10½ volts in this case) is a refinement which is well worth while.

In all cases where a meter is not embodied in the set it is as well to move the bias potentiometer slider to a position of over-bias, thus giving serious distortion, and then to reduce the negative grid potential slowly until distortion on loud passages is absent. This will automatically give the correct quiescent or standing current, and the valves will be working under optimum conditions. It will be unnecessary in the circumstances to have an H.T. battery tapped at intervals of 1½ volts at the positive end.

The circuit diagram showing the detector-L.F. portion of the set with two unmatched Osram P.2 valves (triodes) in Q.P.P. is given in Fig. 1, and as the grid swing of the output system in this case is about 21 volts the detector must be followed by an intermediate low-gain resistance-coupled stage. Fortunately, this is an economical addition, incurring about 11s. in cost of materials and augmenting the anode current by only 1 mA. The output from the set amounts to about 800 milliwatts, which represents ample volume for a room measuring about 14ft. by 25ft., and again the quality of reproduction is very pleasing.

As all values are given in Fig. 1, further

TABLE B.
KEY TO VALVE TYPES.

| T.1. | | | |
|-------------------|----|----|--------------|
| Cossor | .. | .. | .. 220 PA |
| Osram and Marconi | .. | .. | .. LP2 |
| Mazda | .. | .. | .. P.220 |
| Mullard | .. | .. | .. PM2A |
| T.2. | | | |
| Osram and Marconi | .. | .. | .. P2 |
| Mazda | .. | .. | .. P.220A |
| Mullard | .. | .. | .. PM.202 |
| P.1. | | | |
| Cossor | .. | .. | .. 220 HPT |
| Osram and Marconi | .. | .. | .. PT2 |
| Mazda | .. | .. | .. Pen. 220 |
| Mullard | .. | .. | .. PM22A |
| P.2. | | | |
| Cossor | .. | .. | .. 220 PT |
| Mazda | .. | .. | .. Pen. 220A |
| Mullard | .. | .. | .. PM22 |

mA. from the H.T. source if two P.2 valves were used in ordinary push-pull to give the same output. Actually, in the set under discussion, the standard current per valve is 2 mA, and the working current—which is the deciding factor in choosing the capacity of the H.T. battery—only 7 mA. total for the two valves.

To facilitate the choice of a suitable valve for a given output, Table A has been

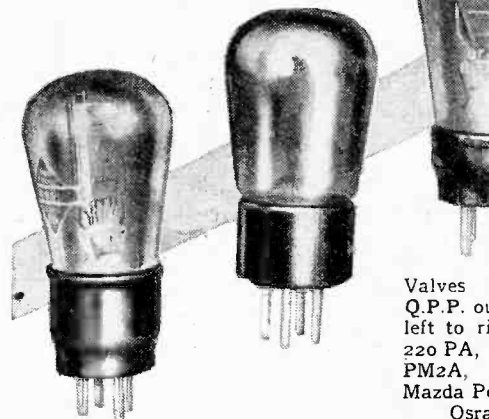

Valves suitable for Q.P.P. output. From left to right: Cossor 220 PA, Mullard PM2A, Osram P2, Mazda Pen. 220A and Osram PT2.

compiled, which includes the majority of British battery valves which can satisfactorily be used in Q.P.P. T1 and T2 represent triodes and P1 and P2 pentodes, the key to the types of different makes being given in Table B.

The H.T. battery should have an initial potential of about 10 volts higher than the figure given in the third column, so that it will settle down after short use to the required value. If the bias necessary (4th column) is above about 15 an intermediate R.C.C. stage will be required before the output valves, and it can well conform to the circuit of Fig. 1. The total quiescent current is given in the next column, and includes in the case of pentodes the two auxiliary grid currents. It is interesting to note that the average working current seldom reaches twice the value of the quiescent current, although peak currents on deep modulation may reach five times this value.

The reader may be somewhat surprised at the low average H.T. consumption, but when it is realised that appreciable current is taken only when a signal is being received, the reason will be clearer, especially if the composition of a typical five-hour broadcast programme be examined. The following is part of a continuous evening's programme during which Q.P.P. current measurements were made.³ Speech and intervals account for 125 minutes, during which little current is used.

| | Minutes. |
|----------------------------------|----------|
| News and Talks | 80 |
| Pianoforte | 20 |
| Talks with musical illustrations | 30 |
| Orchestral concert | 95 |
| Dance music | 60 |
| Intervals | 15 |

300=5 hours

The remaining columns of Table A are devoted to the step-down ratio which must be used in the output transformer with speakers of different impedance. With 2-ohm speech coils, which are popular

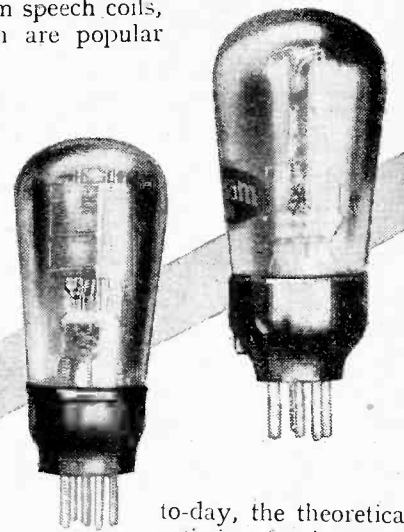

to-day, the theoretical ratio in a few instances is more than 100 to 1, but as such transformers are not made no ratio exceeding this value is shown. To exemplify the use of the tables, let us suppose that an output of 400 milliwatts is required from a moving-coil loud speaker of 10-ohms

impedance (we will assume that the built-in transformer—if the speaker has one—is disconnected). A valve of Class T1 would be chosen, the H.T. voltage must be initially about 160, the bias 9 volts, and no intermediate L.F. stage is necessary. The transformer ratio should be 44 to 1—the nearest standard ratio of 42 to 1 being quite satisfactory. With a moving-iron speaker of high resistance (say 2,000 ohms) the ratio would have to be 3 to 1.

Fortunately the ear does not notice slight mismatching of the output stage, and where ratios between, say, 68 or 82 to 1 are indicated, a transformer of 75 to 1 would be perfectly satisfactory. Many output devices with ratios between 1 to 1 and 100 to 1 were reviewed in an article entitled "More About the Quiescent Push-pull Two," and there should be little difficulty in selecting suitable components.

³ Data supplied by the General Electric Co., Ltd.

NEWS of the WEEK

Bravo, Barrow!

IN response to complaints the Barrow (Leicester) Rural Council is equipping the local pumping station with apparatus to prevent interference with radio reception.

How the Money Goes

POST Office accounts for 1931-32 show that cash receipts from wireless licences amounted to £2,295,060, of which £1,225,709 was paid to the B.B.C.

Bredow off to Spain

SPAIN now has the opportunity to become one of the leading European nations in broadcasting affairs. We learn that Dr. Hans Bredow, the founder and late Commissioner of German broadcasting, is proceeding to Spain to reorganise the broadcasting service.

Better German Broadcasting

THAT German broadcasting has taken an encouraging turn towards greater prosperity is indicated by the licence figures just published, which show that the number of listeners increased by 120,000 during January. It is believed that the broadcasting of political speeches and improved programmes are the responsible factors.

At the moment German broadcasting is under the control of the Secretary of State, the Commissioners both having resigned.

Sir Robert Donald

SIR ROBERT DONALD, who died last week at the age of seventy-two, will be remembered for his work in connection with the Imperial Wireless Telegraphy Committee of 1924, of which he was chairman. He was a keen advocate of Empire broadcasting.

America in Berlin

EMBOLDENED by reports in *The Wireless World* of good reception of American stations in London, a Berlin correspondent carried out nocturnal tests with interesting results. "Tests were carried out on two consecutive nights," he writes, "reception being good from 2 to 3 a.m., C.E.T. A superhet was no good as it had no high-frequency amplification ahead of the first detector. A straight H.F.-det.-L.F. did the trick, using reaction. Static was pretty bad, but I roped in three stations at good strength and many more which were unintelligible. I live in the centre of the town, and on the second floor of a five-story building. I was using a small indoor aerial.

Stabilising H.F. Amplifiers

THREE research workers, Mr. W. Ure, B.Sc., Mr. E. J. Grainger, M.Sc., and Mr. H. R. Cantelo, M.Sc., are responsible for a paper to be read before the Wireless Section of the Institution of Electrical Engineers on Wednesday next, March 1st. The paper will deal with "the Balancing and Stabilising of High Frequency Amplifiers, with special reference to Power Amplifiers for Radio Transmitters."

Current Events in Brief Review

Congratulating the President

AMONG the first congratulatory messages destined to be received by Franklin D. Roosevelt after his inauguration as President on March 4th will be despatches transmitted via amateur radio from the Governors of the forty-eight States and the territorial possessions. Arrangements now being worked out by the American Radio Relay League, in cooperation with the Washington

New U.S. Network?

PLANS for a new American broadcast network, to supplement those of the National Broadcasting Company and the Columbia System are stated to have reached an advanced stage. According to our Washington correspondent the organiser of the new undertaking is Mr. Ed. Wynn, who skyrocketed to radio fame as a radio-impressario with the Amalgamated Broadcasting System, Inc., of New York, formed to pro-

CAR RADIO ON THE CONTINENT.

The new Telefunken car set displayed at the Berlin International Automobile Show is a 6-valve superhet accommodated under the driver's seat and controlled from the dashboard. The loud speaker is housed in a canvas cover in the rear compartment.



vide a new range of programme material for the existing networks.

Certain "Detroit millionaires," stated to be at the back of the enterprise, are described as being "very close to the Ford Motor Co., Burroughs Adding Machine Co., Briggs Body Co., Kelvinator Co., and Frederick Stearns Co., all of whom have expressed themselves as being ready to go on the air when the network functions properly."

Since the formation of NBC in 1926 and of CBS the following year, a number of attempts have been made to create new networks, but all of them either failed to develop or faded from the picture after getting started because they were unable to stand the financial strain or meet competition. Various small regional chains have been created.

Successful Television

HOW to obtain successful reception of television images will be the main theme of a lecture entitled "Some Aspects of Television Reception," to be delivered before the Television Society by Mr. T. H. Bridgewater, Grad. I.E.E., at University College, Gower Street, London, W.C.1, at 7.0 p.m. on Wednesday, March 8th. Cards of invitation can be obtained on application to Mr. J. J. Denton, A.M.I.E.E., 25, Lisburne Road, Hampstead, N.W.3.

A Simple Request

SMALL BOY: Father says please can you lend us your wireless set this evening?

Neighbour: With pleasure! Are you giving a party?

S.B.: No, we want to sleep.

Radio Service on Wheels

MESSRS. E. K. COLE, LTD., the radio manufacturers, have organised a body of specially trained engineers, provided with fully equipped motor cars, who will tour the country so that owners of EKCO instruments can command service at a moment's notice. A postcard to the makers, a few formalities, and an expert is on the set owner's doorstep.

Each engineers' squad, who will travel in a green and gold car, is provided with enough spare parts to make a number of complete wireless sets.

Choosing an Announcer

THREE hundred applicants—five of them women—competed for the post of announcer at Radio-Vitus, Paris. Among those applying was a winner of the French Prix de Rome (architecture), several doctors of laws, and more than one licentiate of literature. No fewer than 270 competitors were eliminated in the "first round." A third test whittled down the remainder to a dozen, from which a special jury will choose six to stand public examination at the microphone.

The final decision is to be arrived at by listeners' vote.

The Four Millionth

MISS GRACIE FIELDS received telegrams of congratulation from all corners of the globe on Tuesday of last week, when the celebrated comedienne personally pressed her four millionth record at the "His Master's Voice" factories, Hayes, Middlesex. The production of Gracie Fields' records alone has given employment to over 120 people for 4½ years.

If the recording track of her voice were unfolded it would reach over 800,000 miles, and statisticians further declare that, if all the records were played consecutively, it would take twenty-eight years.

Luxembourg

NEWs concerning the Luxembourg 200-kilowatt station is remarkably sparse, but, if reports via America are to be believed, the new transmitter will soon produce a real "shake-up" in the European ether.

"A typical bit of America," enthuses a Washington writer, "will be transplanted to the Old World when this first 'international radio station' soon begins operation."

A report just received by the U.S. Department of Commerce from its Attaché at the Hague states that "commercial interests under the auspices of a Franco-German combine, plan to use the station from 8 a.m. to 2 p.m. daily as an advertising outlet, operating on the long wave length of 252 kilocycles.

Mutual Induction

The Theory of Coil Coupling Explained

By S. O. PEARSON, B.Sc., A.M.I.E.E.

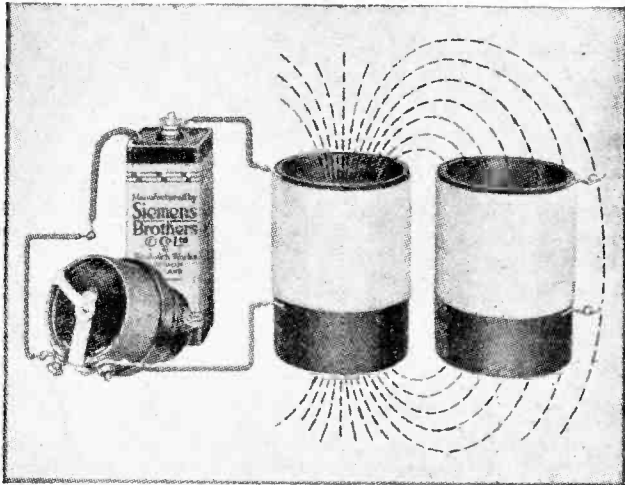

WITHOUT a knowledge of the fundamental principles of mutual induction it is difficult to understand the theory of coil coupling. Mutual induction can be defined as that electro-magnetic property of two circuits (or two parts of a single circuit) by virtue of which a changing current in one causes an electromotive force to be induced in the other.

former with the wires wound on side by side, but even in this case the coefficient of coupling is less than unity. The coefficient of coupling would be unity, or 100 per cent., if the whole of the magnetic flux produced by a current in one of the windings were completely linked with both windings, a condition which cannot be fully realised in practice, even when the coils are wound on an iron core.

Transformer Principle Based on Mutual Induction

The A.C. transformer represents the commonest example of the practical use of mutual induction. A transformer consists essentially of two coils magnetically coupled together, their relative positions being fixed. In the case of low-frequency and power transformers, the primary and secondary windings are wound on a common iron core, so that the coefficient of coupling approaches 100 per cent., but for H.F. transformers the windings are usually carried on a non-magnetic former and are said to be "air-cored."

When an alternating current is sent through the primary winding of a transformer it sets up an alternating magnetic flux which, acting on the secondary winding, generates an alternating E.M.F.

MUTUAL induction is an electro-magnetic property of two circuits so situated with respect to each other that a current in one sets up a magnetic field which is linked with both, that is to say, a property of two circuits which are magnetically coupled together. It is a fundamental principle that when the magnetic flux linked with a circuit is changing, an electromotive force is induced in the circuit, its magnitude being proportional to the rate of change. When the magnetic flux linked with a circuit is produced by a current in the circuit itself, then, if the current is varied, the flux will vary also and an E.M.F. is induced in the circuit proportional to the rate of change of current. This property of a single circuit is called self-induction. If, however, there are two circuits magnetically coupled together, as explained above, a variation of current in the one will cause a variation of the magnetic flux threading through the turns of the other and an E.M.F. proportional to the rate of change of current in the first will cause an E.M.F. to be generated in the other. This property is referred to as mutual induction.

A Definition

The first circuit, in which the current is varied, is called the *primary*, and the second, in which the induced E.M.F. is considered, is called the *secondary* circuit. As in the case of self-induction, the practical unit in which mutual induction is expressed numerically is the *henry*. The mutual inductance, or coefficient of mutual induction, between two circuits is said to be one henry if one volt is induced in the secondary circuit when the current in the primary is changing at the rate of one ampere per second. The mutual inductance in henrys is usually denoted by the symbol M and the induced E.M.F. in volts in one circuit is equal to the product of M and the rate of change of current in amperes per second in the other. The mutual inductance M is the same which-

ever of the two circuits is taken as the primary.

Degree of Coupling

As an example, consider two coils whose self-inductances are L_1 and L_2 henrys respectively placed in close proximity to each other as shown in Fig. 1. When a current is passed through L_1 a magnetic field is established and some of the magnetic loops are linked with the second coil L_2 . Let M be the mutual inductance in henrys between the coils. Now if the current in L_1 is varied by changing the value of the resistance R , the flux linked with L_2 will be varied in proportion, and an E.M.F. will be induced in L_2 ; the value of this secondary induced E.M.F. is equal to $M \times$ (rate of change of primary current). The degree of magnetic coupling obviously depends on the proximity and relative positions of the two coils and is expressed numerically as the ratio of the mutual inductance to the square root of the product of the individual self-inductances. This is called the *coefficient of coupling*, and is given by $k = \frac{M}{\sqrt{L_1 L_2}}$, a number

which cannot exceed unity, and which in practice never reaches unity. Coils are said to be tightly coupled when they are brought close together to give a relatively high value of M and k , and vice versa. The tightest coupling is obtained when the two coils are wound on the same

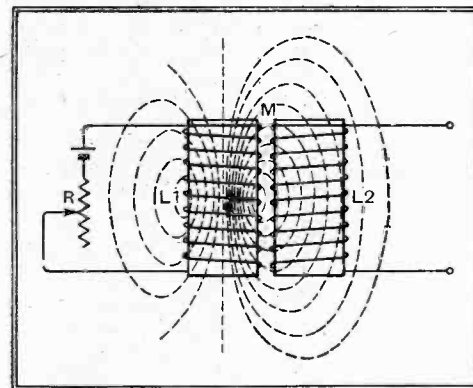

Fig. 1.—Magnetically coupled coils.

coil of inductance L henrys, the induced or back E.M.F. set up is equal to the product of this current and the reactance of the coil, namely, $I \times 2\pi f L$ volts, where f is the frequency and $\pi = 3.1416$. In the same way, if M is the mutual inductance in henrys between the two windings and I_1 is the primary current, the induced E.M.F. in the secondary winding, with the latter on open circuit, is $I_1 \times 2\pi f M$ volts.

In the case of an iron-cored transformer, where practically every line or loop of magnetic flux is completely linked with every turn of both windings, it is obvious

Mutual Induction—

that, when the flux is alternating, the same E.M.F. will be generated in each and every turn of both windings, and from this it follows that the total E.M.F. in each winding will be directly proportional to the number of turns comprising each. So if N_1 and N_2 are the numbers of turns in the primary and secondary windings respectively, and if a voltage E_1 is applied to the ends of the primary winding, the secondary voltage is given by the simple relationship

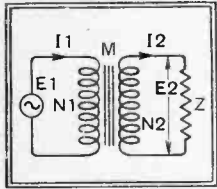

$$E_2 = E_1 \times \frac{N_2}{N_1}$$

Secondary Winding Loaded

When a load impedance Z of some form is connected across the secondary terminals of a transformer, as in Fig. 2, a current flows in the secondary winding, and this in turn reacts back on to the primary winding

through the medium of the mutual induction. And so the current taken by the primary winding will depend, not only on the impedance of the primary winding itself, but also on the amount of current flowing in the secondary, although there is no direct electrical connection between the windings. The extra current taken by the primary winding of a transformer when a current is allowed to flow in the secondary is exactly proportional to the secondary current, and these two currents have equal and opposite magnetic effects on the core, the extra primary ampere-turns just opposing the secondary ampere-turns, so that, apart from the initial magnetising current, $I_1 N_1 = I_2 N_2$, or $I_1 = I_2 \frac{N_2}{N_1}$. This is just the reverse compared

with the relationship for the E.M.F.s. So a transformer which steps the voltage up in a given ratio will step the current down in the same ratio, and vice versa. Consequently, the product of primary amps and volts is approximately equal to the product of secondary amps and volts for an ordinary iron-cored transformer, but

these conditions do not hold for H.F. transformers where the coupling coefficient is considerably less than unity.

BOOKS RECEIVED

The Principles of Electromagnetism, by G. B. Moullin.—A text-book for advanced students, comprising the elements of magnetism, the second law of Electrodynamics. Iron in a magnetic field. Equations and Special Problems. Pp. 279 + viii, with 152 diagrams and illustrations. Published by the Oxford University Press, London. Price 17s. 6d.

Casque's Sketch Book, by S. C. H. Davis, the well-known racing motorist, who gives us in a collection of drawings an idea of racing as it might be and as, so often, it really is. Pp. 60. Published by Iliffe and Sons Ltd. Price 2s.

A Technical Description of Broadcasting House. Outlining some of the problems encountered in the design and construction of the building and the plant installed therein, with a general account and description of the architectural features, the acoustic treatment of the studios, power supply, studio and control room equipment, etc. Pp. 105 + xii, with 72 illustrations, plans, and diagrams, and five plates. Published by the British Broadcasting Corporation. Price 5s.

ON THE SPOT

VISITS TO FOREIGN BROADCAST STATIONS

VI.—Radio Berlin No. 1 (Witzleben), 716 kc., 419 m., 1.5kW.

ALL Europe has heard of the great "Haus des Rundfunks" in Berlin. No fewer than three broadcasting organisations have their offices here, and two have studios. There is the Reichs-Rundfunk-Gesellschaft, which holds shares in all the other German regional companies, except the Bavarian; there is also the Funk-Stunde A-G. Berlin, controlling the local broadcasting, and the



An unusual view of the short wave aerial at Königswusterhausen.

Deutschlandsender Company, responsible for the educational transmissions of Königswusterhausen.

My theme is the Funk-Stunde, which operates Radio Berlin (Witzleben). The programmes to some extent reflect the trend of the times; economy is the watchword, for since April last two hundred thousand fewer listeners have paid licence fees. Even the cost of an O.B. line is a consideration, but the programme director continues very creditably with the limited resources at his disposal,

It is half an hour's journey on the underground from the centre of the city to Berlin's "Broadcasting House." The Witzleben transmitter is quite near to the studio, standing in the grounds of the radio exhibition. Strangely enough, although the Funk-Stunde is really a local concern, serving only the Berlin area, the organisation savours much more of red tape than does the Reichs Rundfunk-Gesellschaft, covering almost the whole of Germany! Until recently Funk-Stunde lacked the personal note, but happily the new director of programmes, although a busy man, can always spare the time to see an interested visitor.

The personal touch means much in broadcasting; in fact, it can in large measure atone for lack of funds. Under the new régime Berlin looks for an enlarged clientele in the near future.

WANDERING WAVE.

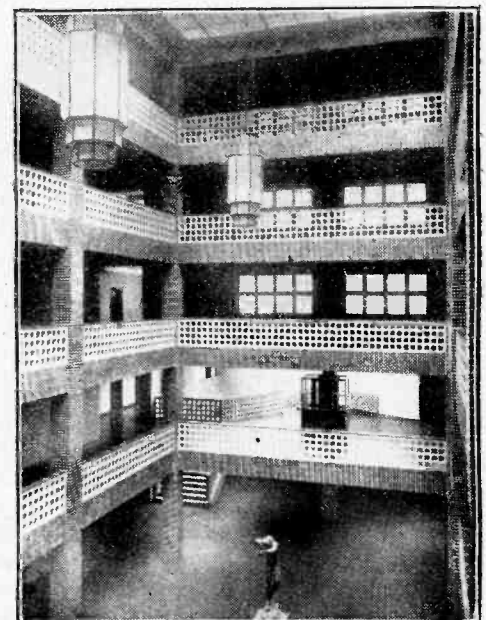

Part of the entrance hall of Berlin's "Broadcasting House."

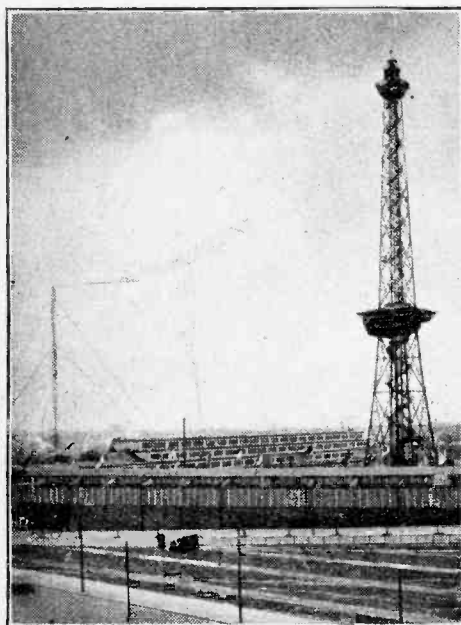

Photo by courtesy of R.R.G., Berlin
The Witzleben aerial, supported at one end by the famous Radio Tower.

New Automatic Bias Scheme

Self-bias for the Battery Variable-mu Valve

By E. G. BOWEN, M.Sc.

IT has now become usual to provide automatic bias for battery sets, and, as a natural corollary, controllable bias for a variable-mu H.F. stage is obtained in the same way. A method which has been described several times in this journal is illustrated in Fig. 1. A potentiometer is shunted across the main bias resistor and the H.F. grid circuit is returned to the slider of this potentiometer. In this way any desired proportion of the total bias voltage provided may be applied for purposes of controlling sensitivity.

This arrangement works satisfactorily in practice, but is open to criticism on the grounds that the H.F. valve may require a higher bias than the output valve, and that as the bias of the variable-mu is changed, so also is the total anode current. This has the effect of changing slightly the bias voltage on the output valve, which should, of course, remain constant.

By a simple rearrangement of the biasing resistances the deficiencies of the original circuit may be eliminated. The modified circuit is shown in Fig. 2, and the resistances have been chosen for a typical three-valve receiver.

Now, when maximum bias is applied to the variable-mu valve, the potentiometer slider is at A, the total anode current is, say, 9 mA., and the biasing resistance in circuit just 666 ohms (the fixed resistance of 2,000 ohms being shorted out)—giving a negative bias of $\frac{9 \times 666}{1,000} = 6$ volts on both output and high-frequency valves. When zero bias is applied to the first valve the potentiometer slider is at B, the total anode

range 0 to 6 volts, as shown graphically in Fig. 2.

A variable resistance of 666 ohms is not a standard product, but any two resistances, one fixed and one variable, when arranged in parallel and equivalent to a single variable resistance of 666 ohms will do. The final circuit is shown in Fig. 3.

THERE is a definite tendency among constructors of battery sets to follow mains practice and provide automatic bias for both H.F. and L.F. valves. A new bias scheme is described in this article which overcomes the difficulties hitherto associated with battery variable-mu valves.

It is quite simple and cheap to construct and has very definite advantages over that of Fig. 1.

With the improvement in the efficiency of output valves there has been a gradual decrease in the amount of bias applied to them. A modern small pentode may need only from 3 to 4.5 volts negative bias so that cases will arise in which it is necessary to apply a greater bias to the high-frequency valve than to the output valve.

Consider a receiver whose total anode current may vary from 7 to 10 mA. and whose output valve requires a bias of -4 volts. If a maximum negative bias of 10 volts is required on the high-frequency valve the circuit shown in Fig. 4 may be used.

A potential of 10 volts must be maintained between A and B, so that when the slider of the potentiometer is at A maximum bias is applied to the variable-mu valve and the total anode current of 7 mA. flows. This requires a bias resistance of

$$\frac{10 \times 1,000}{7} = 1,430 \text{ ohms, which may conveniently be made up of a 2,000 ohm potentiometer AB with a resistance of 5,000 ohms in parallel. This, in turn, should be split into resistances of 2,000 and 3,000 ohms as shown, giving a tapping point from which the fixed bias of 4 volts negative is led off to the output valve.}$$

When the potentiometer slider is at B minimum bias is applied to the high-frequency valve, a total anode current of 10 mA. flows and the total biasing resistance is $\frac{1,430 \times 3,000}{1,430 + 3,000} = 993$ ohms, across which practically a full 10 volts is developed. The result is shown graphically in Fig. 4, and it will be seen that the bias on the high-frequency valve may be varied over a range of 10 volts, while the output valve receives a negative bias which remains practically constant at 4 volts.

This curve is perhaps the ideal for a battery receiver employing a variable-mu valve. The bias on the output valve remains fixed, and the bias on the first valve may be varied at will from zero to a negative potential greater than that applied to the output valve. Although no decoupling resistances and condensers are shown in the diagrams given above, in practice they should always be included to prevent un-

desired coupling between the stages. As far as possible the conditions chosen for these examples are those likely to be met with in practice. But the values of the resistances given above can easily be modified to suit practically any combination of valves in a battery receiver, even if two variable-mu types are used.

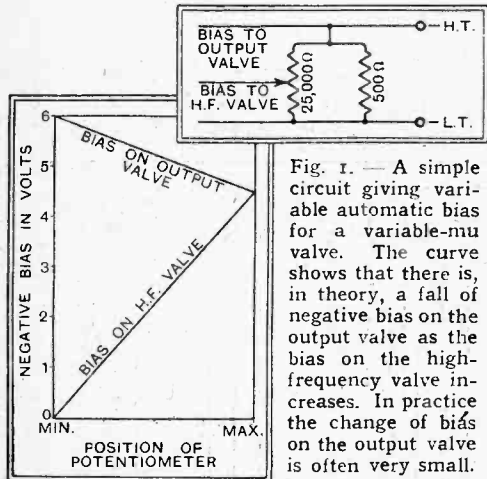

Fig. 1.—A simple circuit giving variable automatic bias for a variable-mu valve. The curve shows that there is, in theory, a fall of negative bias on the output valve as the bias on the high-frequency valve increases. In practice the change of bias on the output valve is often very small.

current is, say, 12 mA., and the bias resistance is $\frac{666 \times 2,000}{666 + 2,000} = 500$ ohms—giving

again a bias of $\frac{12 \times 500}{1,000} = 6$ volts on the

output valve. Using this circuit, the grid bias on the output valve remains constant at 6 volts, and the bias on the high-frequency valve may be varied over the full

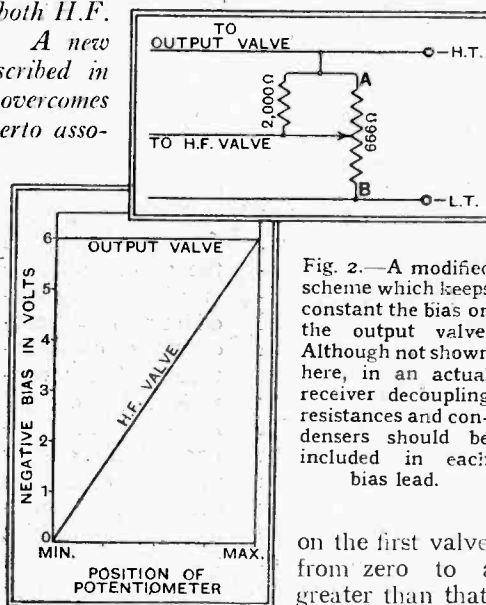

Fig. 2.—A modified scheme which keeps constant the bias on the output valve. Although not shown here, in an actual receiver decoupling resistances and condensers should be included in each bias lead.

on the first valve may be varied at will from zero to a negative potential greater than that applied to the output valve. Although no decoupling resistances and condensers are shown in the diagrams given above, in practice they should always be included to prevent un-

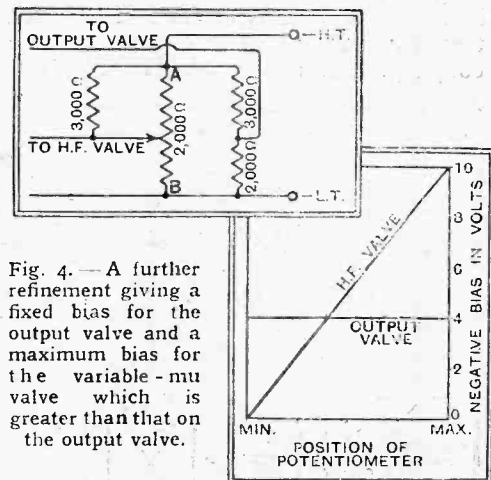

Fig. 4.—A further refinement giving a fixed bias for the output valve and a maximum bias for the variable-mu valve which is greater than that on the output valve.

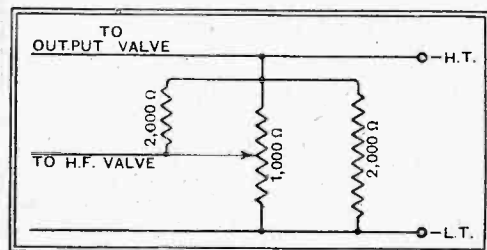
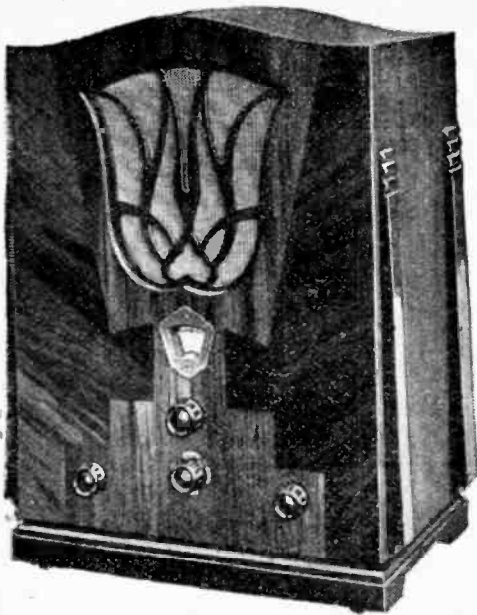

Fig. 3.—The final form of Fig. 2, using resistances of standard value.



Lotus

FOUR-VALVE A.C.

Receiver

An Inexpensive Set with Two H.F. Stages

IN the Lotus "2-H.F." model we have an example of a type of set which competes quite successfully with the more popular type of H.F.-det.-L.F. three-valve receiver. It is rather more ambitious, but includes only the three tuned circuits which have become almost standardised for general-purpose use. The cost of a receiver is largely determined by the number of these tuned circuits, and there are sound technical grounds for saying that by using two of them as intervalve couplings, rather than as elements of a band-pass filter, it is easy to obtain rather better selectivity and sensitivity without incurring much extra cost in other directions. The introduction of variable- μ valves has almost entirely removed the objections that were once urged against the simpler type of "2-H.F." receiver.

Starting at the input end of the Lotus set there is a special form of H.F. choke which is intended to prevent "break-through" of local medium-wave signals at the lower end of the long band. Double-wound transformers are used throughout for aerial-grid and intervalve coupling, and an external trimmer has

been fitted for the input circuit in order to compensate for variations in aerial capacity.

It is worth while noting that the two H.F. valves are of different types, that in the second position having a somewhat higher mutual conductance than the input valve.

The H.F. amplifier output is passed to another screen-grid valve acting as an anode-bend detector; this valve is self-biased by means of a cathode resistor, and a simple resistance-capacity filter is inserted next to its anode to dispose of H.F. energy in this circuit.

Coupling between the detector and the output pentode is effected by another resistance-capacity combination of fairly conventional design. Anti-reaction feedback of L.F. energy in this circuit is prevented by shunting the output bias resistor with a 50-mfd. dry electrolytic condenser.

In the anode circuit of the pentode there is the usual tone corrector, consisting of a resistance and condenser in series. But the resistance, instead of being fixed, is variable, and in this way a very simple but effective form of tone control has been provided. Although this refinement may

not be strictly necessary, it is certainly of great assistance in avoiding certain forms of interference; not only will it enable many heterodyne whistles to be avoided, but certain forms of electrical interference can be reduced in intensity by judicious operation of the control.

In the H.T. supply circuit another electrolytic condenser—this time of the "wet" type—is employed in conjunction with the loud speaker field for smoothing the output of a Westinghouse rectifier connected in a voltage-doubling circuit. Power

supply is quite generous; after allowing for the loss in energising the loud speaker field, some 240 volts are left for the valve anodes, screens, and the regulating potentiometer, which together consume about 60 milliamperes.

Due to the inclusion of the anti-break-through choke already mentioned, and also because precautions

are taken to prevent another form of break-through when a gramophone pick-up is employed, the switching system is necessarily somewhat complicated. Apart from having to perform these and the other usual functions, it controls a pair of indicating pilot lamps which illuminate the

FEATURES

General.—A self-contained four-valve receiver for A.C. mains supply and for operation with either external aerial-earth system or with an internal or mains aerial. Energised moving-coil loud speaker. Provision for gramophone pick-up.

Circuit.—Single-tuned input circuit, two H.F. stages, anode-bend S.G. detector, resistance-coupled to output pentode. Transformer feed to loud speaker. Westinghouse metal rectifier.

Controls.—(1) Ganged tuning. (2) Combined on-off, wave-range, and radio-gramophone switch. (3) Input volume control. (4) Tone control.

Price.—15 guineas complete.

Makers.—Lotus Radio, Limited, Lotus Works, Mill Lane, Liverpool.

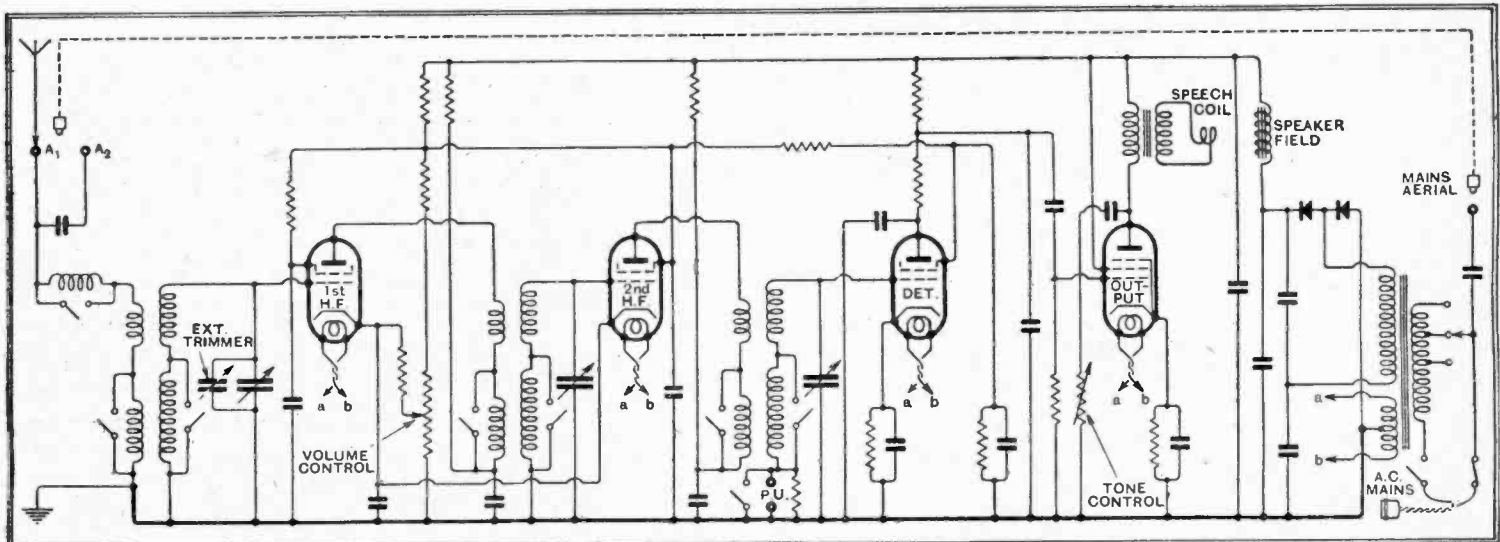

The complete circuit diagram. Internal and "mains" aerial connections are shown in dotted lines. All change-over switches are mechanically linked, and for gramophone reproduction the various circuits are automatically switched to different wavebands to prevent radio interference.

Lotus Receiver—

appropriate section of the wavelength-calibrated tuning dial. It is therefore reassuring to find that the switch mechanism is soundly designed, and, in spite of the multiplicity of contact points, it looks as

tuned circuits, it would be injudicious to make any attempt to extract the maximum possible amplification from each of the H.F. stages. As a result of an extended test, the conclusion is reached that a particularly happy compromise between con-

ment of the volume control knob.

During our tests, interference of the avoidable sort hardly ever gave trouble, and one could not reasonably expect better selectivity from any set at a comparable price. Where necessary, tuning

may be sharpened (but at the expense of signal strength) by making use of the "A2" aerial socket, but it was seldom that this adventitious aid to selectivity had to be brought into use.

The most striking fact about the quality of reproduction is the exceptional response towards the top end of the upper register. Brass instruments are reproduced with a degree of realism that, to say the least, is unusual. The behaviour of the set in this respect came rather as a surprise, as there is nothing in the general circuit arrangement that would lead one to anticipate an exceptional response in the upper register.

With regard to the lower and middle register, reproduction is also satisfactory; a bass resonance becomes audible at maximum volume, but disappears at "ordinary room" level; indeed, an attractive feature of the set is the pleasing and realistic quality that is obtainable at low volume—

under conditions where the average receiver begins to show a distinct falling-off. Generally speaking, there is a commendable absence of roughness and harmonic distortion.

The constructional booklet supplied with the set contains a complete circuit diagram containing a great deal of useful information; in this respect it is well ahead of the average publication of its class. All too often, essential technical information is lacking.

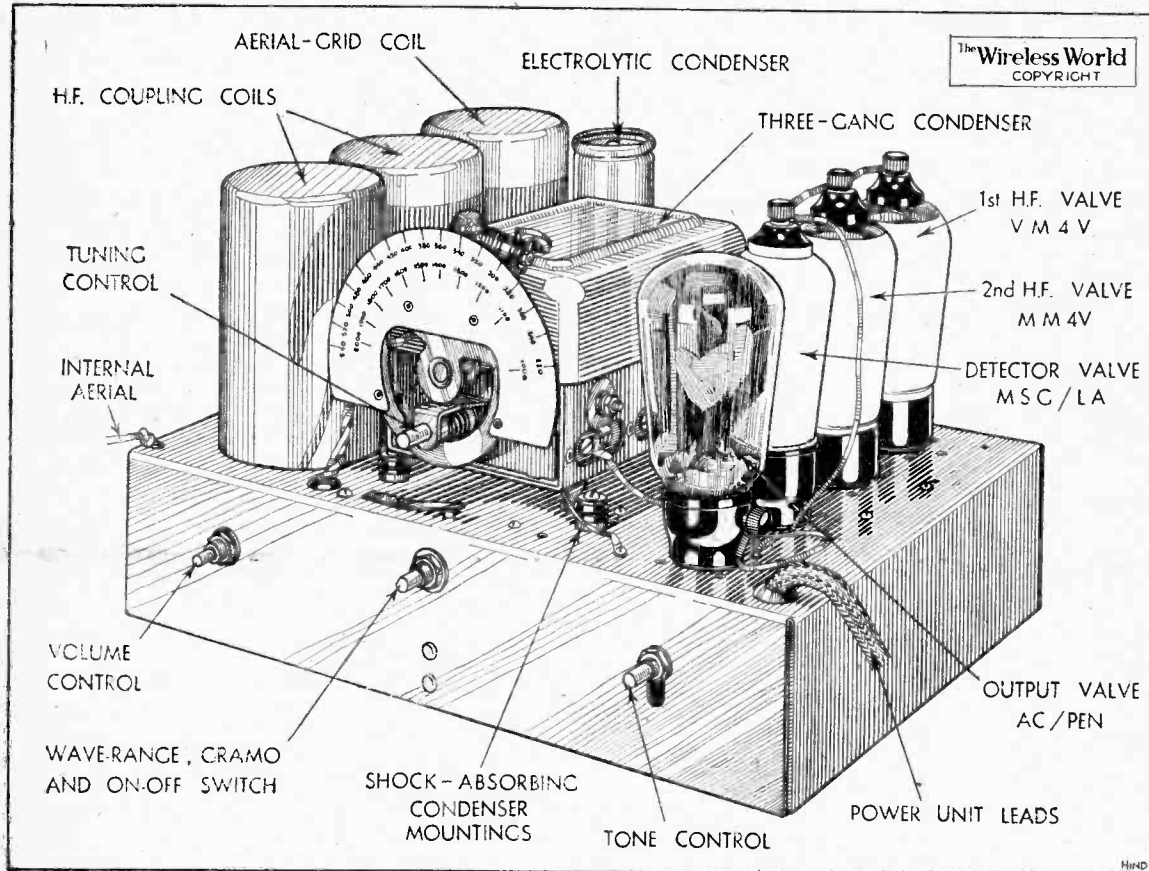

The receiver chassis, which is fitted in the cabinet on shock-absorbing rubber mountings.

if it were capable of standing up to its work indefinitely.

Constructionally, the Lotus set is interesting on account of the unusually extensive precautions taken to prevent the transmission of vibration from the loud speaker to other components. Not only is the loud speaker itself mounted by means of shock-absorbing rubber bushes, but the entire chassis is mechanically insulated from the cabinet in a similar way. Further, rubber insulation is provided for the ganged variable condenser.

The general arrangement of the set is somewhat unusual. To the backing board on which the loud speaker is mounted are secured all the components associated with the power supply equipment—transformer, rectifier, etc. Interconnection between this unit and the receiver proper is made by a multiple cable and an irreversible terminal strip. For purposes of test or repair, the two units may be divided up by removing screws, without the need for unsoldering connections. This is a good point, and should tend to facilitate testing and repairs. Similarly, the loud speaker and power unit are readily removable as a whole.

An internal aerial is provided in the form of a long lead, which, if desired, may be connected through a built-in condenser to the mains supply if it is found more satisfactory to use a "mains aerial."

In a set of this type, with a total of three

flicting requirements has been effected; although sensitivity could have been made greater, range is considerably better than that of the average H.F.-det.-L.F. three-valve set, and selectivity is also superior. This means that the set is definitely in the long-range class, and it proves itself capable of supplying a wide choice of programmes even when receiving conditions are not of the best.

In comparing a three-circuit "2-H.F." set with a 1-V-1 having the same number of circuits, one must not forget that the former yields its results in a comparatively effortless manner; the absence of a reaction control, which always needs more or less critical adjustment, is an important factor in favour of the Lotus set. Practically no skill or special ability is needed to obtain the utmost performance of which it is capable. Except for a slight tendency towards self-oscillation at maximum volume settings near the lower end of the longer waveband, the veriest beginner will encounter nothing that is likely to disturb or puzzle him. Even this tendency is easily checked by a slight adjust-

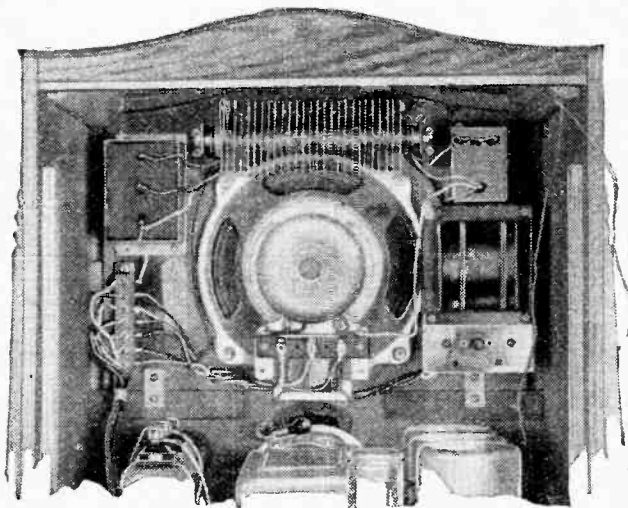

Loud speaker and power supply equipment are assembled on the baffle board, and may be removed *en bloc* as a unit.

LABORATORY TESTS

NEW ORMOND DRUM DRIVE

THE new condenser drive recently introduced by the Ormond Engineering Co., Ltd., Ormond House, Rosebery Avenue, London, E.C.1, is fitted with a drum of sufficient width to accommodate the names of stations on each side of the 0 to 180 division scale. The drum is 4in. in diameter, and carries a scale nearly 6in. long, so that ample space is available for logging the principal European broadcast stations.

The dial is exceptionally robust, and will drive a chain of condensers without the slightest trace of slip or backlash. These can be mounted on either side, thus permitting the dial to occupy a central position on the

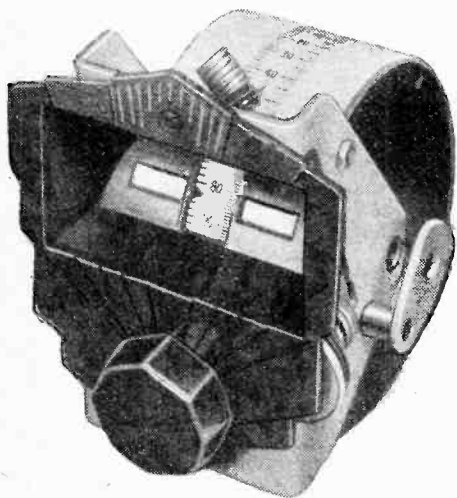

Ormond logging drum dial fitted with engraved scale and space for station names.

panel with the condensers conveniently placed and adjacent to their respective coils. It is driven through a reduction gear of 5.5 to 1 approximately, and is known as the Ormond Logging Drum Dial.

A cleanly moulded bakelite escutcheon plate is provided, also a lampholder for illuminating the scale, and the price is 7s. 6d.

SMITH'S ANODEX BATTERY

HAVING now completed our tests with the Smith's Anodex battery, mention of which was made in our issue dated December 9th last, we are able to reproduce here a most satisfactory performance curve. If we accept the arbitrary value of 60 volts as being the termination of the useful life of a 120-volt battery, then the Anodex model will provide some 375 working hours, or fifteen weeks of normal use.

It can be seen from the discharge curve that this does not coincide with the natural cut-off point which is quite well defined at the 500-hour mark. During the subsequent 125 hours the voltage is maintained at only a very slightly lower level than the theoretical end-point value. In view of the well-maintained output from the 200-hour mark to the natural

NEW RADIO PRODUCTS REVIEWED

end-point of the battery it might well be worth while to consider the purchase of a small boosting battery after the unit has been in use for about two months—a 60-volt size will suffice. With the help of this the H.T. supply could be maintained at a fairly constant value of about 100 volts for a further period of approximately four months at a very small extra cost.

Few batteries tested have maintained their voltage at such a high level for so long as this Anodex model, or exhibited such a long useful life, more especially as it does not fall in the expensive category, for the price of the 120-volt size is but 11s.

The makers are S. Smith and Sons (Motor Accessories), Ltd., Cricklewood Works, Cricklewood, London, N.W.2.

RECTIFIERS H.T. UNITS

AN H.T. battery eliminator, described as the "Q" 20 model, for use on A.C. mains, and giving a total output of 20 mA., is now obtainable from the makers, Rectifiers, Ltd., Brierley Street, Leicester. It provides three separate output voltages, namely, 60 volts at 3 mA. for the detector, 80 volts at 1 mA. for screen potential of S.G. valves, and 135 volts at 16 mA. for the power stage. These are not just nominal values, but as near as no matter the actual voltages that will be obtained under working conditions, as we have verified by tests made with a specimen unit.

The 20-mA. model suffices for the majority of receivers hitherto battery operated, and is in every respect a satisfactory substitute. There is very little mains hum, and since separate resistances are used to drop the volts at the intermediate tapplings, additional anode decoupling is not likely to be required.

The makers list also another unit, rated to give 30 mA. output and designated the "Q" 30 model. The price is 50s. Both units embody Westinghouse metal rectifiers.

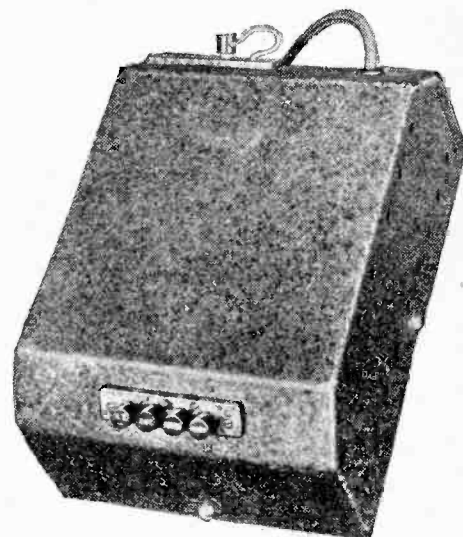

Rectifiers "Q" 20 model H.T. battery eliminator giving a maximum output of 20 mA. at 135 volts.

T.C.C. DRY ELECTROLYTIC CONDENSER

AN 8-mfd. size high-voltage dry electrolytic condenser is now obtainable from the Telegraph Condenser Co., Ltd., Wales Farm Road, North Acton, London, W.3. It is mounted in a tubular aluminium container with the connections so arranged that when assembled on a metal chassis the polarity of the condenser is correct, the case being the negative connection. The positive contact is brought out through an insulated bush which serves also to carry the large fixing nut.

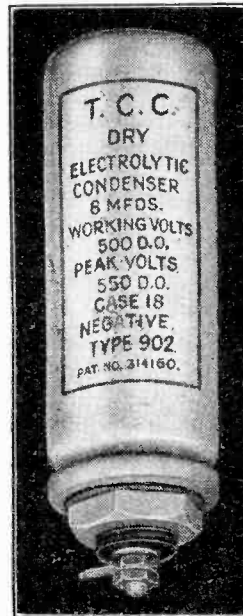

T.C.C. 8 mfd. dry-electrolytic condenser rated at 500-volt D.C. working.

The working potential of this model is 500 volts D.C., and the leakage current is stated by the makers to be less than 0.35 mA. On test we found the initial leakage to be about 2 mA., but it fell within a few minutes to half this value, and thence much more slowly until finally only a fraction of a milliamp. was passing. The price is 9s.

Trade Notes

W. Bryan Savage, 292, Bishopsgate, London, E.C., has now moved into a new model factory at 56-58, Clerkenwell Road, London, E.C.1. The goods entrance is at 25-27, Great Sutton Street.

Additional showroom premises on the ground and first floors of 4, Surrey Street, Strand, have now been taken over by the City Accumulator Co., the offices and works remaining as hitherto at 7, Angel Court, Strand, London W.C.2.

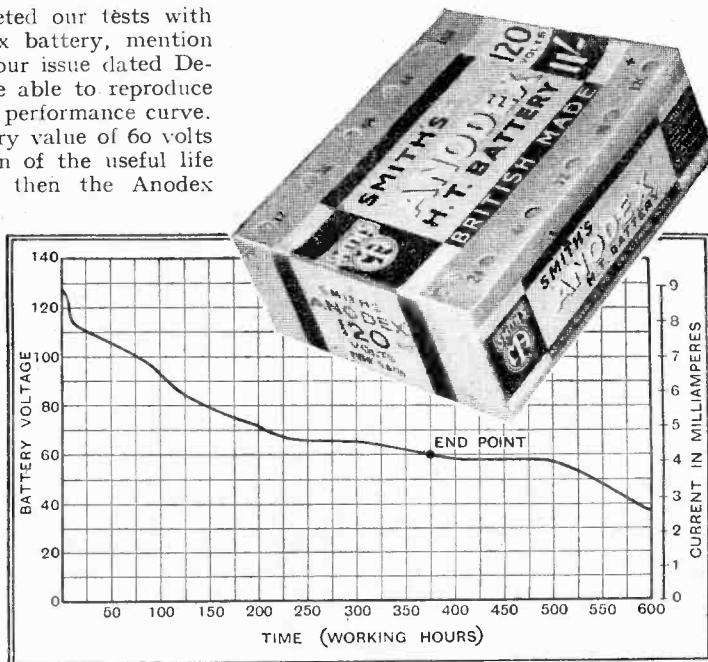

Discharge curve of Smith's Anodex 120-volt dry cell H.T. battery.

BROADCAST BREVITIES

By Our Special Correspondent.

Another Wave for Britain?

ALTHOUGH all doors were sealed at the special meeting at Brussels of the technical committee of the International Broadcasting Union, concluded on Saturday last, I understand that Mr. Noel Ashbridge and Mr. Hayes, representing the B.B.C. and the interests of British listeners, fought a brave battle to secure an extra medium wavelength for this country.

As all the world is supposed to know, but doesn't, the committee was planning proposals, to be submitted before the European postal administrations in May next, for a more or less thorough revision of the Prague Plan.

Not at Inverness

If, as seems likely, Britain secures another wavelength, the B.B.C. will probably build an additional station, though I am less sure than are certain Scottish advocates, that its locality will be Inverness. I should be the first to agree that the North of Scotland has been poorly served by the B.B.C. in the past but, considering the smallness of the population north of the Caledonian Canal, I feel it would be a waste of a good wavelength to set up a main station in a locality which could quite reasonably manage with a relay.

"Scrap the Nationals"

On the other hand, no one would grudge Inverness a wavelength of its own if the new "scrap the Nationals" campaign were successful. The idea is that with 100 kilowatts being radiated from the Droitwich station, the medium-wave National transmitters at Brookmans Park, Moorside Edge and elsewhere would be superfluous, and should therefore be scrapped.

Pros and Cons

Mr. Ashbridge, I understand, is not the sponsor of such a scheme, though it has certain arguments in its favour, not the least important being the opportunity it would give to use the released wavelengths in remote parts of the country which otherwise would still be inadequately served.

But I cannot imagine London taking its National programme from far-away Droitwich, and sitting content.

Sir Henry Wood

NO human activity seems to gather unto itself more rumours and counter-rumours than broadcasting, and I could probably fill a page each week with refutations alone. Take this story of Sir Henry Wood and the move to displace the *Maestro* at the "Prom" concerts in favour of one of the B.B.C.'s own conductors.

At Headquarters I am solemnly advised that the tale contains no truth whatever. For the sake of getting such an assurance I am almost glad that the false rumour appeared.

The Assistant-Controller

ADMIRAL CARPENDALE, Assistant-Controller of the B.B.C., has spent part of his "summer holiday" in Switzerland before proceeding to the U.I.R. technical meeting in Brussels.

The Empire Response

DISCONTENT with the Empire news bulletins is strongly evinced in many of the letters which the B.B.C.'s new circle of listeners are sending to Broadcasting House. In a batch which I inspected last week there was the repeated request for news about British weather. "Tell us what sort of a day you have had in London" is the refrain sounded from places as far apart as Cape Province and Ontario.

Technical Triumph

But, despite some dissatisfaction with the present programme scheme, Empire listeners are almost unanimous on the technical success of the service.

"Almost perfectly received" writes a New Zealander. "Thoroughly satisfactory" exclaims a Beersheba (Palestine) resident, who, incidentally, is outside any particular zone, and can pick up three Daventry transmissions without difficulty!

Even Canada has been more satisfied of late.



SOMETHING WRONG? Criticism of the B.B.C. News Bulletins is not confined to this country. Recent letters from the Empire indicate that the B.B.C. bulletins lack verve and are unsuited to listeners' needs. The photograph was taken in a news studio at Broadcasting House.

Bombardier Wells To-morrow

THE sports talk to be broadcast to-morrow (Saturday) will be given by Bombardier Billy Wells, and will be entitled "Boxing: Giants of Yesterday and Today." Billy Wells was heavyweight boxing champion of Great Britain, 1911-1919.

Chance for Spring Poets

NEARLY two hundred poems addressed to the Prince of Wales have been received at Broadcasting House. They are part of listeners' contribution of a total of more than 2,000 poems submitted in response to the B.B.C.'s enquiry for original works for broadcasting as late evening readings. Poems have come from many parts of the world, and the topic chosen by the largest number of aspirants to broadcasting fame is LOVE.

Safer Course?

And why does the B.B.C. want your poems? I will tell you. The Corporation, being anxious to broadcast poetry late at night, would like to send out listeners' own compositions, though I understand that there is no intention to evade responsibility in the matter.

Five Days More

Listeners are accordingly invited to submit poems for consideration, and this invitation extends until February 28: poems received after this date cannot be considered. Poems must be original and hitherto unpublished compositions; there is no restriction of subject, but no poem should be sent in which cannot be read within the space of five minutes, and not more than three poems should be sent in by any one listener.

Envelopes should be marked "Poetry."

Stretcher-bearers!

I USED to think that the uniformed nurse so often to be seen flitting about Broadcasting House was there to administer to minor aches and pains. The duties are sterner, however, and include the treatment of broken limbs and possibly necks, for the casualty list is high. Slippery stairs and sharp, unexpected corners have brought about the downfall of many athletic young persons on the B.B.C. staff, and no one knows whose turn will come next.

Miniature Opera

TWO miniature operas by Mozart are to be produced by Gordon McConnel in the National programme on March 17th (Regional, March 18th). They are the lyric pastorella, "Bastien and Bastienne," and the comedy opera, "The Impresario," the English adaptation being by Eric Blom. Dr. Adrian Boulton will conduct the B.B.C. Orchestra, Section C (thirty-eight players).

Mr. Malcolm Frost

I AM sorry to hear that Mr. Malcolm Frost, the B.B.C. Empire "Ambassador," has not thoroughly recovered from his attack of malaria at Capetown. The world tour is being cancelled, at any rate for the present.

Leave Mr. Gill Alone!

THE hundred per cent. efficient persons are beginning to rail at Mr. Eric Gill for spending so long on the statuary over the porch of Broadcasting House. Apparently, it "isn't business," even if you happen to be one of the finest sculptors in Europe, to take too long over one job.

I am glad Mr. Gill refuses to be rushed.

Long-lived Statuary

Mr. Gill knows that Broadcasting House has been built to outlast the century; he wishes his statuary to do the same, so why should he hurry himself?

By the way, I have talked to more than one man who, from wincing at the small bas-reliefs by Gill on the sides of Broadcasting House, now gazes at them with growing pleasure.

READERS' PROBLEMS

THESE columns are reserved for the publication of matter of general interest arising out of problems submitted by our readers. Readers requiring an individual reply to their technical questions by post are referred to "The Wireless World" Information Bureau, of which brief particulars, with the fee charged, are to be found at the foot of this page.

Reaction Circuit Connections

THERE need be no hesitation in mounting a reaction condenser in the most convenient operating position. Even though this procedure may necessitate long connecting leads, all risk of instability may be avoided by shielding these wires.

Similarly, when there is any suspicion that instability is due to long reaction leads, the experiment of shielding these leads may be tried with confidence; the effect of doing so is most unlikely to be in any way prejudicial to the operation of the set.

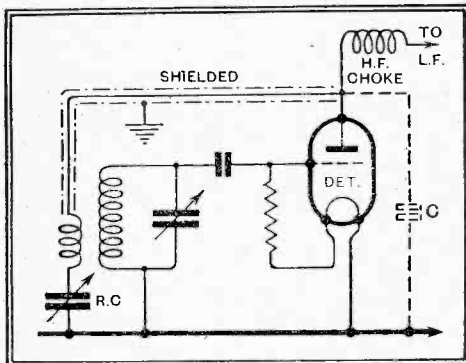

Fig. 1.—The use of a screened lead for the reaction circuit connection has no other effect than the addition of a small capacity (C) between detector anode and earth.

This is in answer to a correspondent who finds that his "2 H.F." set can be stabilised by disconnecting the reaction control circuit; he has satisfied himself that the trouble is not due to the use of a reaction condenser with an excessively high minimum capacity.

This correspondent goes on to ask whether the use of a screened lead to the reaction coil and condenser is likely to have any untoward effects; he is particularly anxious to know whether the extra capacity of the shielded connection is likely further to restrict the tuning range of the receiver.

We would certainly recommend him to try the effect of shielded connections. He can rest assured that the tuning range of the set will not be restricted; in effect, the capacity of a shielded lead from the detector anode will be additive to that already existing between the anode of the detector valve and earth. In this position, a capacity in the neighbourhood of 0.0003 mid.—much more than that of a shielded lead—is likely to be actually beneficial.

The use of a shielded lead between the reaction coil and the "live" side of the reaction condenser will increase slightly the minimum capacity of the condenser; this is most unlikely to prove an unsurmountable drawback.

Erratic Volume Control

DESCRIBING the operation of his volume control, a correspondent tells us that loudness of reproduction is increased progressively until the potentiometer slider reaches a point a few degrees from the end of its travel. After this point there is a slight, but clearly perceptible, falling-off in volume.

A variable- μ valve is used in the receiver, and, according to a circuit diagram submitted by our querist, volume control is effected in a fairly conventional way by variation of the bias applied to this valve. But the usual limiting resistance has been omitted, with the result that when the potentiometer slider is at the "maximum" position, the grid is at zero potential, or at the same potential as the cathode.

This explains the effect described, and we think there can be no doubt that the falling-off in sensitivity is due to the flow of grid current, which imposes a certain amount of damping on the input circuit. As a general rule, maximum sensitivity will be obtained when the grid of the H.F. valve is made just sufficiently negative to prevent the flow of grid current.

"Monodial" Heater Voltage

IN the "A.C. Monodial," current for the indirectly heated valves in the receiver unit is fed through fairly long leads from the power supply unit; it is therefore a matter of some importance that the ohmic resistance of these leads should be low, and, accordingly, in order to prevent undue loss of voltage, two pairs of parallel interconnecting wires were employed. The resistance of these leads is so small that the drop in voltage should amount to very little more than a tenth of a volt, which is negligible.

A reader tells us that he has borrowed a dependable A.C. voltmeter, and finds that the voltage existing across the heaters of his own "Monodial" amounts to very little more than 3.6 volts; he goes on to say that the L.T. voltage measured directly across the transformer terminals is rather over than under 4 volts. He asks whether this indicates an excessive loss of voltage.

We are afraid that it does, and we advise him to lose no time in replacing the inter-unit L.T. leads by others of considerably greater cross-sectional area.

Paralleled Transformer Windings

IT is hardly to be advised that two or more of the separate L.T. windings of a power transformer should be connected in parallel. If the "sense" of the two interconnected windings be incorrect, they would act more

The Wireless World

INFORMATION BUREAU

THE service is intended primarily for readers meeting with difficulties in the construction, adjustment, operation, or maintenance of wireless receivers described in *The Wireless World*, or those of commercial design which from time to time are reviewed in the pages of *The Wireless World*. Every endeavour will be made to deal with queries on all wireless matters, provided that they are of such a nature that they can be dealt with satisfactorily in a letter.

Communications should be addressed to *The Wireless World* Information Bureau, Dorset House, Tudor Street, E.C.4, and must be accompanied by a remittance of 5s. to cover the cost of the service. The enquirer's name and address should be written in block letters at the top of all communications.

or less as a short-circuit, and there is a grave risk that the transformer would be burnt out.

Information on this subject is asked for by a reader who wishes to feed six indirectly heated A.C. valves from an existing transformer which has one L.T. winding rated at 4 volts 4 amps., and another at 4 volts 2½ amps. His proposal is to connect all the heating elements of the valves across these two windings after they have been joined in parallel.

Rather than run the risk of damaging his transformer, we suggest that four of the valves should be fed from the 4-amp. winding, and the remaining two from the other. The centre taps of both windings will, of course, be joined to the common earth line in the usual way.

Coupling Condenser Capacity

JUDGING from letters that have recently been received, there appears to be some uncertainty as to the precise effect of using, in a resistance-capacity amplifier, a coupling condenser of smaller capacity than is usually specified. The condenser in question is that marked C in Fig. 2.

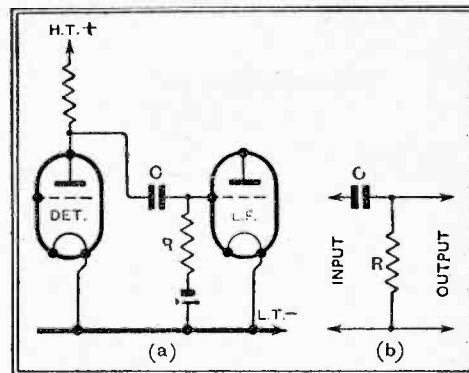

Fig. 2.—A resistance-coupled stage, and (diagram b) the equivalent circuit to show the effect of the coupling condenser.

Used in this position, too small a condenser will have the effect of attenuating proportionately the lower register in relation to the higher audible frequencies.

This is easy to understand if one regards the coupling condenser and its associated grid leak (R in the diagram) as a potential divider connected across the source of input voltage—in this case the anode circuit of the preceding valve. The equivalent circuit, so far as these components are concerned, has been redrawn in Fig. 2 (b). Voltages developed across the condenser are wasted, and only those developed across the grid leak are passed on to the succeeding valve to do useful work.

Now the reactance of a condenser varies with frequency, and the proportion of signal voltage dissipated (and wasted) across the condenser limb of the potentiometer is much greater for low notes than for high; frequency distortion is in this way introduced unless the condenser has a sufficiently high capacity in relation to the grid-leak resistance.